

Double-Sided Chip Resistors

DSC Series

- Two parallel resistance elements in a single chip
- Excellent pulse withstand performance
- Laser trimmed up to 0.5% tolerance
- Enhanced working voltage
- Enhanced power rating
- Pb-free terminations

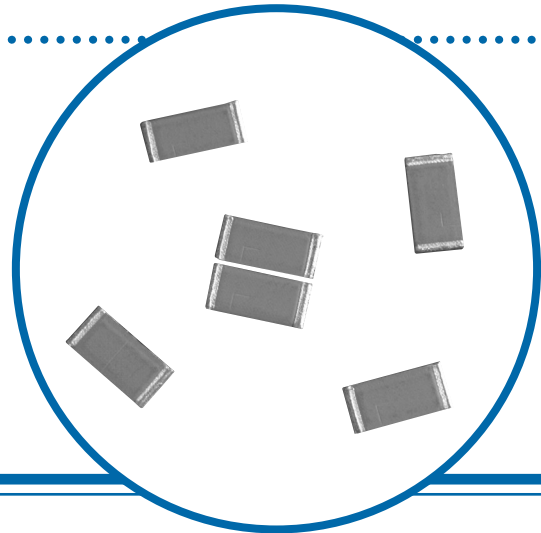

Electrical Data

		1206	2010	2512
Power @70°C	Watts	0.33	0.75	1.5
2 second overload power @25°C	Watts	2.1	4.7	9.4
Short pulse performance		See graphs		
Resistance range	Ohms	1R0 to 4M7		
Tolerance	%	10R to 1M: 0.5, All values: 1, 5		
LEV	Volts	200	400	500
TCR	ppm/°C	<10R:200 ≥10R:100		
Operating temperature	°C	-55 to +155		
Dielectric withstand voltage	Volts	500		
Thermal Impedance	°C/W	160	80	50
Pad & trace area for rated power*	mm ²	50	60	100
Values		E24 or 96 preferred - other values to special order		

*Recommended minimum pad & adjacent trace area for each termination for rated power dissipation on FR4 PCB

Physical Data

Dimensions (mm) & Weight (g)							
	L	W	T max	A	B min	C	Wt.
1206	3.2±0.4	1.6±0.2	0.7	0.4±0.2	1.7	0.4±0.15	0.020
2010	5.1±0.3	2.5±0.2	0.8	0.6±0.3	3.0	0.6±0.25	0.036
2512	6.5±0.3	3.2±0.2	0.8	0.6±0.3	4.4	0.6±0.25	0.055

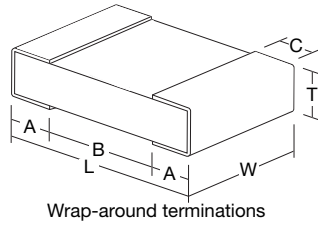

Wrap-around terminations
(3 faces)

Construction

Thick film resistor material, overglaze and organic protection are screen printed on a 96% alumina substrate. Wrap-around terminations have an electroplated nickel barrier and Pb-free solderable coating, this ensures excellent 'leach' resistance properties and solderability.

Marking

Components are not marked. Reels are marked with type, value, tolerance, date code and quantity.

Solvent Resistance

The body protection is resistant to all normal industrial cleaning solvents suitable for printed circuits.

General Note

Welwyn Components reserves the right to make changes in product specification without notice or liability. All information is subject to Welwyn's own data and is considered accurate at time of going to print.

Performance Data

		Maximum	Typical
Load at rated power: 1000 hours at 70°C	$\Delta R\%$	1	0.25
Derating from rated power at 70°C		Zero at 155°C	
Overload: 6.25 x rated power for 2 seconds	$\Delta R\%$	1	0.1
Shelf life test: 12 months at room temperature	$\Delta R\%$	0.1	0.02
Dry heat: 1000 hours at 155°C	$\Delta R\%$	1	0.2
Long term damp heat	$\Delta R\%$	1	0.25
Temperature rapid change	$\Delta R\%$	0.25	0.05
Resistance to solder heat	$\Delta R\%$	0.25	0.05

Note: A 0.01 Ohm addition to be added to the performance of all resistors <10 Ohms.

Pulse Performance Data

Lightning Surge

Resistors have been tested in accordance with IEC 60 115-1 using both 1.2/50 μ s and 10/700 μ s pulse shapes. Also, the 2512 size has been tested to the Bellcore GR1089 2/10 μ s and 10/1000 μ s pulse shapes. The limit of acceptance is a shift in resistance of less than 1% from the initial value.

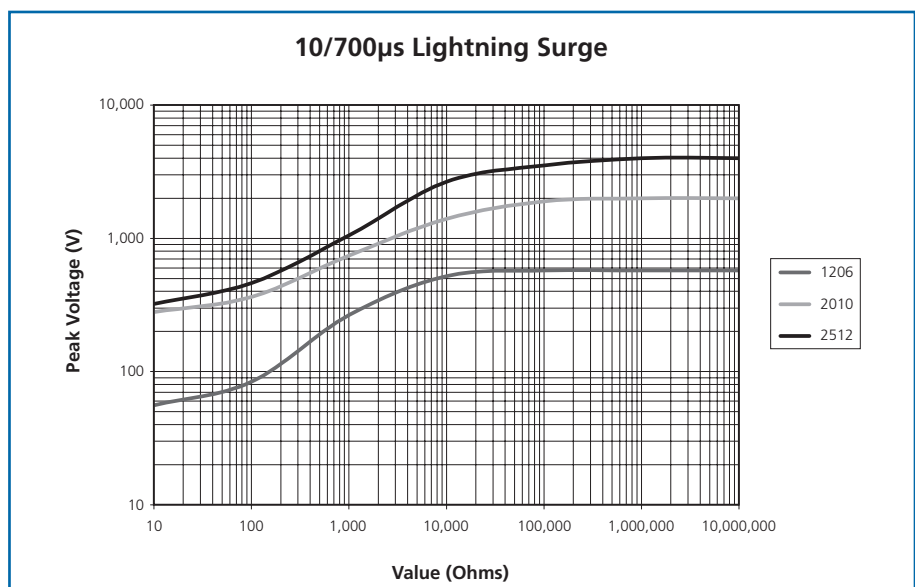
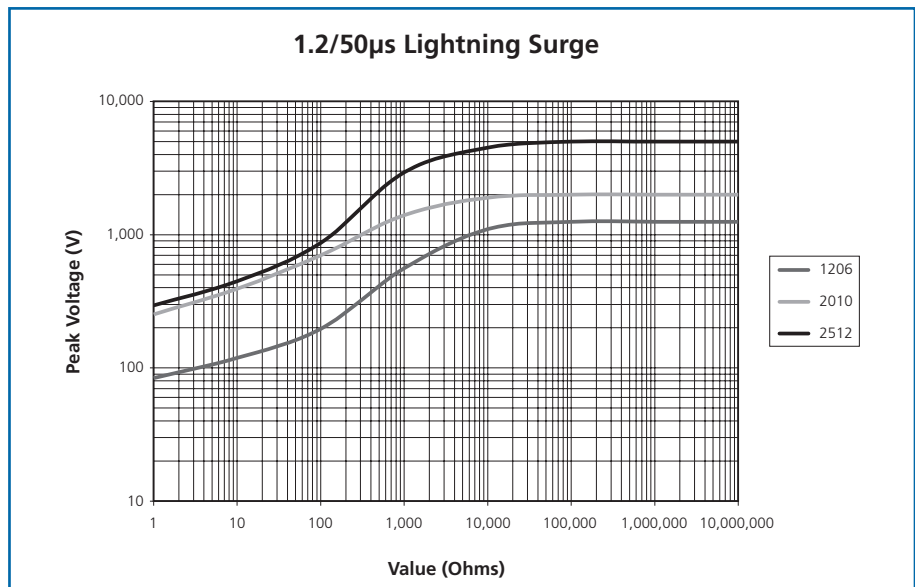

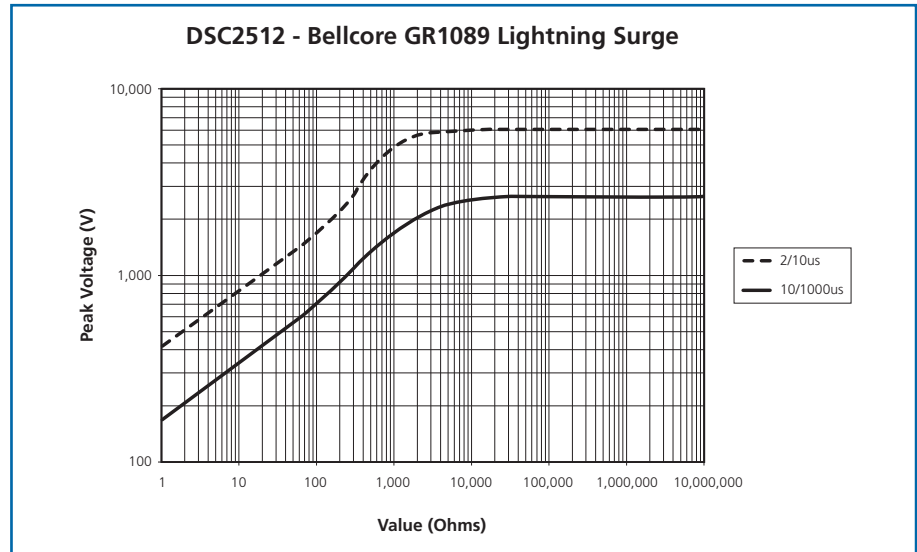

Single Pulse

The single impulse graph is the result of 50 impulses of rectangular shape applied at one-minute intervals. The limit of acceptance was a shift in resistance of less than 1% from the initial value.

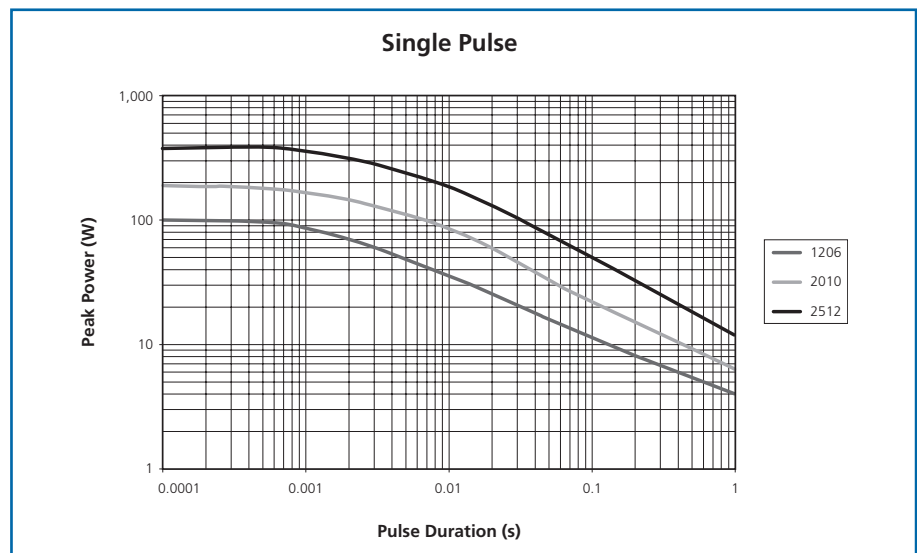

Continuous Load Due to Repetitive Pulses

The continuous load graph was obtained by applying repetitive rectangular pulses where the pulse period was adjusted so that the average power dissipated in the resistor was equal to its rated power at 70°C. Again the limit of acceptance was a shift in resistance of less than 1% from the initial value.

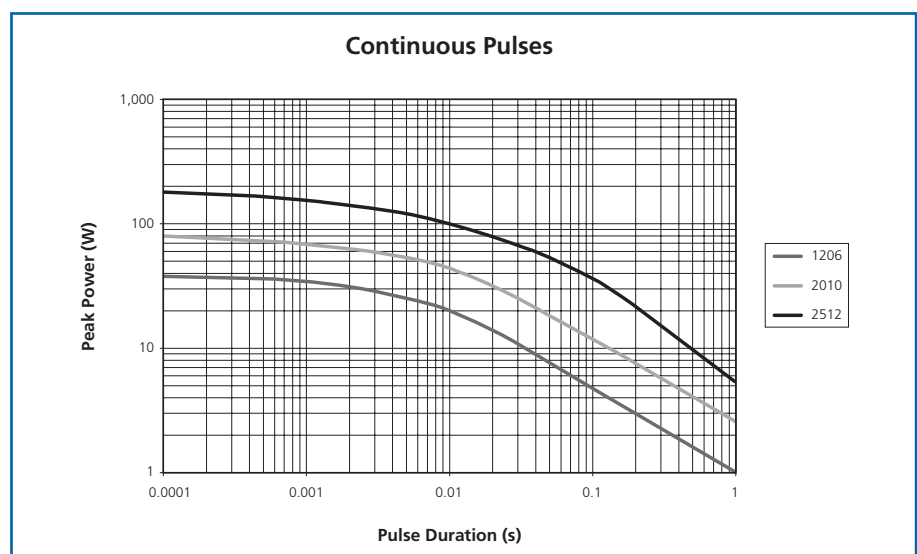

Thermal Performance Data

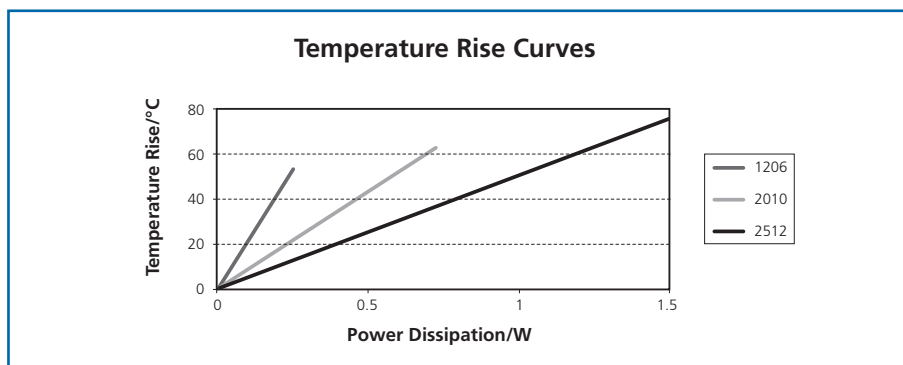
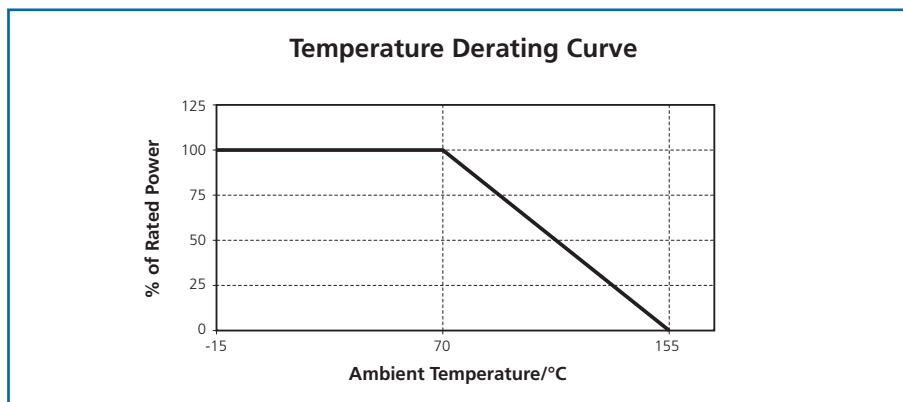

Packaging

1206 DSC series resistors are supplied on 8mm carrier tape and 7 inch reels as per IEC 286-3, quantity per reel; 3000.
 2010 and 2512 DSC series resistors are supplied on 12mm carrier tape and 7 inch reels as per IEC 286-3, quantity per reel;
 2010 : 3000pcs; 2512 : 1800pcs. Reels of 1000pcs are available on request.

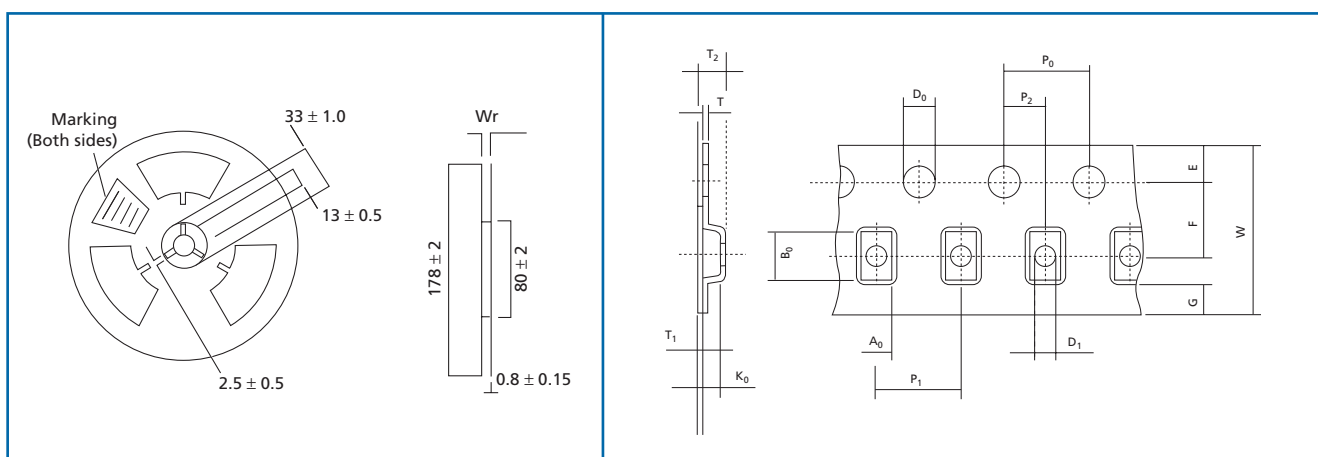

Tape and reel dimensions (mm)														
	W	P1	P0	P2	D0	D1	E	F	A0	B0	K0	T	T1	T2
	±0.3	±0.1	±0.1	±0.05	±0.1	±0.2	±0.1	±0.05	±0.1	±0.1	±0.1	±0.05	nom	±0.15
1206	8	4	4	2	1.5	1	1.75	3.5	1.95	3.55	1.0	0.2	0.05	1.3
2010	12	4	4	2	1.5	1.5	1.75	5.5	2.79	5.89	0.91	0.28	0.06	1.21
2512	12	8	4	2	1.5	1.5	1.75	5.5	3.61	6.96	1.17	0.28	0.06	1.45

Application Notes

DSC resistors are ideally suited for handling by automatic methods due to their rectangular shape and the small dimensional tolerances. Electrical connection to a ceramic substrate or to a printed circuit board can be made by reflow or wave soldering of wrap-around terminations.

Wrap-around terminations provide good leach properties and ensure reliable contact. Due to the robust construction, the DSC can be immersed in the solder bath for 30 seconds at 260°C. This enables the resistor to be mounted on one side

of a printed circuit board and wire-led components applied on the other side. DSC is compatible with typical Pb-free soldering materials and temperature profiles

DSC resistors themselves can operate at a maximum temperature of 155°C. For soldered resistors, the joint temperature should not exceed 110°C. This condition is met when the stated power levels at 70°C and recommended pad and trace areas are used. Allowance should be made if smaller areas of copper are used.

Ordering Procedure

Specify type reference etc as shown in this example of DSC2512 10K ohms 1%.

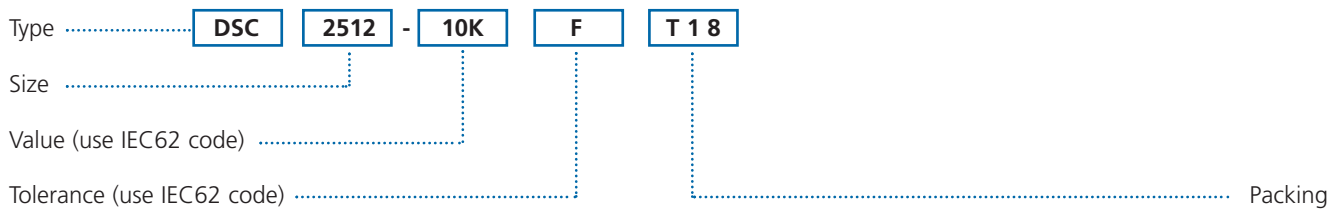

D	0.5%
F	1%
J	5%

T3	Tape	1206 or 2010	3000/reel	Standard
T18		2512	1800/reel	