

MUR480E, MUR4100E

SWITCHMODE™ Power Rectifiers

Ultrafast “E” Series with High Reverse Energy Capability

These state-of-the-art devices are designed for use in switching power supplies, inverters and as free wheeling diodes.

Features

- 20 mJ Avalanche Energy Guaranteed
- Excellent Protection Against Voltage Transients in Switching Inductive Load Circuits
- Ultrafast 75 Nanosecond Recovery Time
- 175°C Operating Junction Temperature
- Low Forward Voltage
- Low Leakage Current
- High Temperature Glass Passivated Junction
- Reverse Voltage to 1000 V
- These are Pb-Free Devices*

Mechanical Characteristics:

- Case: Epoxy, Molded
- Weight: 1.1 Gram (Approximately)
- Finish: All External Surfaces Corrosion Resistant and Terminal Leads are Readily Solderable
- Lead Temperature for Soldering Purposes: 260°C Max. for 10 Seconds
- Shipped in Plastic Bags, 5,000 per Bag
- Available Tape and Reel, 1,500 per Reel, by Adding a “RL” Suffix to the Part Number
- Polarity: Cathode indicated by Polarity Band

MAXIMUM RATINGS

Rating	Symbol	Value	Unit
Peak Repetitive Reverse Voltage Working Peak Reverse Voltage DC Blocking Voltage MUR480E MUR4100E	V_{RRM} V_{RWM} V_R	800 1000	V
Average Rectified Forward Current (Square Wave; Mounting Method #3 Per Note 2)	$I_{F(AV)}$	4.0 @ $T_A = 35^\circ\text{C}$	A
Non-Repetitive Peak Surge Current (Surge Applied at Rated Load Conditions Halfwave, Single Phase, 60 Hz)	I_{FSM}	70	A
Operating Junction and Storage Temperature Range	T_J, T_{stg}	-65 to +175	°C

Stresses exceeding Maximum Ratings may damage the device. Maximum Ratings are stress ratings only. Functional operation above the Recommended Operating Conditions is not implied. Extended exposure to stresses above the Recommended Operating Conditions may affect device reliability.

*For additional information on our Pb-Free strategy and soldering details, please download the ON Semiconductor Soldering and Mounting Techniques Reference Manual, SOLDERRM/D.



ON Semiconductor®

<http://onsemi.com>

ULTRAFAST RECTIFIER 4.0 AMPERES, 800–1000 VOLTS



AXIAL LEAD
CASE 267
STYLE 1

MARKING DIAGRAM

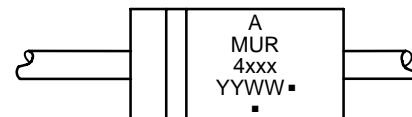

A = Assembly Location
MUR4xxx = Device Number (see page 2)
YY = Year
WW = Work Week
▪ = Pb-Free Package
(Note: Microdot may be in either location)

ORDERING INFORMATION

See detailed ordering and shipping information on page 2 of this data sheet.

MUR480E, MUR4100E

THERMAL CHARACTERISTICS

Rating	Symbol	Value	Unit
Maximum Thermal Resistance, Junction-to-Ambient	$R_{\theta JA}$	See Note 2	°C/W

ELECTRICAL CHARACTERISTICS

Characteristic	Symbol	Max	Unit
Maximum Instantaneous Forward Voltage (Note 1) ($I_F = 3.0$ Amps, $T_J = 150^\circ\text{C}$) ($I_F = 3.0$ Amps, $T_J = 25^\circ\text{C}$) ($I_F = 4.0$ Amps, $T_J = 25^\circ\text{C}$)	V_F	1.53 1.75 1.85	V
Maximum Instantaneous Reverse Current (Note 1) (Rated dc Voltage, $T_J = 150^\circ\text{C}$) (Rated dc Voltage, $T_J = 25^\circ\text{C}$)	i_R	900 25	μA
Maximum Reverse Recovery Time ($I_F = 1.0$ Amp, $di/dt = 50$ Amp/ μs) ($I_F = 0.5$ Amp, $i_R = 1.0$ Amp, $I_{REC} = 0.25$ Amp)	t_{rr}	100 75	ns
Maximum Forward Recovery Time ($I_F = 1.0$ Amp, $di/dt = 100$ Amp/ μs , Recovery to 1.0 V)	t_{fr}	75	ns
Controlled Avalanche Energy (See Test Circuit in Figure 6)	W_{AVAIL}	20	mJ

1. Pulse Test: Pulse Width = 300 μs , Duty Cycle $\leq 2.0\%$.

ORDERING INFORMATION

Device	Marking	Package	Shipping [†]
MUR480E	MUR480E	Axial Lead*	500 Units / Bulk
MUR480EG		Axial Lead*	500 Units / Bulk
MUR480ERL		Axial Lead*	1500 / Tape & Reel
MUR480ERLG		Axial Lead*	1500 / Tape & Reel
MUR480ES	MUR480ES	Axial Lead*	500 Units / Bulk
MUR480ESG		Axial Lead*	500 Units / Bulk
MUR4100E	MUR4100E	Axial Lead*	500 Units / Bulk
MUR4100EG		Axial Lead*	500 Units / Bulk
MUR4100ERL		Axial Lead*	1500 / Tape & Reel
MUR4100ERLG		Axial Lead*	1500 / Tape & Reel

[†]For information on tape and reel specifications, including part orientation and tape sizes, please refer to our Tape and Reel Packaging Specifications Brochure, BRD8011/D.

*This package is inherently Pb-Free.

MUR480E, MUR4100E

MUR480E, MUR4100E

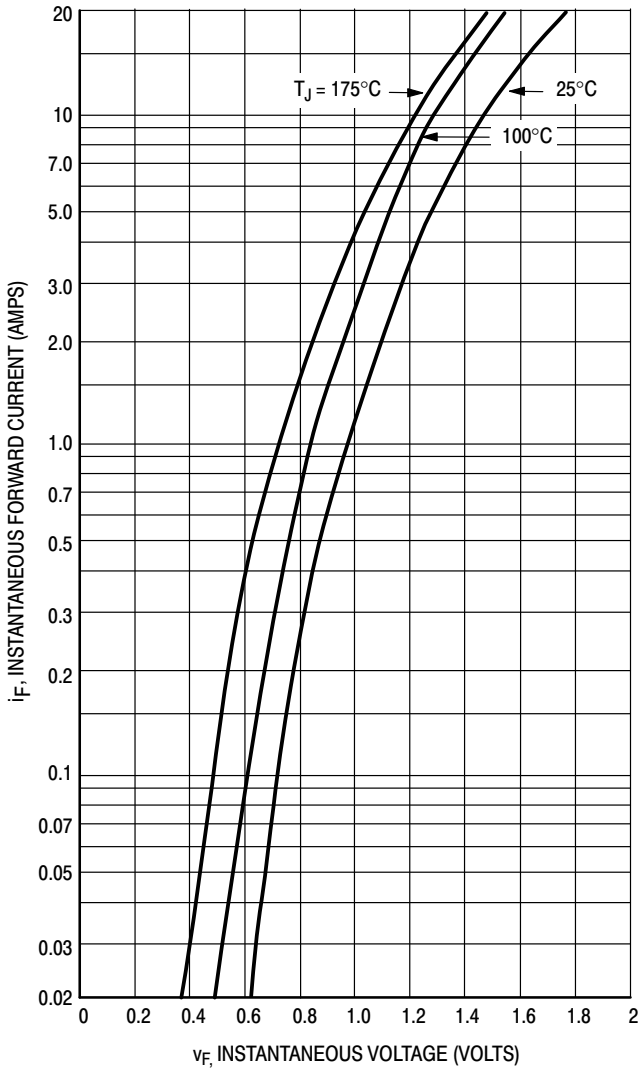

Figure 1. Typical Forward Voltage

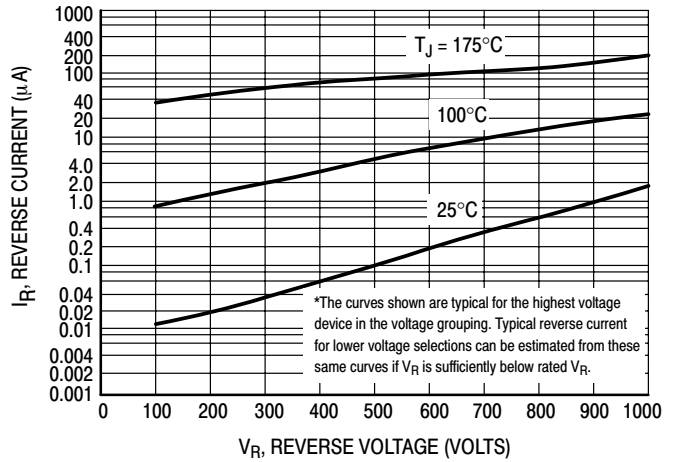

Figure 2. Typical Reverse Current*

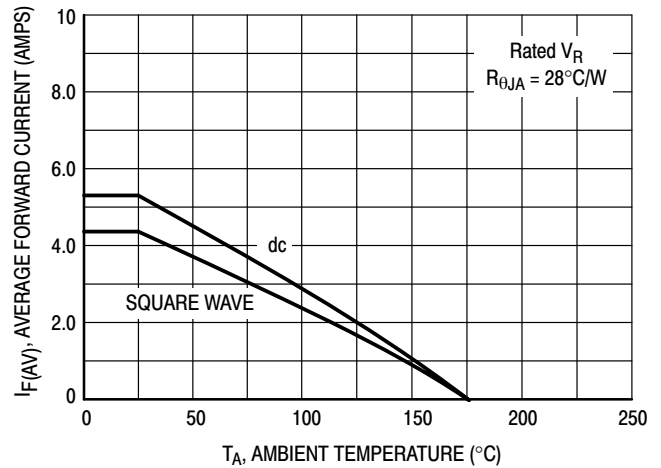

Figure 3. Current Derating
(Mounting Method #3 Per Note 2)

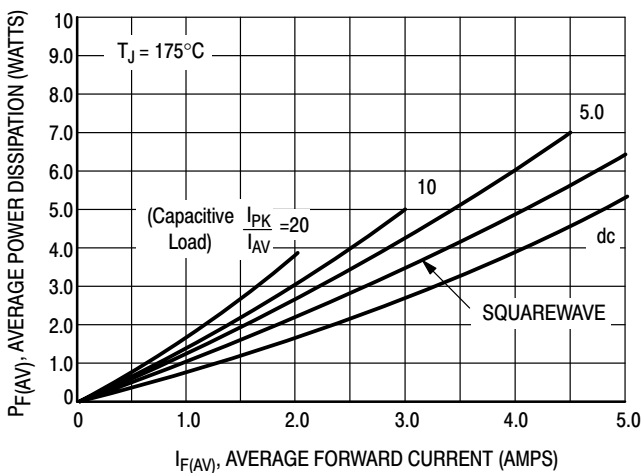

Figure 4. Power Dissipation

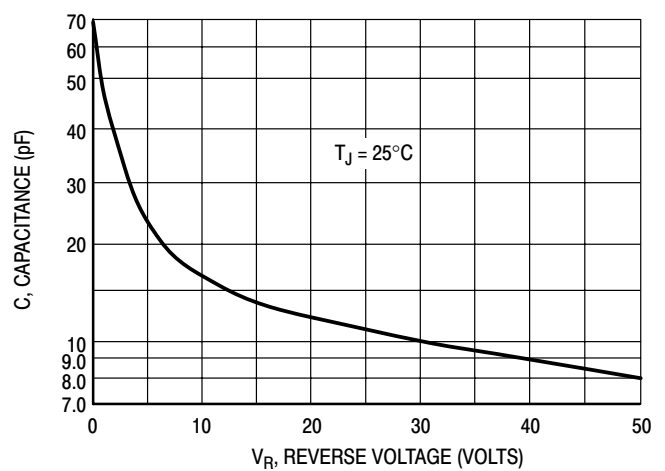

Figure 5. Typical Capacitance

MUR480E, MUR4100E

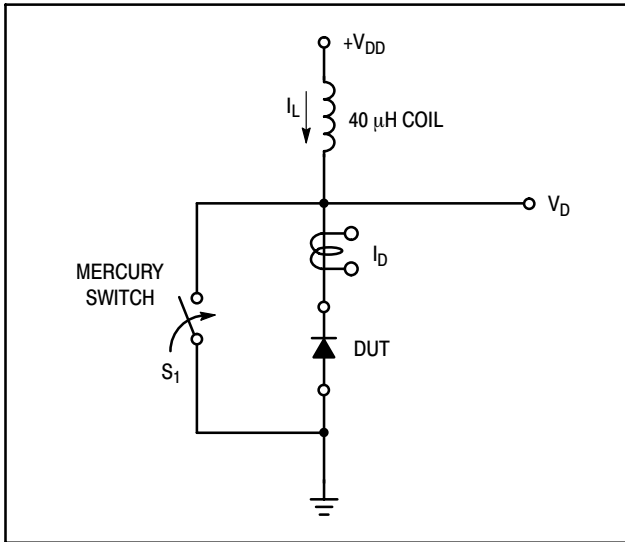

Figure 6. Test Circuit

The unclamped inductive switching circuit shown in Figure 6 was used to demonstrate the controlled avalanche capability of the new “E” series Ultrafast rectifiers. A mercury switch was used instead of an electronic switch to simulate a noisy environment when the switch was being opened.

When S_1 is closed at t_0 the current in the inductor I_L ramps up linearly; and energy is stored in the coil. At t_1 the switch is opened and the voltage across the diode under test begins to rise rapidly, due to di/dt effects, when this induced voltage reaches the breakdown voltage of the diode, it is clamped at BV_{DUT} and the diode begins to conduct the full load current which now starts to decay linearly through the diode, and goes to zero at t_2 .

By solving the loop equation at the point in time when S_1 is opened; and calculating the energy that is transferred to the diode it can be shown that the total energy transferred is equal to the energy stored in the inductor plus a finite amount of energy from the V_{DD} power supply while the diode is in breakdown (from t_1 to t_2) minus any losses due to finite

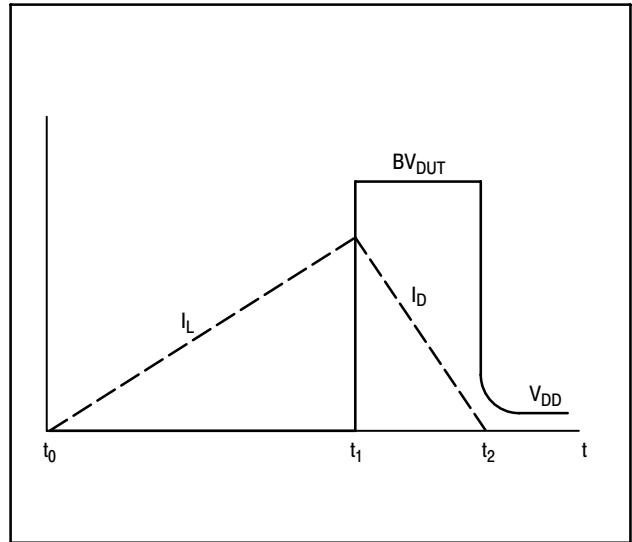

Figure 7. Current–Voltage Waveforms

component resistances. Assuming the component resistive elements are small Equation (1) approximates the total energy transferred to the diode. It can be seen from this equation that if the V_{DD} voltage is low compared to the breakdown voltage of the device, the amount of energy contributed by the supply during breakdown is small and the total energy can be assumed to be nearly equal to the energy stored in the coil during the time when S_1 was closed, Equation (2).

The oscilloscope picture in Figure 8, shows the information obtained for the MUR8100E (similar die construction as the MUR4100E Series) in this test circuit conducting a peak current of one ampere at a breakdown voltage of 1300 V, and using Equation (2) the energy absorbed by the MUR8100E is approximately 20 mjoules.

Although it is not recommended to design for this condition, the new “E” series provides added protection against those unforeseen transient viruses that can produce unexplained random failures in unfriendly environments.

EQUATION (1):

$$W_{AVAL} \approx \frac{1}{2} L I_{PK}^2 \left(\frac{BV_{DUT}}{BV_{DUT} - V_{DD}} \right)$$

EQUATION (2):

$$W_{AVAL} \approx \frac{1}{2} L I_{PK}^2$$

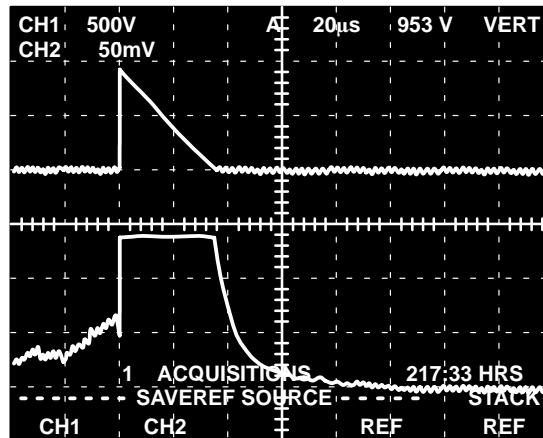

CHANNEL 2:

I_L
0.5 AMPS/DIV.

CHANNEL 1:

V_{DUT}
500 VOLTS/DIV.

TIME BASE:

20 μ S/DIV.

Figure 8. Current–Voltage Waveforms

MUR480E, MUR4100E

NOTE 2 – AMBIENT MOUNTING DATA

Data shown for thermal resistance junction-to-ambient ($R_{\theta JA}$) for the mountings shown is to be used as typical guideline values for preliminary engineering or in case the tie point temperature cannot be measured.

TYPICAL VALUES FOR $R_{\theta JA}$ IN STILL AIR

Mounting Method	$R_{\theta JA}$	Lead Length, L (IN)				Units
		1/8	1/4	1/2	3/4	
1		50	51	53	55	°C/W
2		58	59	61	63	°C/W
3		28				°C/W

MOUNTING METHOD 1

P.C. Board Where Available Copper Surface area is small.

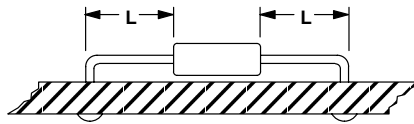

MOUNTING METHOD 2

Vector Push-In Terminals T-28

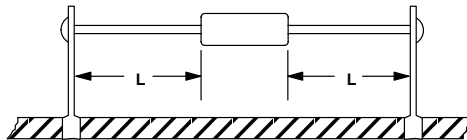

MOUNTING METHOD 3

P.C. Board with 1-1/2" x 1-1/2" Copper Surface

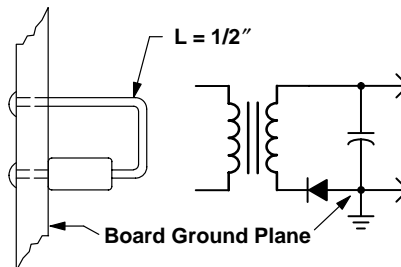

MUR480E, MUR4100E

PACKAGE DIMENSIONS

AXIAL LEAD
CASE 267-05
(DO-201AD)
ISSUE G

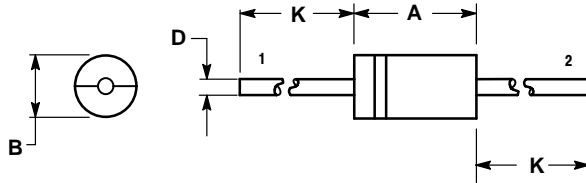

NOTES:

1. DIMENSIONING AND TOLERANCING PER ANSI Y14.5M, 1982.
2. CONTROLLING DIMENSION: INCH.

DIM	INCHES		MILLIMETERS	
	MIN	MAX	MIN	MAX
A	0.287	0.374	7.30	9.50
B	0.189	0.209	4.80	5.30
D	0.047	0.051	1.20	1.30
K	1.000	---	25.40	---

STYLE 1:

1. CATHODE (POLARITY BAND)
2. ANODE

SWITCHMODE is a trademark of Semiconductor Components Industries, LLC.

ON Semiconductor and  are registered trademarks of Semiconductor Components Industries, LLC (SCILLC). SCILLC reserves the right to make changes without further notice to any products herein. SCILLC makes no warranty, representation or guarantee regarding the suitability of its products for any particular purpose, nor does SCILLC assume any liability arising out of the application or use of any product or circuit, and specifically disclaims any and all liability, including without limitation special, consequential or incidental damages. "Typical" parameters which may be provided in SCILLC data sheets and/or specifications can and do vary in different applications and actual performance may vary over time. All operating parameters, including "Typicals" must be validated for each customer application by customer's technical experts. SCILLC does not convey any license under its patent rights nor the rights of others. SCILLC products are not designed, intended, or authorized for use as components in systems intended for surgical implant into the body, or other applications intended to support or sustain life, or for any other application in which the failure of the SCILLC product could create a situation where personal injury or death may occur. Should Buyer purchase or use SCILLC products for any such unintended or unauthorized application, Buyer shall indemnify and hold SCILLC and its officers, employees, subsidiaries, affiliates, and distributors harmless against all claims, costs, damages, and expenses, and reasonable attorney fees arising out of, directly or indirectly, any claim of personal injury or death associated with such unintended or unauthorized use, even if such claim alleges that SCILLC was negligent regarding the design or manufacture of the part. SCILLC is an Equal Opportunity/Affirmative Action Employer. This literature is subject to all applicable copyright laws and is not for resale in any manner.

PUBLICATION ORDERING INFORMATION

LITERATURE FULFILLMENT:

Literature Distribution Center for ON Semiconductor
P.O. Box 5163, Denver, Colorado 80217 USA
Phone: 303-675-2175 or 800-344-3860 Toll Free USA/Canada
Fax: 303-675-2176 or 800-344-3867 Toll Free USA/Canada
Email: orderlit@onsemi.com

N. American Technical Support: 800-282-9855 Toll Free
USA/Canada
Europe, Middle East and Africa Technical Support:
Phone: 421 33 790 2910
Japan Customer Focus Center
Phone: 81-3-5773-3850

ON Semiconductor Website: www.onsemi.com

Order Literature: <http://www.onsemi.com/orderlit>

For additional information, please contact your local
Sales Representative

MUR480E/D