



ELECTRONICS

Product Information

ISSUE DATE : 2002-07-05

MODEL : LTM170EI-V01

Note : This Product information is subject to change after 3 months of issuing date

Prepared by AMLCD Technical Customer Service Team

Samsung Electronics Co . , LTD.

Contents

1. General Description	-----	3
2. Electrical Absolute Ratings	-----	5
3. Environmental Specification	-----	5
4. Optical Characteristics	-----	6
5. Electrical Specification		
5.1 Input video and sync signal	-----	7
5.2 Input Signal Pin Assignment	-----	8
5.3 Function Key Pin Assignment and Description	-----	8
5.4 Power Supply	-----	9
5.4.1 Pin Assignment and description	-----	9
5.4.2 Input voltage & Rush current	-----	9
5.4.3 DPMS: VESA DPMS compliance	-----	9
5.5 Power Consumption	-----	9
5.5.1 Measurement of power consumption	-----	9
5.5.2 Power management mode: VESA DPMS protocol applied	-----	10
6. User Interface	-----	11
6.1 OSD Key Matrix	-----	11
6.2 User Controls	-----	11
7. Microprocessor	-----	12
8. Mechanical Specification		
8.1 Outline dimension	-----	14
8.2 Packing Information	-----	16
9. GENERAL PRECAUTION	-----	18
9.1 Handling	-----	18
9.2 Storage	-----	18
9.3 Operation	-----	18
9.4 Others	-----	19

1. General Description

LTM170EI-V01 is a new concept of System-On-Panel (SOP) display device. It provides total and high quality TFT-LCD display solutions for customer system design. Customer can use the high quality display unit just like an integrated circuit (IC).

As ICs are used as building blocks of many complicated electronic systems, this new display solution can be used just same.

This device includes the high quality TFT-LCD panel and the high brightness 4-lamp backlight unit with the optimized inverter. Integrated signal processing unit, named LSP (LCD Signal Processor™), includes all electronic function for user application. It includes analog-to-digital conversion, NTSC/PAL/SECAM video decoding, Scaling, OSD, EDID (DDC 2 compliance) and LCD Timing controller. More functions are available, also.

World-top notebook LCD design technology of Samsung realize the most compact solution. Customer can enjoy wide system design flexibility.

EMI is the additional point of this device. All of the units are shielded by metal case finally.

* Features

- High display quality : High contrast ratio, Wide-viewing angle and High-speed response time.
- High brightness with the 4-CCFL backlight lamps using optimized inverter.
- On Screen Display(OSD): Samsung generic bitmap OSD is supported, but the customized OSD is also available using system development tool.
- Digital Image Processor is embedded with intelligent microprocessor.
- Wide Input Voltage Range : +10VDC ~ +15VDC
- DDC Ver. 2 Compliance by system integrator
- VESA DPMS compliance
- Low Power Consumption
- Easier EMI troubleshooting and solution supported.
- Easy Lamp replacement

* Information

Items	Specification	Unit	Note
Display area	337.92(H) x 270.336(V)	mm	17.0 inch diagonal
Driver element	a-Si TFT active matrix		
Display colors	16.2M (true)	colors	6-bit FRC
Number of pixels	1280x1024	pixel	
Pixel arrangement	RGB vertical stripe		
Pixel pitch	0.264(H) x 0.264(W)	mm	
Display mode	Normally White		
Surface treatment	Haze 25% , Hard-coating (3H)		
Backlight	4 Lamps		

*** Explanation for Product code**

L T M 1 7 0 E I -V01 -

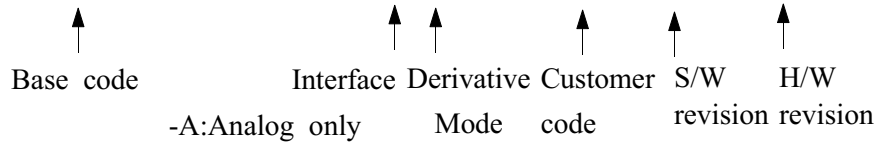

*** System Block Diagram**

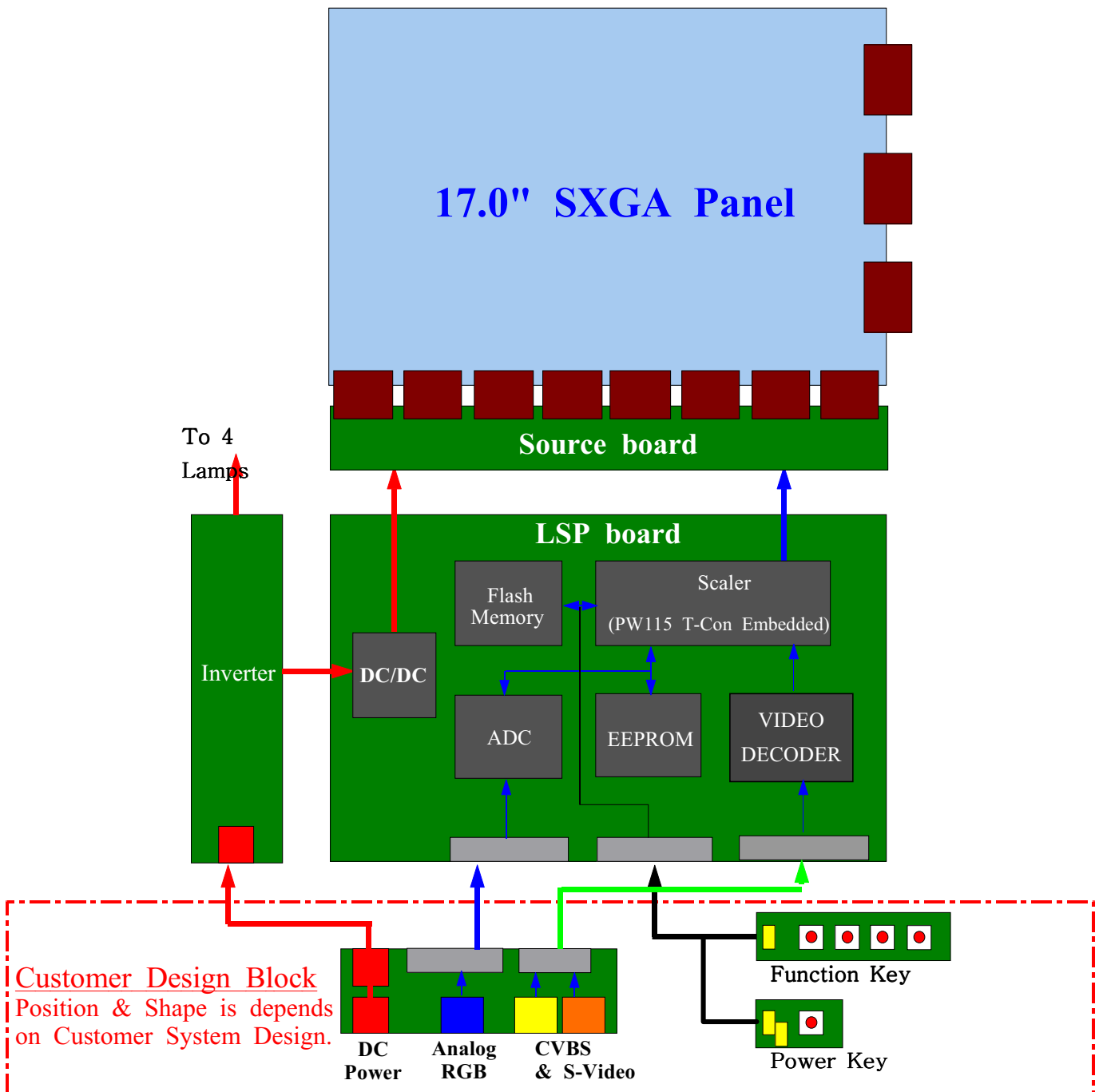

*** Mechanical information**

Item		Min.	Typ.	Max.	Note
Module size	Horizontal(H)	383.0	383.5	384.0	mm
	Vertical(V)	298.1	298.6	299.1	mm
	Depth(D)	-	-	19.5	mm
Weight		-	-	2200	g

2. Electrical Absolute Ratings

(1) TFT LCD Module

(V_{SS} = GND = 0 V)

Item	Symbol	Min.	Max.	Unit	Note
Power Supply Voltage	VDD	-0.3	+21	V	(1)

NOTE (1) Within Ta (25 ± 2 °C)

3. Environmental Specification

Items	Min.	Max.	Units	Note
Storage Temperature	-25	+60	°C	
Operating Temperature	0	+50	°C	
Shock (Non-operating)	-	50	G	11ms, 1 time for ±X, ±Y, ±Z
Vibration (Non-operating)	-	1.5	G	10-300Hz, Sweep rate:10min, 30min for X, Y, Z axis

■ Note: If this product is used for extended time excessively or exposed to high temperatures for extended time, there is a possibility of wide viewing angle film damage which could affect visual characteristics.

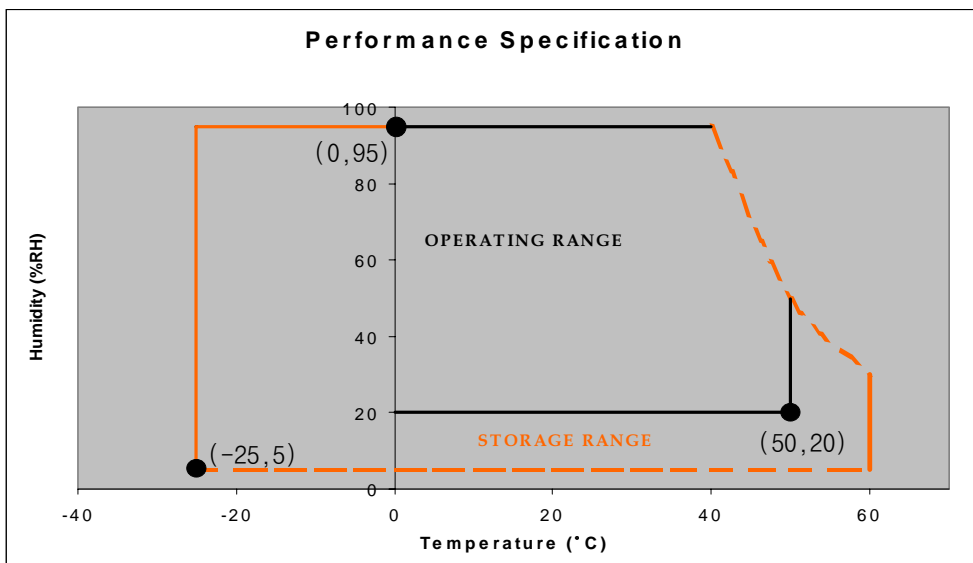

4. Optical Characteristics

The following items are measured under stable conditions. The optical characteristics should be measured

in a dark room or equivalent state with the methods shown in Note (1).

※Measuring equipment : TOPCON BM-5A: Contrast Ratio, Luminance of White, Viewing Angle

TOPCON BM-7: Response time

Photo Research PR650: Color Chromaticity

※Ta = 25± 2℃ , VIN = +12V, fv= 60Hz

Item	Symbol	Condition	Min	Typ	Max	Unit	Note	
Contrast Ratio	CR	Φ=0, Θ=0 Normal Viewing Angle	250	-	-		(1),(2),(4)	
Response Time at Ta	Rising		T _R	-	5	-	msec	(1),(3)
	Falling		T _F	-	20	-		
Luminance of White (Center of Screen)	Y _L			200	250	-	cd/m ²	(1),(4)
Color Chromaticity (CIE 1931)	Red		R _X	T.B.D	0.631	T.B.D		(1), (4)
			R _Y		0.354			
	Green		G _X		0.294			
			G _Y		0.596			
	Blue		B _X		0.143			
			B _Y		0.087			
	White	W _X	0.300					
		W _Y	0.340					
Viewing Angle	Hor.	Θ _L	60	65	-	Degrees		
		Θ _R	60	65	-			
	Ver.	Φ _H	50	55	-			
		Φ _L	50	55	-			
Color Gamut			-	65	-	%		
Brightness Uniformity (9 points)	B _{UNI}		-	-	25	%	(5)	
Cross Modulation	C _T		-	-	5	%	(6)	

■ Measuring Condition: Maximum value of Brightness and Contrast in OSD menu.

5. Electrical Specification

5.1 Input video and sync signal

* Signal Connector : S13B-PH-SM3-TB (JST)

☞ Mating Connector : PHR-13

Item		Description	Notes
Video	Input	<ul style="list-style-type: none"> · Type: Analog RGB · level : 0.7V_{p-p} ±5% · Polarity: Positive Bright · Impedance: 75Ω±10% (Terminated) 	VESA Compliance
	Resolution	<ul style="list-style-type: none"> · Optimum: 1280×1024@60Hz · Maximum: 1280×1024@75Hz 	
	Horizontal Frequency	<ul style="list-style-type: none"> · 30-80KHz 	
	Vertical Frequency	<ul style="list-style-type: none"> · 55-75Hz 	
	Applicable Bandwidth	<ul style="list-style-type: none"> · Typical: 65MHz (1280x1024@60Hz) · Max: 108MHz (1280x1024@75Hz) 	
	Sync Signal	<ul style="list-style-type: none"> · Type: Separate H/V sync, Composite H/V sync · Level: TTL level (V high ≥ 2.0V, V low ≤ 0.8V) · Polarity: Positive or negative · Termination resistance: more than 2KΩ 	
Sync	Input	<ul style="list-style-type: none"> · Type : separate H/V sync, Composite H/V sync · Level : TTL level (V high ≥ 2.0V, V low ≤ 0.8V) · Polarity : Positive or negative. 	

5.2 Input Signal Pin Assignment and Description

* Signal Connector : S13B-PH-SM3-TB (JST)

☞ Mating Connector : PHR-13

Group	Pin No.	Pin Name	Description	Note
Analog RGB	Pin 01	DB_DET	Cable Detect Pin	Internally Pull-Up (Connect this pin with DSUB #5 pin)
	Pin 02	DB_SDA	Serial Data for DDC	
	Pin 03	DB_SCL	Serial Clock for DDC	
	Pin 04	RGND	Red Ground	
	Pin 05	DB_RED	Red Data Input	
	Pin 06	GGND	Green Ground	
	Pin 07	DB_GRN	Green Data Input	
	Pin 08	BGND	Blue Ground	
	Pin 09	DB_BLU	Blue Data Input	
	Pin 10	NC	Not used	
	Pin 11	DB_VSY	Vsync Input	
	Pin 12	SGND	Sync Ground	
	Pin 13	DB_HSY	Hsync Input	

* Video Signal Connector : 53261-1090 (MOLEX) ☞ Mating Connector : 51021-1000 (MOLEX)

Group	Pin No.	Pin Name	Description	Note
Video Composite S-video	Pin 01	VGND1	Ground	
	Pin 02	LUMA	S-Video(Y Signal Input)	
	Pin 03	VGND2	Ground	
	Pin 04	COMP	Composite Video Input	
	Pin 05	VGND3	Ground	
	Pin 06	CHROMA	S-Video(C Signal Input)	
	Pin 07	VGND4	Ground	
	Pin 08	COMPT	Analog Video Input	
	Pin 09	SCL	Serial Clock Input	Internally Pull-Up
	Pin 10	SDA	Serial Data Input/Output	Internally Pull-Up

5.3 Function Key Pin Assignment and Description

* Connector type: 53261-1490 (MOLEX)

☞ Mating Connector: 51021-1490

Group	Pin No.	Pin Name	Description
Keypad	Pin 01	KVDD	Keypad Unit Power
	Pin 02	KGND 1	Keypad Unit Ground
	Pin 03	KEY8	Key Input #8
	Pin 04	KEY7	Key Input #7
	Pin 05	KEY6	Key Input #6
	Pin 06	KEY5	Key Input #5
	Pin 07	KEY4	Key Input #4
	Pin 08	KEY3	Key Input #3
	Pin 09	KEY2	Key Input #2
	Pin 10	KGND 2	Keypad Unit Ground
	Pin 11	KEY1	Key Input #1
	Pin 12	KGND 3	Keypad Unit Ground
	Pin 13	LED1	Status Indicator
	Pin 14	LED2	Status Indicator

5.4 Power Supply

5.4.1 Pin Assignment and description

*Connector type: 40006WR-02 (YeonHo Electronics)

Pin No.	Pin Name	Description	Note
1	Vin	Input Power, +12VDC (typ.)	
2	GND	Ground	

5.4.2 Input voltage & Rush current

Items	Symbol	Min.	Typ.	Max.	Unit
Input Volage	Vin	+10	+12	+15	V
Rush Current	Irush	-	-	+12	A

5.4.3 DPMS: VESA DPMS compliance

5.5 Power Consumption

5.5.1 Measurement of power consumption

☞ Normal mode (Power on): 20Watts (typ.)

Voltage	Current				Resolution
	Min.	Typ.	Max.	Unit	
10V	-	3.2	3.7	A	1280*1024@60Hz
12V	-	2.7	3.1	A	
15V	-	2.1	2.5	A	

☞ Power saving(Stand-by, Suspend, Off mode): less than 3 watts. Monitor has to be recovered to normal operation mode within 4 seconds when normal signal is applied from signal source.

☞ Maximum condition

- OSD condition : Brightness 100, Contrast 100
- test pattern : One pixel on/off (1dot) pattern

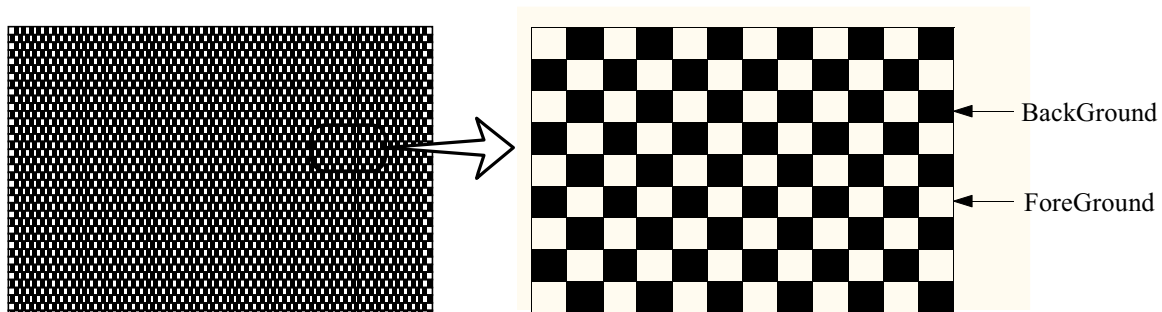

5.5.2 Power management mode: VESA DPMS protocol applied.

Mode	Horizontal sync	Vertical sync	LED1	LED2	Power consumption
On	Active	Active	Off	On	32 watts(Typ.)
Stand-by	Inactive	Active	On/Off (Blinking)	On	< 3 watts
Suspend	Active	Inactive			
Off	Inactive	Inactive			

6. User Interface

6.1 OSD Key Matrix

※This table is based on OSD S/W presented by SAMSUNG.

If our customer wants their customized OSD, Key matrix will be changed.

Input Connector		Keypad
Pin No.	Pin Name	Function
Pin 01	KVDD	+3.3V / 100mA
Pin 02	KGND1	
Pin 03	KEY8	"AUTO"
Pin 04	KEY7	"EXIT" (Source)
Pin 05	KEY6	"LEFT"
Pin 06	KEY5	
Pin 07	KEY4	
Pin 08	KEY3	"RIGHT"
Pin 09	KEY2	"MENU"
Pin 10	KGND2	
Pin 11	KEY1	"POWER"
Pin 12	KGND3	
Pin 13	LED1	LED1
Pin 14	LED2	LED2

* Firmware(including OSD) presented by SAMSUNG is edited by SDK 2.1a

* () : Hot Key

6.2 User Controls

- * Power: Turn on and off the monitor power.
- * Menu: Calls OSD menu and select the function to be adjusted.
- * Auto: Activates "Auto adjustment is being process".
- * Exit/Source
 - ☞ Exit from the OSD function or Back to previous menu.
 - ☞ Selects input signal source by press directly without OSD menu.
- * Left/Right
 - ☞ Moves the selector left and right on the OSD menu.
 - ☞ Increase or decrease the value of selected adjustment or Select proper setting.
- * LED: Indicates the status of monitor operation.
 - ☞ LED2: Normal
 - ☞ Black: Power OFF
 - ☞ LED1: Disconnection of signal cable.
 - ☞ LED1-blinking & LED2 -On : Power Saving Mode.
- * Hot Key
 - ☞ Brightness : Adjust the brightness of back light lamp by press the Left or Right buttons without OSD menu.
 - ☞ Burn-in mode : Press "Menu" and "Exit" during 3 second
If you exit this function mode, press "Menu + Exit".
 - ☞ Software information check : Press "Left" and "Exit" key during 3 second.

7. Microprocessor

* Mode Detection

The microprocessor has to recognize the input signal mode automatically once input signal comes from the signal source, and then has to optimize the display adjustment accordingly integrated auto adjustment procedure.

If microprocessor finds out the input mode from internal NVRAM, all register sets will be initialized with this latest values, but microprocessor has to optimize all register sets with pre-set values if it does not exist in internal NVRAM.

* Auto Adjustment

When user activates the auto adjustment function by pressing AUTO button, the microprocessor will optimize all display adjustment sets such as video offset, gain, position, phase, and frequency automatically according to pre-programmed auto adjustment program.

* Manual Adjustment

If the microprocessor does not optimize all adjustments successfully, the manual adjustment will allow the correction of image adjustment along with OSD functionality. This adjustment has to be described in the user manual correctly.

* Saving Adjustment

The microprocessor manages to save all adjustment results automatically into external NVRAM when adjustment is finished.

* Out of Range (In Case Of SXGA)

The microprocessor has to manage all input signals to figure out the data identification. If the input signal is out of permitted frequency, the microprocessor has to protect all circuitry to avoid any electrical problem, and then has to display the warning message according to pre-programmed message like "Please re-configure the display timing of your system".
But, it will not allow to enter DPMS mode.

This system will judge the input signal as follow the below;

☞ Horizontal frequency: <28KHz, >97KHz

☞ Vertical frequency : >42Hz, <54Hz, >101Hz

* Display Mode (Normal and Failsafe mode) (In Case Of SXGA)

If the input signal is in the permitted frequency range as below, it will be operated in normal mode.

☞ Normal mode

→ Horizontal frequency : 30-81KHz

→ Vertical frequency : 55-77Hz

But, if the input signal is higher than normal input frequency, it will be converted into Fail Safe mode to allow reconfiguration of monitor setting using Windows control panel menu. This functionality will minimize the installation failure by end-user.

☞ Fail Safe mode

→ Horizontal frequency : 81-97KHz

→ Vertical frequency : 76-100Hz

* **Brightness Adjustment**

The system has two kinds of brightness adjustment modes as below;

☞ Normal operation: The brightness of back light has to be adjusted by pressing designated key.

☞ *Smart Inverter Control™*: This function allows the system to adjust the brightness of back light automatically in conjunction with the quantity of the input data using embedded digital processing logic when this mode is activated.

User can set this mode in OSD menu.

Smart Inverter control mode is not implemented yet

* **Power Management**

This system's power management protocol follows VESA DPMS compliance in section of 2.5.3 "Power management", but it has to be managed along with the below horizontal and vertical frequency guide line to identify the sync signal status.

☞ Stand-by mode: Horizontal frequency < 10KHz, Vertical frequency > 40Hz, maintain more than 3 seconds.

☞ Suspend mode: Horizontal frequency > 10KHz, Vertical frequency < 40Hz, maintain more than 3 seconds.

☞ Power-off mode: Horizontal frequency < 10KHz, vertical frequency < 40Hz, maintain more than 3 seconds.

* **Factory Reset**

One designated key allows to reset all data sets into factory preset values. But, it is not allowed to get the previous user set status after this function is finished.

The system has to have this factory preset values prior to shipment to our customer.

* **DDC (EDID)**

This system has one dedicated DDC ROM on the circuitry board. The final monitor system company can installed the EDID data as refer to attachment 2 "EDID Specification" into this ROM through the serial port of VGA connector.

8. Mechanical Specification(T.B.D)

8.1 Outline dimension

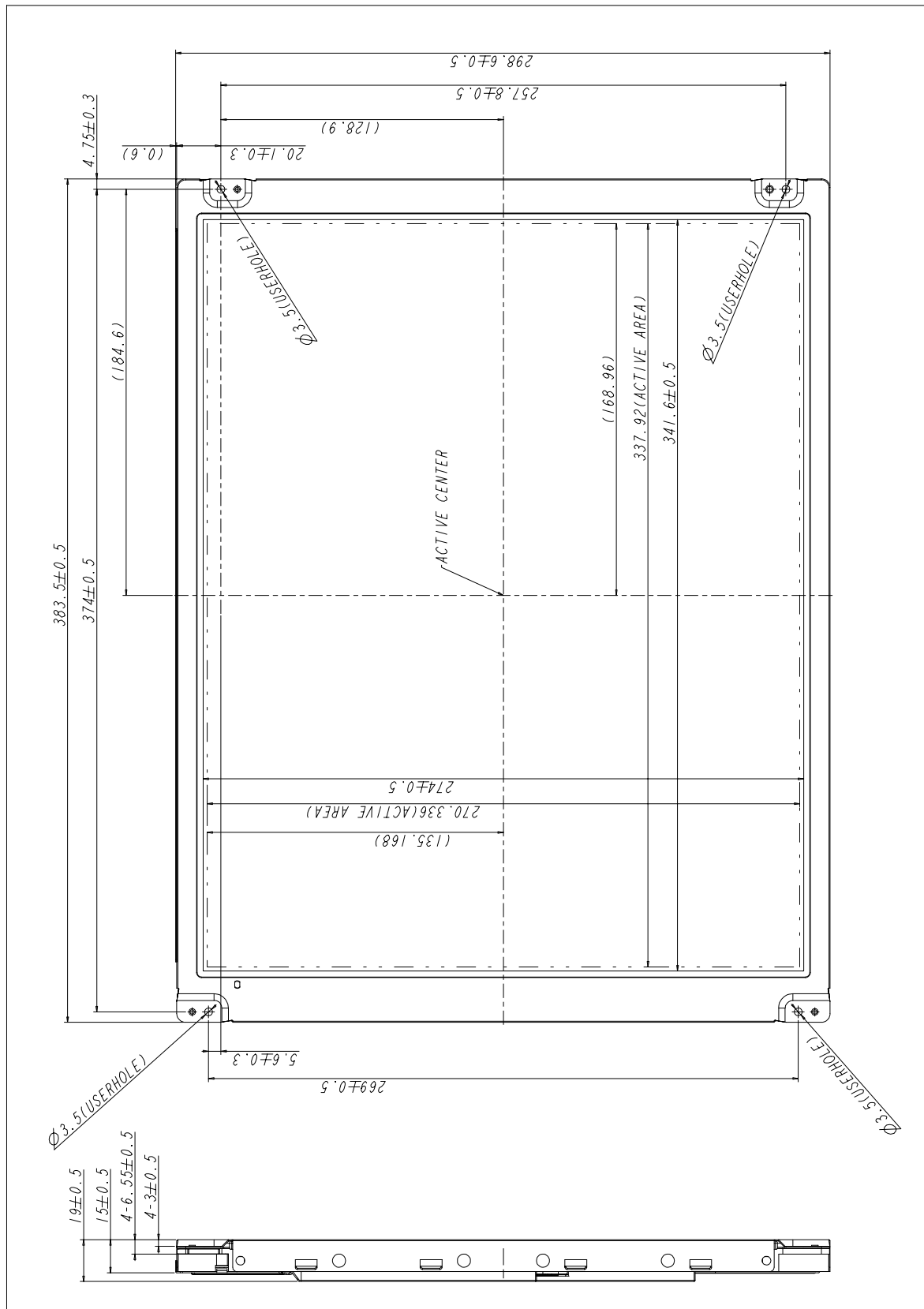

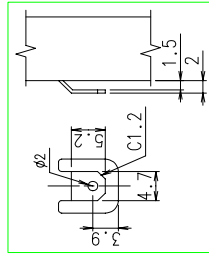
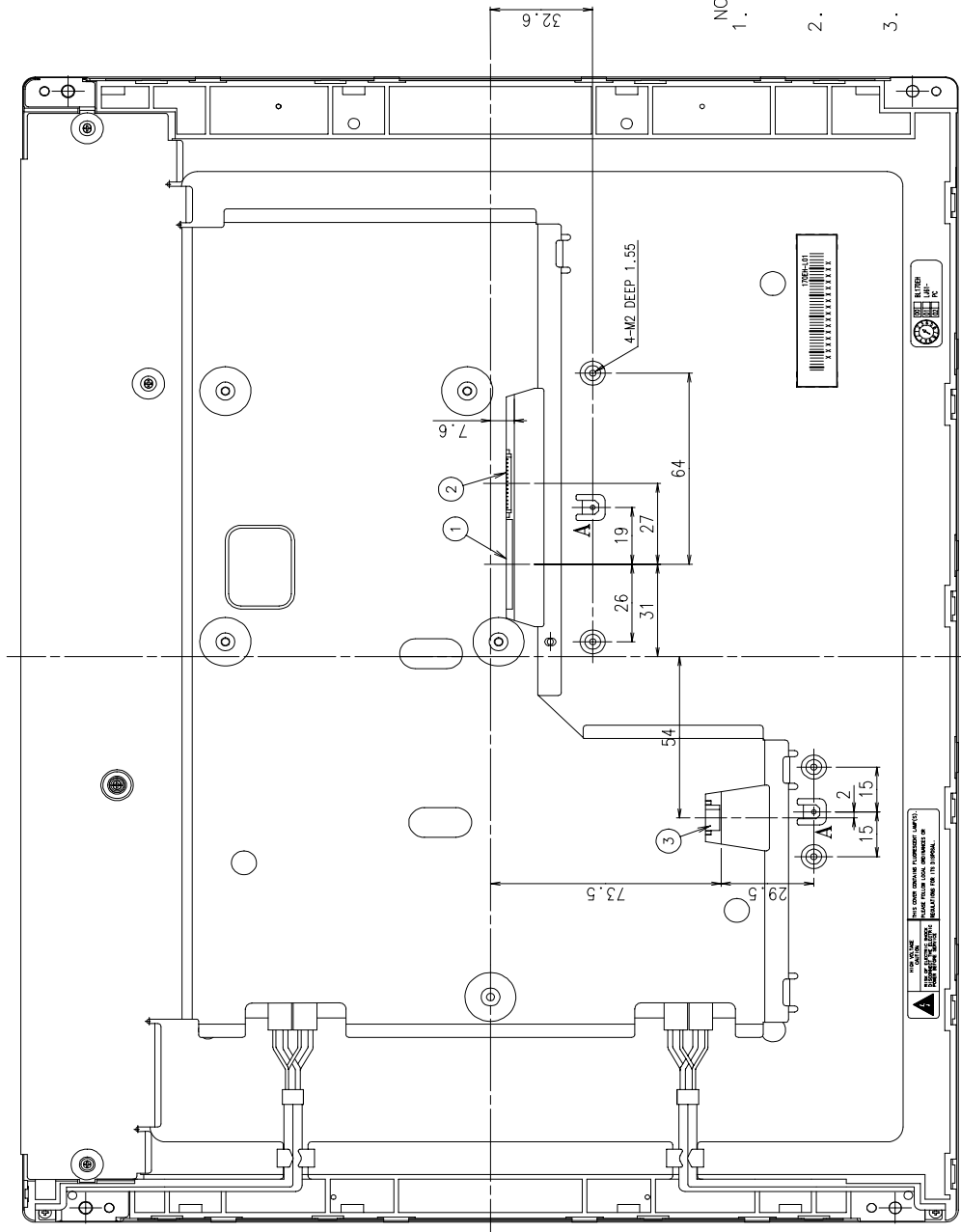

DETAIL "A" (S=2/1)

NOTES

1. NO.1 is Signal interface connector
 Maker : JST
 Part Name : S13B-PH-SM3-TB
 Mating Connector : PHR-13
2. NO.2 is Signal interface connector
 Maker : Molex
 Part Name : 53261-1490
 Mating Connector : 51021-1400
3. NO.3 is Power connector
 Maker : Yeonho
 Part Name : 4006WR
 Mating Connector : 400006

8.2 Packing Information

8.2.1 Carton (Internal Package)

8.2.1.1 Packing Form: Corrugated fiberboard box and corrugated cardboard as shock absorber.

8.2.1.2 Packing Method

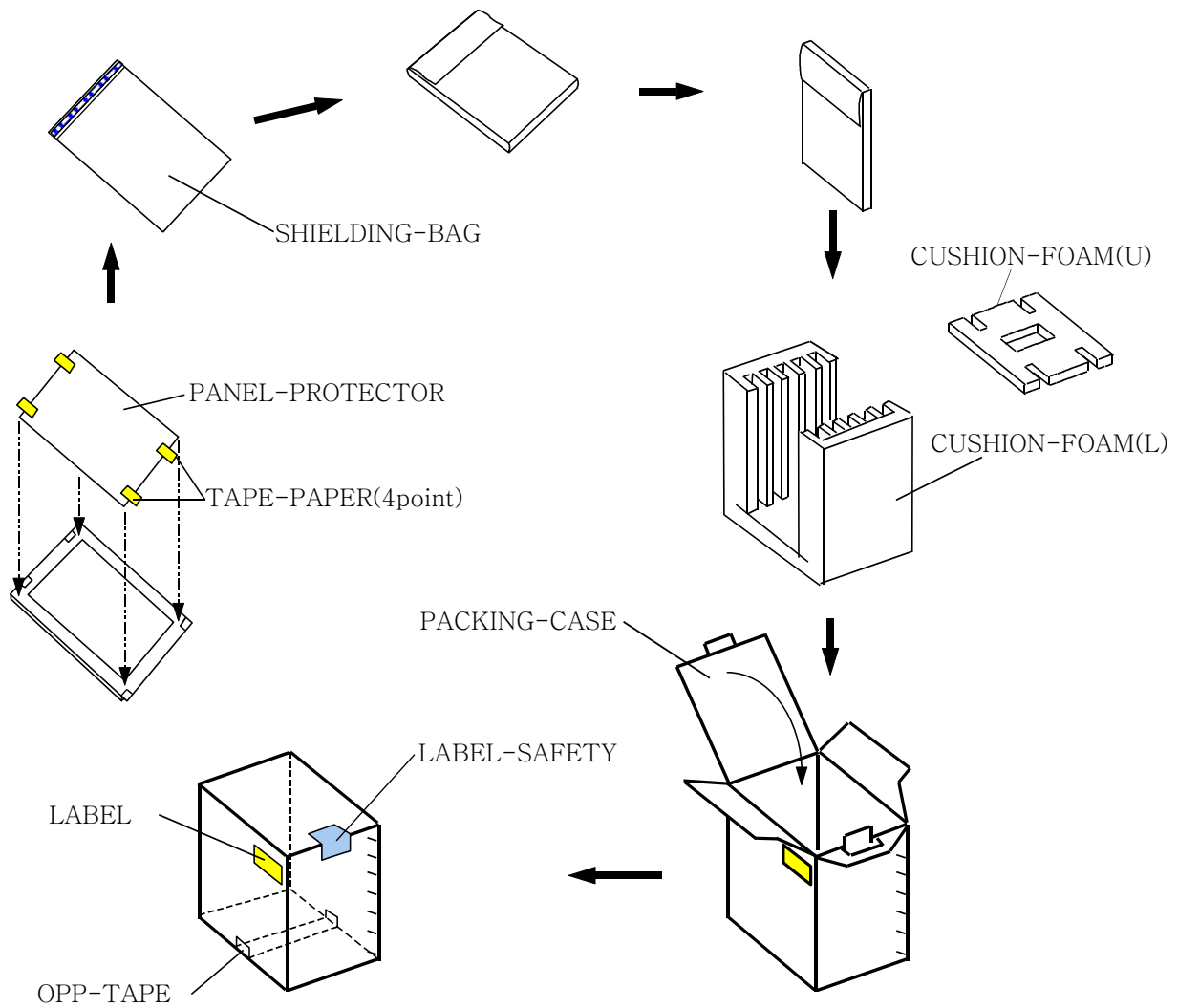

- NOTE 1) Acceptance number of piling : 5sets
2) Carton size :401(W) X 365(D) X 477(H)
3) MAX accumulation quantity : 5 cartons

8.2.1.3 Packing Material

No	Part name	Quality
1	Static electric protective sack	5
2	Packing case(Inner box) included shock absorber	1 set
3	Pictorial marking	2 pcs
4	Carton	1 set

9. GENERAL PRECAUTION

9.1 Handling

- ☞ When the module is assembled, It should be attached to the system firmly using every mounting holes. Be careful not to twist and bend the modules.
- ☞ Refrain from strong mechanical shock and / or any force to the module. In addition to damage, this may cause improper operation or damage to the module and CCFT back-light.
- ☞ Note that polarizers are very fragile and could be easily damaged. Do not press or scratch the surface harder than a HB pencil lead.
- ☞ Wipe off water droplets or oil immediately. If you leave the droplets for a long time, Staining and discoloration may occur.
- ☞ If the surface of the polarizer is dirty, clean it using some absorbent cotton or soft cloth.
- ☞ The desirable cleaners are water, IPA(Isopropyl Alcohol) or Hexane. Do not use Ketone type materials (ex. Acetone), Ethyl alcohol, Toluene, Ethyl acid or Methyl chloride. It might permanent damage to the polarizer due to chemical reaction.
- ☞ If the liquid crystal material leaks from the panel, it should be kept away from the eyes or mouth . In case of contact with hands, legs or clothes, it must be washed away thoroughly with soap.
- ☞ Protect the module from static , it may cause damage to the CMOS IC.
- ☞ Use finger-stalls with soft gloves in order to keep display clean during the incoming inspection and assembly process.
- ☞ Do not disassemble the module.
- ☞ Do not pull or fold the lamp wire.
- ☞ Do not adjust the variable resistor which is located on the back side.
- ☞ Pins of I/F connector shall not be touched directly with bare hands.

9.2 Storage

- ☞ Do not leave the module in high temperature, and high humidity for a long time.
- ☞ It is highly recommended to store the module with temperature from 0°C to 35°C and relative humidity of less than 70%.
- ☞ Do not store the TFT-LCD module in direct sunlight.
- ☞ The module shall be stored in a dark place. It is prohibited to apply sunlight or fluorescent light during the store.

9.3 Operation

- ☞ Do not connect,disconnect the module in the Power On condition.
- ☞ Module has high frequency circuits. Sufficient suppression to the electromagnetic interference shall be done by system manufacturers. Grounding and shielding methods may be important to minimize the interference.

9.4 Others

- ☞ Ultra-violet ray filter is necessary for outdoor operation.
- ☞ Avoid condensation of water. It may result in improper operation or disconnection of electrode.
- ☞ Do not exceed the absolute maximum rating value. (the supply voltage variation, input voltage variation, variation in part contents and environmental temperature, so on) Otherwise the module may be damaged.
- ☞ If the module displays the same pattern continuously for a long period of time, it can be the situation when the image sticks to the screen.
- ☞ This module has its circuitry PCB on the rear side and should be handled carefully in order not to be stressed.