



## PRECISION VOLTAGE REGULATOR

### ■ GENERAL DESCRIPTION

The NJM723 is a Precision Monolithic Voltage Regulator. The device consists of a temperature-compensated Voltage reference, error amplifier, power-series pass transistor and current-limit circuitry. Additional NPN or PNP pass elements may be used when output currents exceeding 150mA are required. In addition to the above, the device features low standby current drain, low temperature drift and high ripple rejection. The NJM723 is intended for use with positive or negative supplies as a series, shunt, switching of floating instrument power supplies, and other power supplies for digital and linear circuits.

### ■ PACKAGE OUTLINE

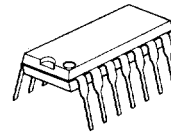

NJM723D

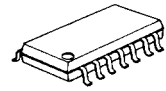

NJM723M



NJM723V

### ■ FEATURES

- Operating Voltage (12V~40V)
- 150mA output current without external pass transistor
- Output currents in excess of 10A possible by adding external
- Input voltage 40V max
- Output voltage adjustable from 2V to 37V
- Can be used as either a linear or a switching regulator.
- Package Outline DIP14, DMP14, SSOP14
- Bipolar Technology

### ■ PIN CONFIGURATION

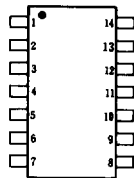

NJM723D  
NJM723M  
NJM723V

1	NC	8	NC
2	Current Limit	9	V <sub>Z</sub>
3	Current Sense	10	V <sub>out</sub>
4	- Input	11	V <sub>c</sub>
5	+ Input	12	V <sup>+</sup>
6	V <sub>REF</sub>	13	COMP
7	V <sup>-</sup>	14	NC

6

### ■ EQUIVALENT CIRCUIT

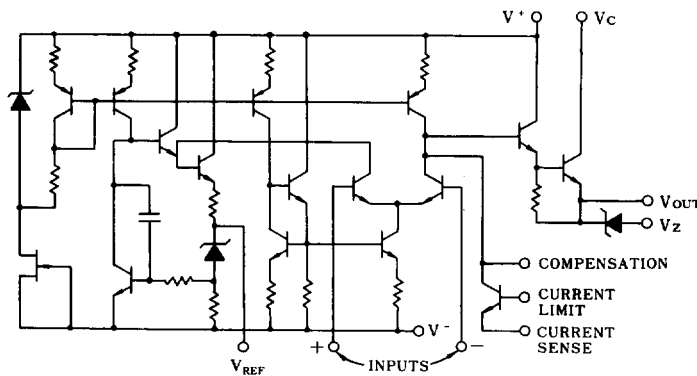



■ ABSOLUTE MAXIMUM RATINGS

(Ta=25°C)

PARAMETER	SYMBOL	RATINGS	UNIT
Supply Voltage	V <sup>+</sup> /V <sup>-</sup>	40	V
Dropout Voltage	ΔV <sub>IO</sub>	40	V
Differential Input Voltage	V <sub>IN</sub> (diff)	±5	V
Output Current	I <sub>O</sub>	150	mA
Power Dissipation	P <sub>D</sub>	(DIP8) 700 (note)	mW
		(DMP8) 700	mW
		(SSOP8) 300	mW
Current from V <sub>REF</sub>	I <sub>REF</sub> (V <sub>REF</sub> )	15	mA
Operating Temperature Range	T <sub>opr</sub>	-20~+75	°C
Storage Temperature Range	T <sub>stg</sub>	-40~+125	°C

(note) At on PC board

■ ELECTRICAL CHARACTERISTICS

(Ta=25°C, V<sup>+</sup>=V<sub>C</sub>=12V, V<sup>-</sup>=0V, V<sub>O</sub>=5V, R<sub>SC</sub>=0, C<sub>I</sub>=100pF, C<sub>REF</sub>=0, I<sub>L</sub>=1mA)

PARAMETER	SYMBOL	TEST CONDITION	MIN.	TYP.	MAX.	UNIT
Line Regulation	ΔV <sub>O</sub> -V <sub>IN</sub>	V <sub>IN</sub> =12~15V V <sub>IN</sub> =12~40V	—	0.01 0.1	0.1 0.5	%V <sub>OUT</sub> %V <sub>OUT</sub>
Load Regulation	ΔV <sub>O</sub> -I <sub>O</sub>	I <sub>O</sub> =1~50mA	—	0.03	0.2	%V <sub>OUT</sub>
Ripple Rejection	RR	f=50~10kHz, C <sub>REF</sub> =0	—	74	—	dB
		f=50~10kHz, C <sub>REF</sub> =5μF	—	86	—	dB
Average Temperature Coefficient of Output Voltage	ΔV <sub>O</sub> /ΔT	-20≤Ta≤75°C	—	0.003	0.018	%/°C
Short Circuit Current Limit	I <sub>CL</sub>	R <sub>sc</sub> =10Ω, V <sub>OUT</sub> =0	—	65	—	mA
Reference Voltage	V <sub>REF</sub>		6.8	7.15	7.5	V
Output Noise Voltage	V <sub>NO</sub>	BW=100Hz~10kHz, C <sub>RF</sub> =0	—	100	—	μV <sub>rms</sub>
		BW=100Hz~10kHz, C <sub>RF</sub> =5μF	—	2.5	—	μV <sub>rms</sub>
Dropout Voltage	V <sub>IO</sub>		3.0	—	38	V
Standby Current Drain	I <sub>STDBY</sub>	I <sub>L</sub> =0, V <sub>IN</sub> =30V, V <sub>O</sub> =V <sub>REF</sub>	—	2.3	4.0	mA
Input Voltage Range	V <sub>IN</sub>		9.5	—	40	V
Output Voltage Range	V <sub>O</sub>		2.0	—	37	V



## ■ TYPICAL APPLICATION

**Maximum Load Current vs. Input Output Voltage Differential**

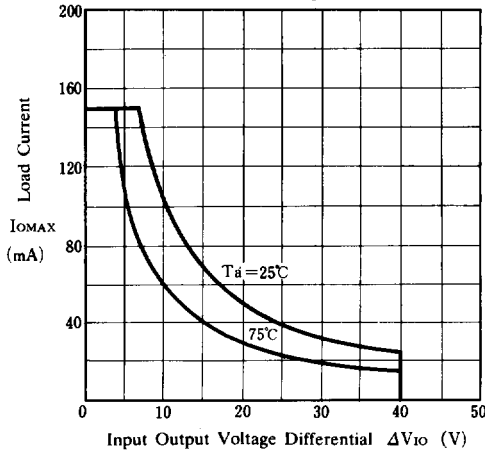

**Load Regulation vs. Output Current**  
( $V_0 = +5V$ ,  $V^+ = +12V$ ,  $R_{SC} = 10\Omega$ )

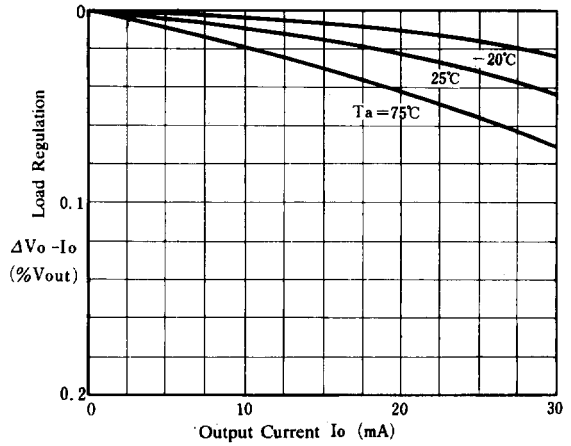

**Relative Output Voltage vs. Output Current**

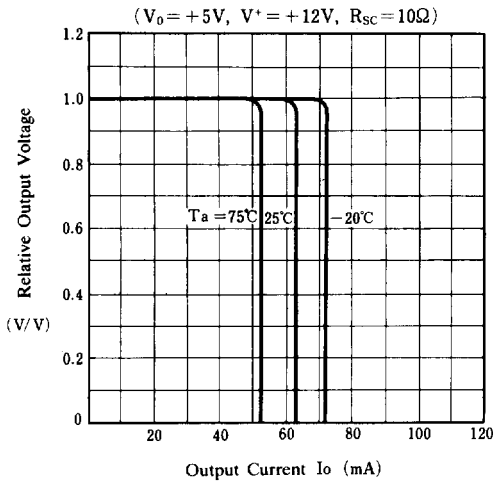

**Standby Current vs. Input Voltage**

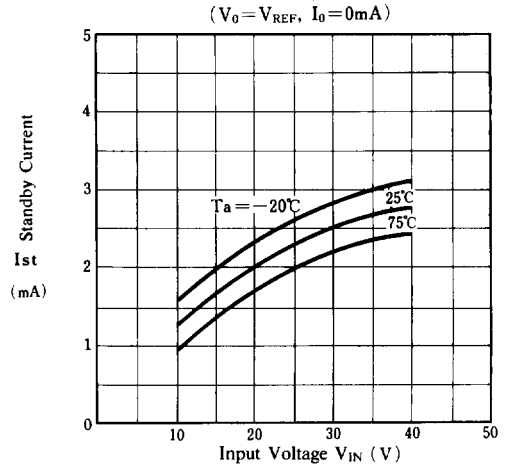

## ■ TYPICAL CHARACTERISTICS

