

International
IR Rectifier

SD200N/R SERIES

STANDARD RECOVERY DIODES

Stud Version

Features

- Wide current range
- High voltage ratings up to 2400V
- High surge current capabilities
- Stud cathode and stud anode version
- Standard JEDEC types

200A

Typical Applications

- Converters
- Power supplies
- Machine tool controls
- High power drives
- Medium traction applications

Major Ratings and Characteristics

Parameters	SD200N/R		Units	
	400 to 2000	2400		
$I_{F(AV)}$	200	200	A	
@ T_C	110	110	°C	
$I_{F(RMS)}$	314	314	A	
I_{FSM}	@50Hz	4700	4700	A
	@60Hz	4920	4920	A
I^2t	@50Hz	110	110	KA ² s
	@60Hz	101	101	KA ² s
V_{RRM} range	400 to 2000	2400	V	
T_J	- 40 to 180	150	°C	

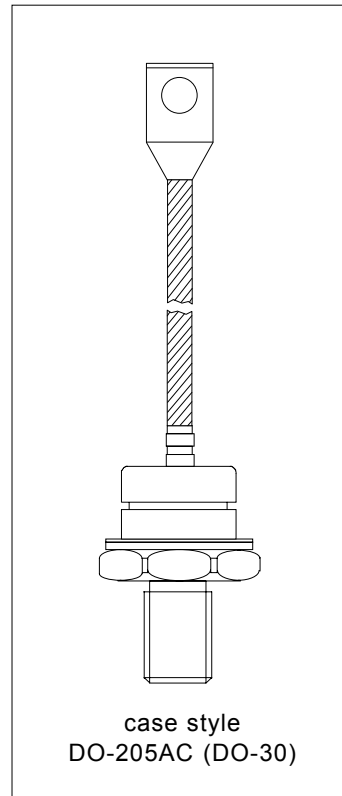

SD200N/R Series

Bulletin I2080 rev. B 11/01

International

ELECTRICAL SPECIFICATIONS

Voltage Ratings

Type number	Voltage Code	V_{RRM} , maximum repetitive peak reverse voltage V	V_{RSM} , maximum non-repetitive peak rev. voltage V	I_{RRM} max. @ $T_J = T_J$ max. mA
SD200N/R	04	400	500	15
	08	800	900	
	12	1200	1300	
	16	1600	1700	
	20	2000	2100	
	24	2400	2500	

Forward Conduction

Parameter	SD200N/R	Units	Conditions
$I_{F(AV)}$ Max. average forward current @ Case temperature	200	A	180° conduction, half sine wave
	110	°C	
$I_{F(AV)}$ Max. average forward current @ Case temperature	220	A	180° conduction, half sine wave
	100	°C	
$I_{F(RMS)}$ Max. RMS forward current	314	A	DC @ 95°C case temperature
I_{FSM} Max. peak, one-cycle forward, non-repetitive surge current	4700	A	t = 10ms No voltage
	4920		t = 8.3ms reapplied
	3950		t = 10ms 100% V_{RRM}
	4140		t = 8.3ms reapplied
I^2t Maximum I^2t for fusing	110	KA ² s	t = 10ms No voltage
	101		t = 8.3ms reapplied
	78		t = 10ms 100% V_{RRM}
	71		t = 8.3ms reapplied
$I^2\sqrt{t}$ Maximum $I^2\sqrt{t}$ for fusing	1100	KA ² /√s	t = 0.1 to 10ms, no voltage reapplied
$V_{F(TO)1}$ Low level value of threshold voltage	0.90	V	$(16.7\% \times \pi \times I_{F(AV)} < I < \pi \times I_{F(AV)})$, $T_J = T_J$ max.
$V_{F(TO)2}$ High level value of threshold voltage	1.00		$(I > \pi \times I_{F(AV)})$, $T_J = T_J$ max.
r_{f1} Low level value of forward slope resistance	0.79	mΩ	$(16.7\% \times \pi \times I_{F(AV)} < I < \pi \times I_{F(AV)})$, $T_J = T_J$ max.
r_{f2} High level value of forward slope resistance	0.64		$(I > \pi \times I_{F(AV)})$, $T_J = T_J$ max.
V_{FM} Max. forward voltage drop	1.40	V	$I_{pk} = 630A$, $T_J = T_J$ max, $t_p = 10ms$ sinusoidal wave

Thermal and Mechanical Specifications

Parameter	SD200N/R		Units	Conditions
	400to2000	2400		
T _J Max. junction operating temperature range	-40 to 180	150	°C	
T _{stg} Max. storage temperature range	-55 to 200			
R _{thJC} Max. thermal resistance, junction to case	0.23		K/W	DC operation Mounting surface, smooth, flat and greased
R _{thCS} Max. thermal resistance, case to heatsink	0.08			
T Max. allowed mounting torque ±10%	14		Nm	Not lubricated threads
wt Approximate weight	120		g	
Case style	DO-205AC(DO-30)		See Outline Table	

ΔR_{thJC} Conduction

(The following table shows the increment of thermal resistance R_{thJC} when devices operate at different conduction angles than DC)

Conduction angle	Sinusoidal conduction	Rectangular conduction	Units	Conditions
180°	0.041	0.030	K/W	T _J = T _J max.
120°	0.049	0.051		
90°	0.063	0.068		
60°	0.093	0.096		
30°	0.156	0.157		

Ordering Information Table

Device Code

SD	20	0	N	24	P	B	C
1	2	3	4	5	6	7	8

- 1** - Diode
- 2** - Essential part number
- 3** - 0 = Standard recovery
- 4** - N = Stud Normal Polarity (Cathode to Stud)
R = Stud Reverse Polarity (Anode to Stud)
- 5** - Voltage code: Code x 100 = V_{RRM} (See Voltage Ratings table)
- 6** - P = Stud base DO-205AC (DO-30) 1/2" 20UNF-2A
M = Stud base DO-205AC (DO-30) M12 X 1.75
- 7** - B = Flag top terminal (for Cathode/ Anode Leads)
S = Isolated lead with silicone sleeve
(Red = Reverse Polarity; Blue = Normal Polarity)
None = Non isolated lead
- 8** - C = Ceramic Housing (over 1600V)
V = Glass-metal seal (only up to 1600V)

SD200N/R Series

Bulletin I2080 rev. B 11/01

Outline Table

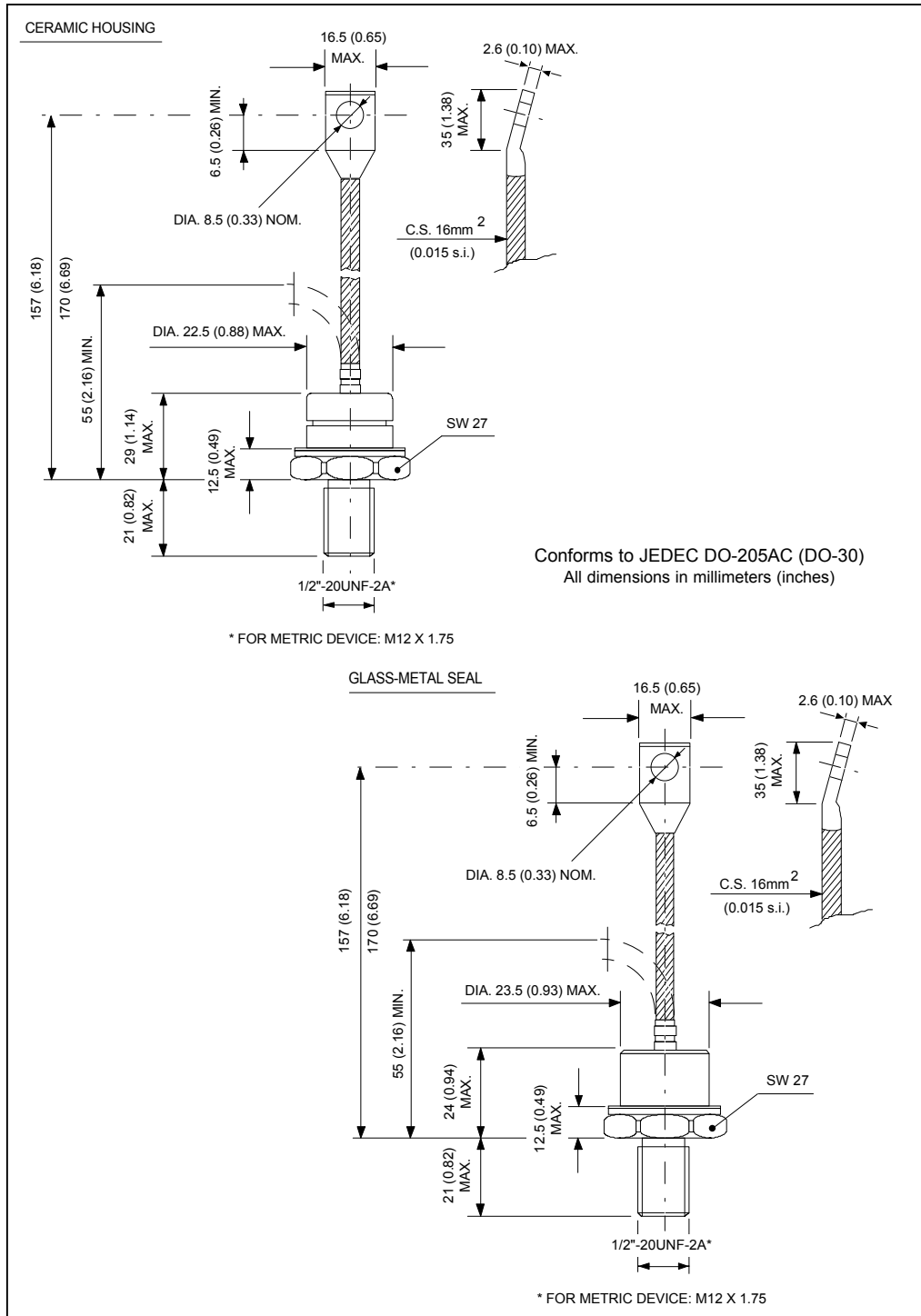

Outline Table

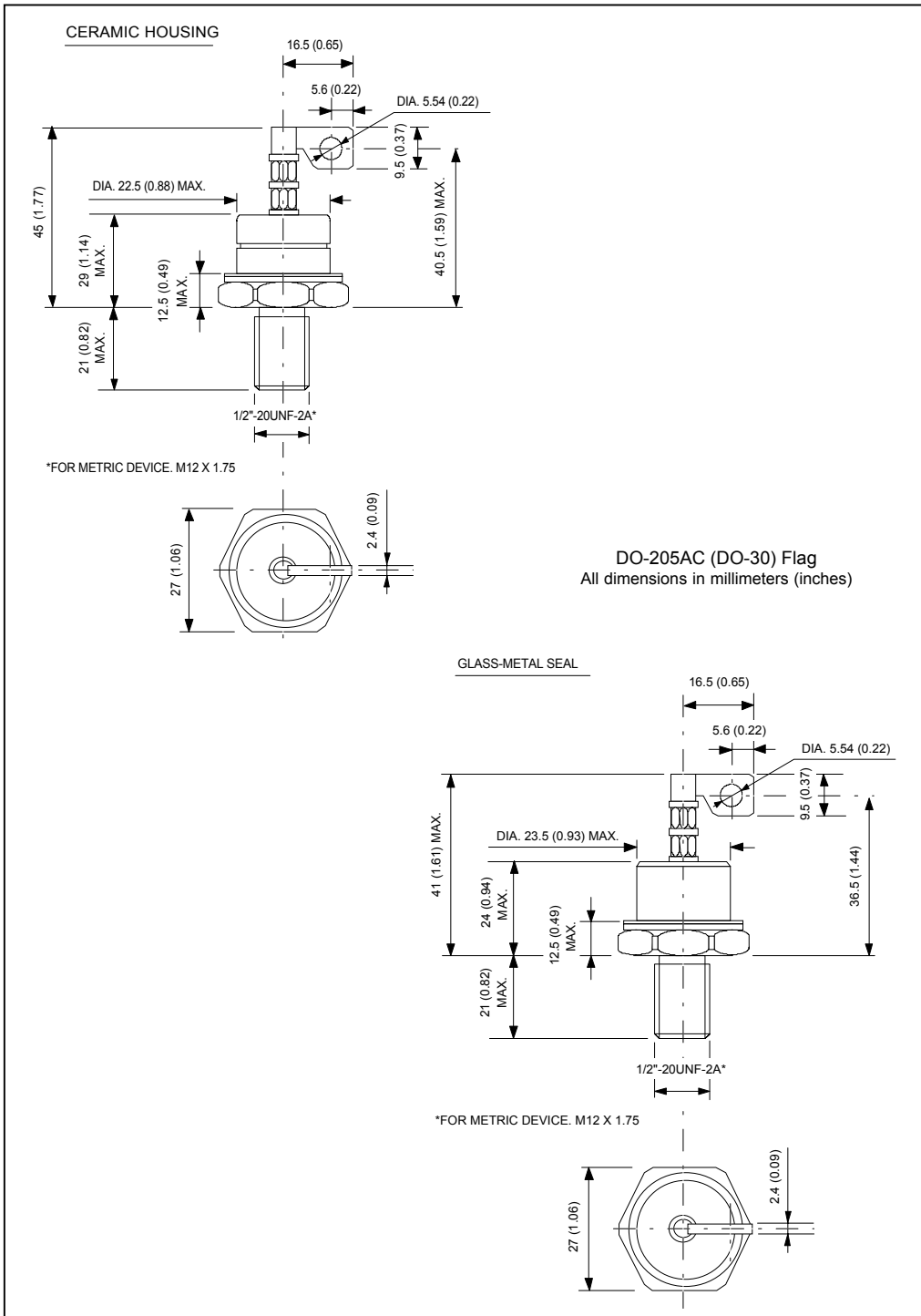

SD200N/R Series

Bulletin I2080 rev. B 11/01

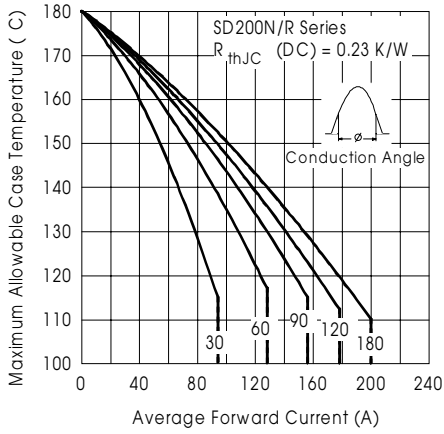

Fig. 1 - Current Ratings Characteristics

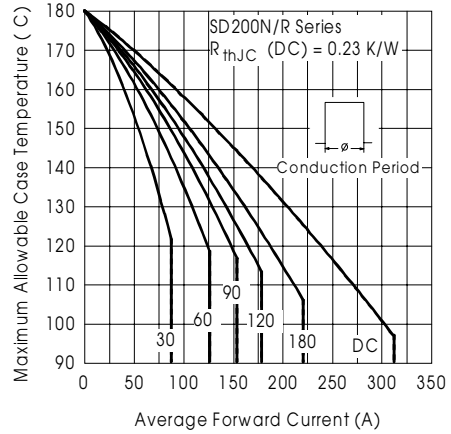

Fig. 2 - Current Ratings Characteristics

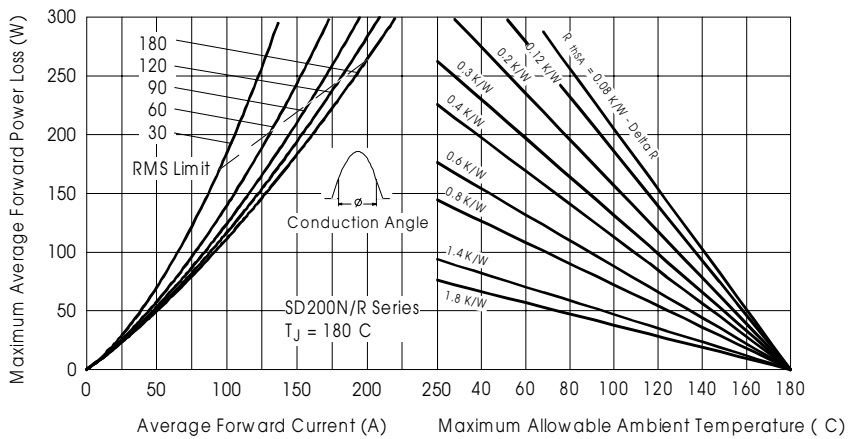

Fig. 3 - Forward Power Loss Characteristics

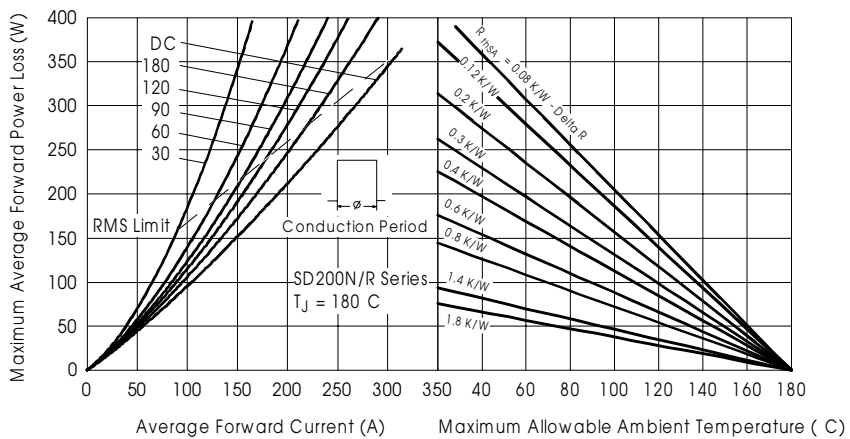

Fig. 4 - Forward Power Loss Characteristics

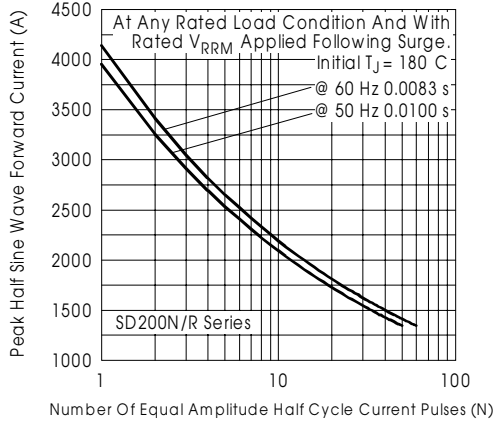

Fig. 5 - Maximum Non-Repetitive Surge Current

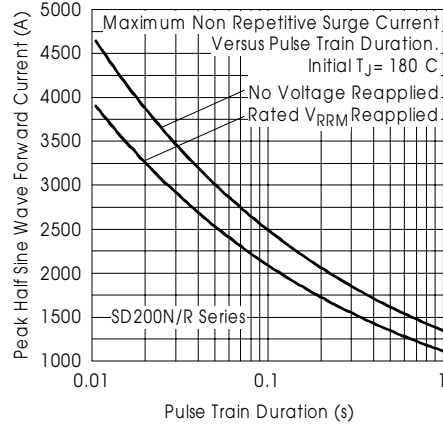

Fig. 6 - Maximum Non-Repetitive Surge Current

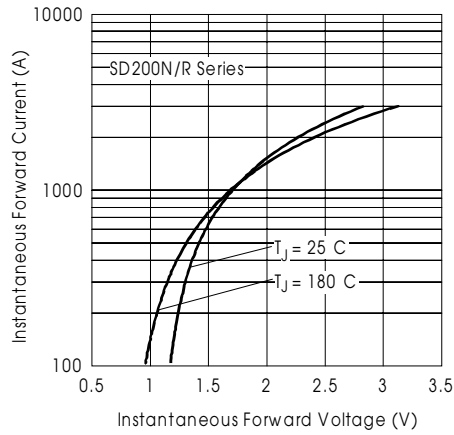

Fig. 7 - Forward Voltage Drop Characteristics

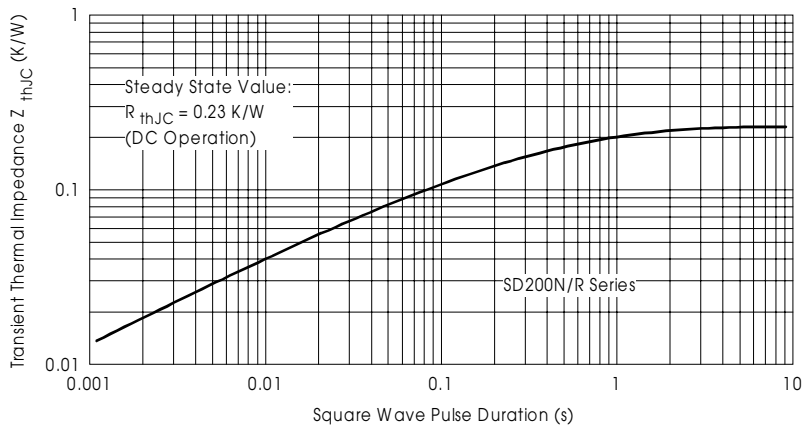

Fig. 8 - Thermal Impedance Z_{thJC} Characteristic

SD200N/R Series

Bulletin I2080 rev. B 11/01

International
IOR Rectifier

Data and specifications subject to change without notice.
This product has been designed and qualified for Industrial Level.
Qualification Standards can be found on IR's Web site.

International
IOR Rectifier

IR WORLD HEADQUARTERS: 233 Kansas St., El Segundo, California 90245, USA Tel: (310) 252-7105
TAC Fax: (310) 252-7309
Visit us at www.irf.com for sales contact information. 11/01