



■ Features

- (1) High attenuation effect against high voltage pulse noise by amorphous core.
- (2) Block terminal with cover
Simple wire connection
High safety by cover.

■ Safety standard

UL1283, CSA Std. C22. 2 No. 8
VDE0565 Teil. 3, Teil 3A2
(VDE0565 will transfer to EN133200)
on and after July 23, 2003.

■ Specifications

Item	Model	MYB-1206-33	MYB-1210-33	MYB-1220-33	MYB-1230-33
1	Rated voltage (AC, DC)	250V			
2	Rated current (AC, DC) (Note)	6A	10A	20A	30A
3	Test voltage (terminal to case, AC 1 minute)	2500V (25°C, 70% RH)			
4	Isolation resistance (terminal to case, 500VDC)	100MΩ min. (25°C, 70% RH)			
5	Leakage current	125V, 60Hz		0.25mA max.	
		250V, 60Hz		0.5mA max.	
6	DC resistance	0.1Ω max.	0.05Ω max.	0.02Ω max.	0.01Ω max.
7	Temperature rise	30°C max.			
8	Operating temperature	-25 ~ +85°C			
9	Operating humidity	30% ~ 90% RH (No dewdrop)			
10	Storage temperature	-30 ~ +85°C			
11	Storage humidity	10% ~ 95% RH (No dewdrop)			
12	Vibration	Sweep: 10 ~ 55 ~ 10Hz (for 1 minute), Amplitude: 1.5mm X, Y and Z axes for 2 hours			
13	Safety standard	Approved by UL1283, CSA C22.2 No. 8 (C-UL) and VDE0565 Teil3, Teil3A2			
14	Weight (typ)	210g	260g	450g	510g

(Note) : Value at Ta ≤ 50°C. Refer to the derating curve shown below at Ta > 50°C.

■ Circuit

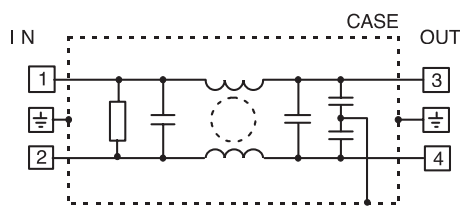

■ Derating

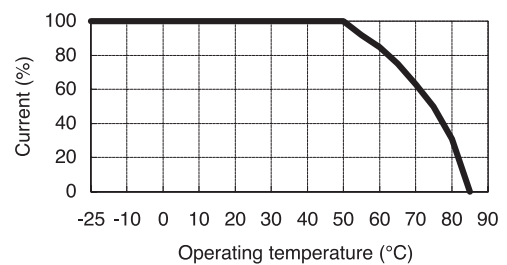

● Request customer specification for further details of specifications, outline, characteristics, etc.
Read the instruction manual before usage.
● Contact us about delivery before ordering.

MYB-SERIES

MYB-1206-33

MYB-1210-33

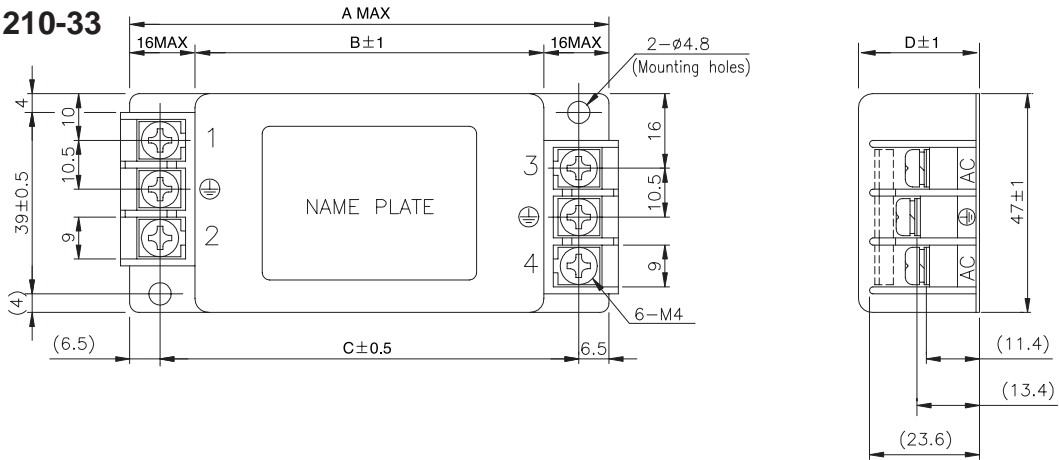

Models	A	B	C	D
MYB-1206-33	108	75	90	26
MYB-1210-33	118	85	100	30

MYB-1220-33

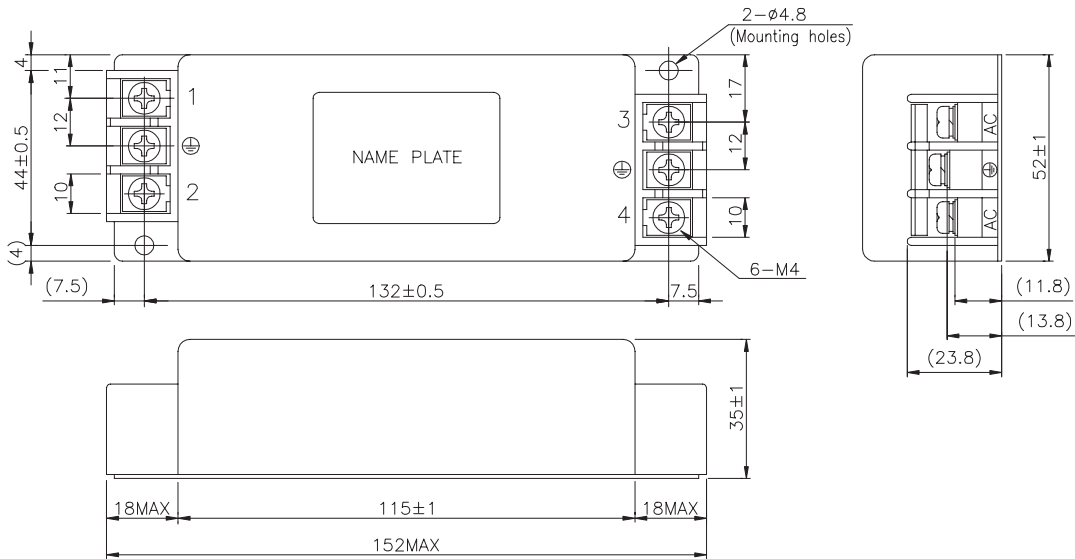

MYB-1230-33

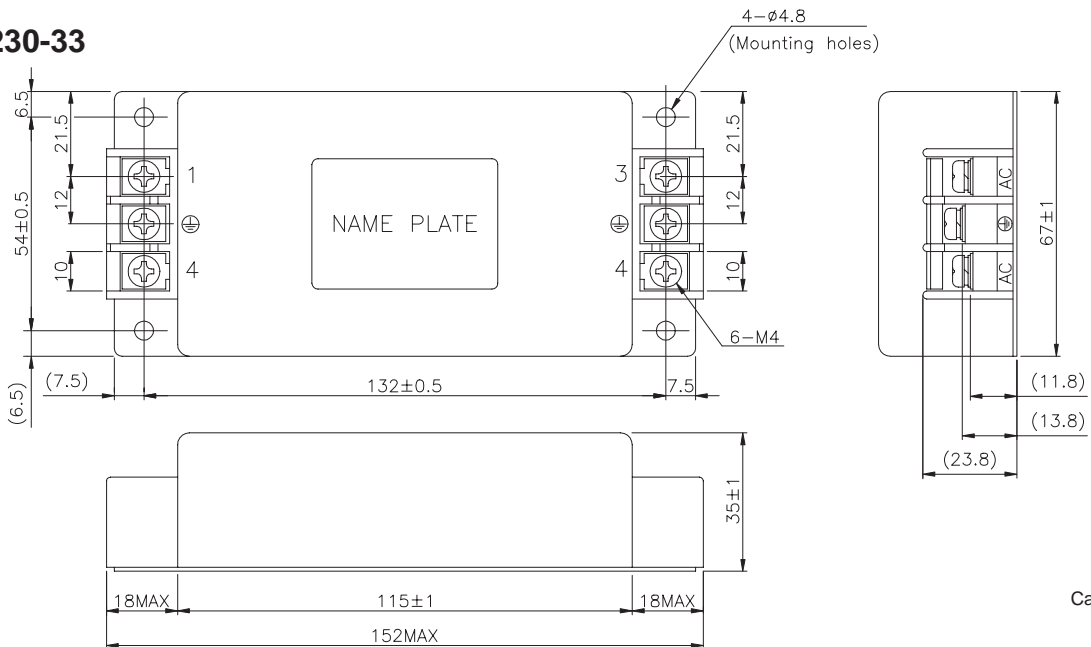

Case: Metal

(Unit: mm)

Noise Filter

CHARACTERISTICS

■ Typical Insertion Loss

MYB-1206-33

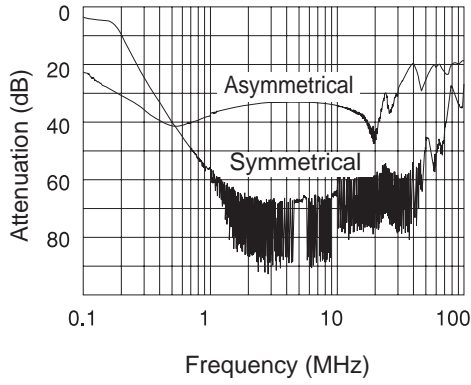

MYB-1210-33

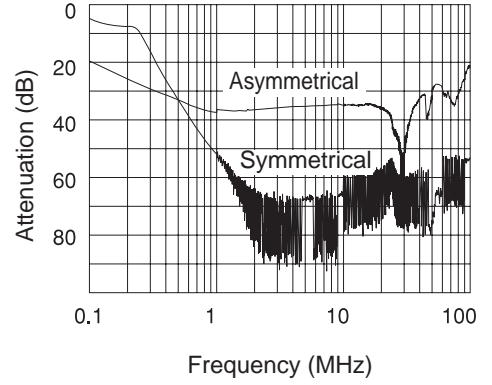

MYB-1220-33

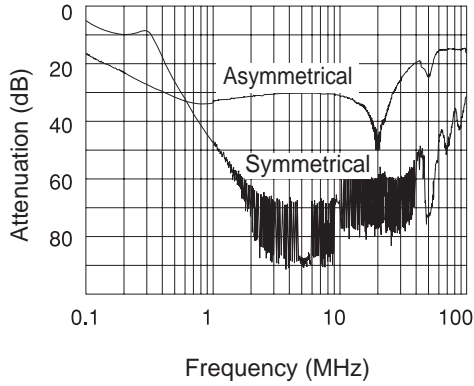

MYB-1230-33

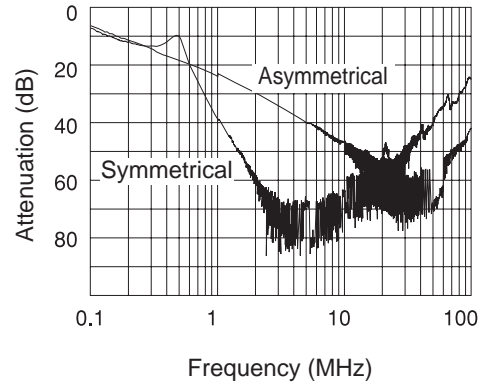

MYB (50/70/90A)-SERIES

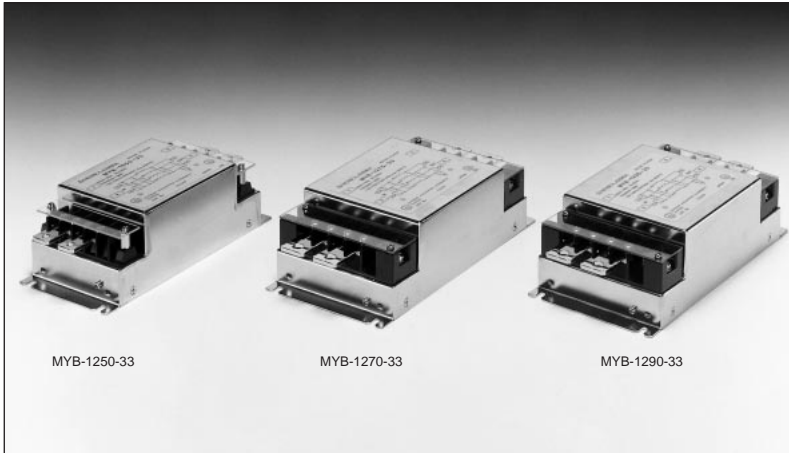

■ Features

- (1) High attenuation effect against high voltage pulse noise
- (2) Compact and low profile (H = 65mm)
- (3) Leakage current: 1mA max. (250V, 60Hz)

■ Safety standard

- (1) MYB-1250-33, MYB-1290-33
Conforms to UL safety standard (UL1283)
Conforms to CSA safety standard (CSA Std. C22. 2 No. 8)
- (2) MYB-1270-33
 UL1283, CSA Std. C22. 2 No. 8

■ Specifications

Item	Model	MYB-1250-33	MYB-1270-33	MYB-1290-33
1	Rated voltage (AC, DC)	250V		
2	Rated current (AC, DC) (Note)	50A	70A	90A
3	Test voltage (terminal to case, AC 1 minute)	2500V (25°C, 70% RH)		
4	Isolation resistance (terminal to case, 500VDC)	300MΩ min. (25°C, 70% RH)		
5	Leakage current	125V, 60Hz	0.5mA max.	
		250V, 60Hz	0.1mA max.	
6	DC resistance	2.5mΩ max.	1.9mΩ max.	1.3mΩ max.
7	Temperature rise	35°C max		
8	Operating temperature	-25 ~ +85°C		
9	Operating humidity	30% ~ 90% RH (No dewdrop)		
10	Storage temperature	-30 ~ +85°C		
11	Storage humidity	10% ~ 95% RH (No dewdrop)		
12	Vibration	Sweep: 10 ~ 55 ~ 10Hz (for 1 minute), Amplitude: 1.5mm X, Y and Z axes for 2 hours		
13	Safety standard	Only MYB-1270-33 is approved by UL 1283 and CSA std. C22. 2 No. 8		
14	Weight (typ)	2000g	2900g	3000g

(Note) : Value at Ta ≦50°C. Refer to the derating curve shown below at Ta > 50°C.

■ Circuit

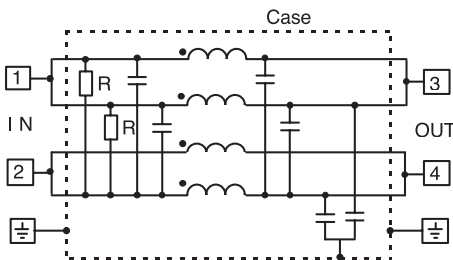

■ Derating

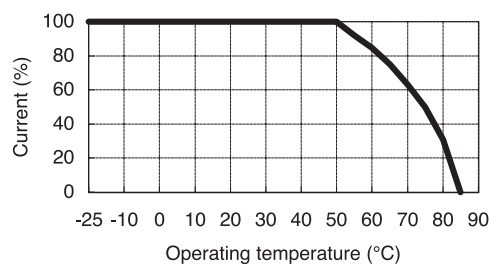

● Request customer specification for further details of specifications, outline, characteristics, etc.
Read the instruction manual before usage.
● Contact us about delivery before ordering.

MYB (50/70/90A)-SERIES

MYB-1250-33

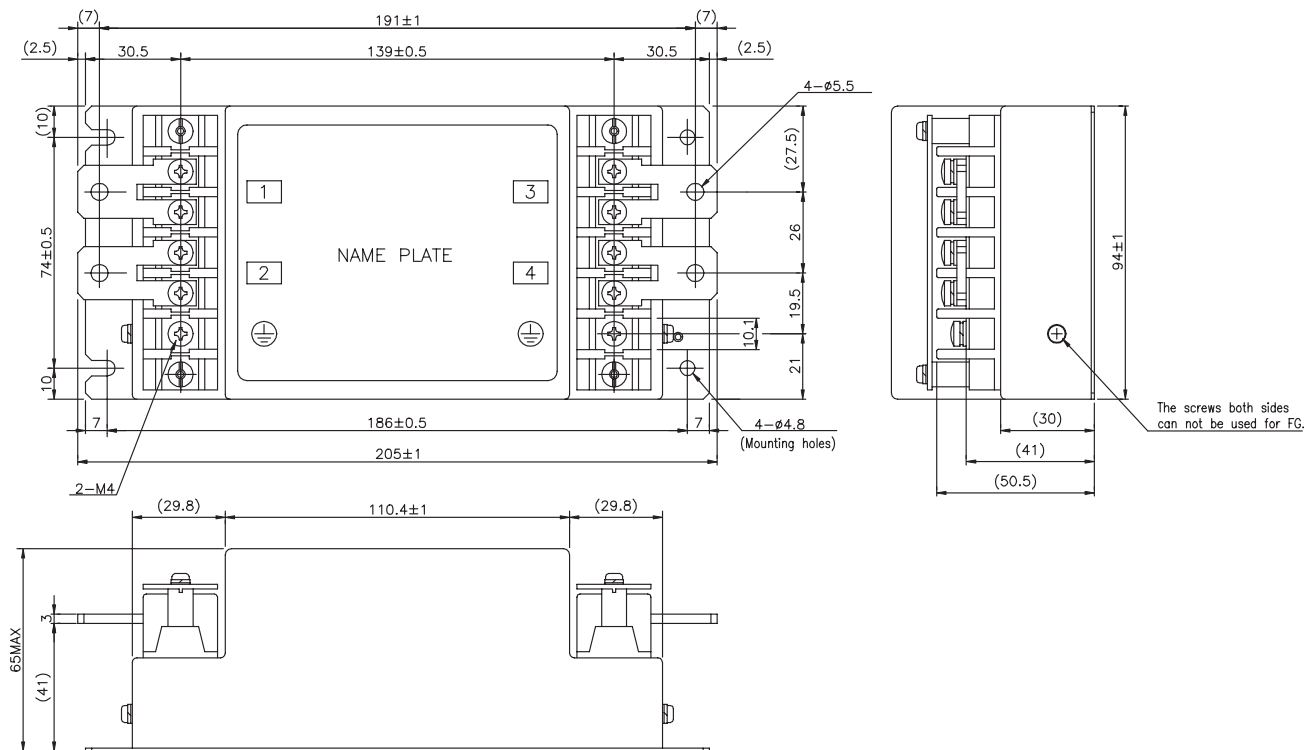

MYB-1270-33

MYB-1290-33

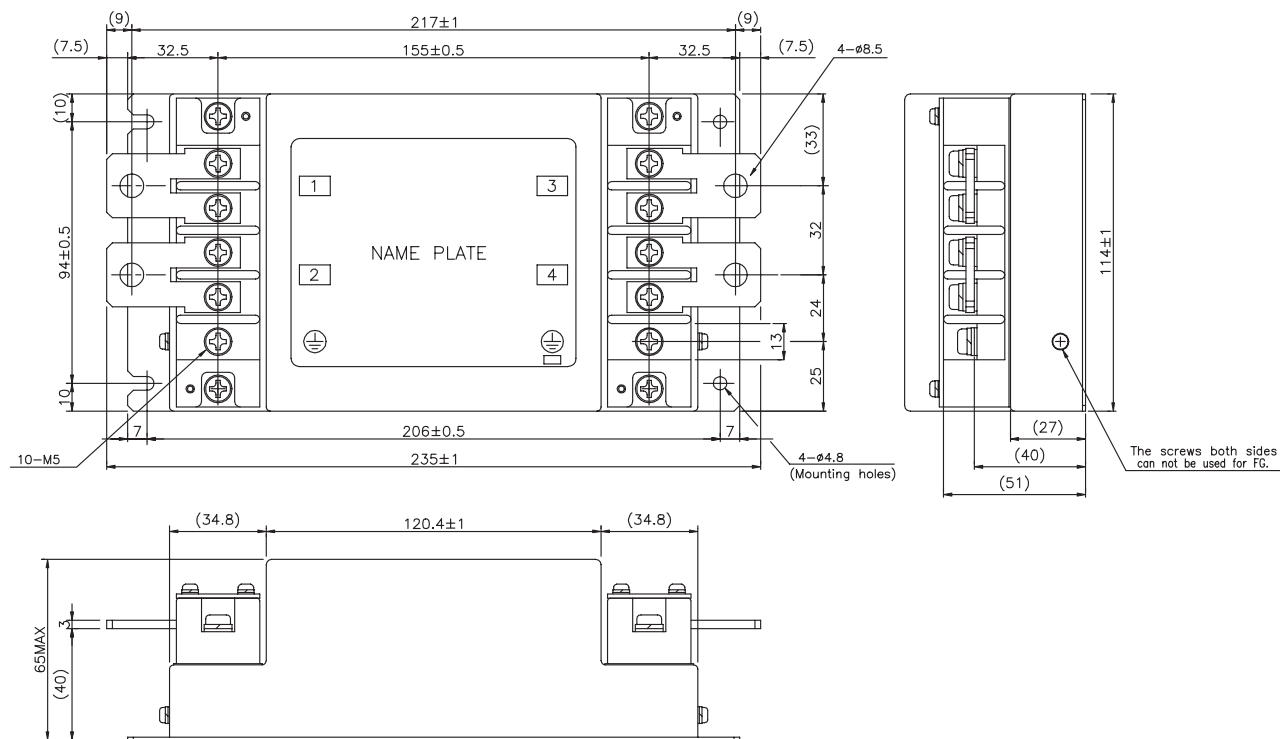

Case: Metal

(Unit: mm)

CHARACTERISTICS

■ Typical Insertion Loss

MYB-1250-33

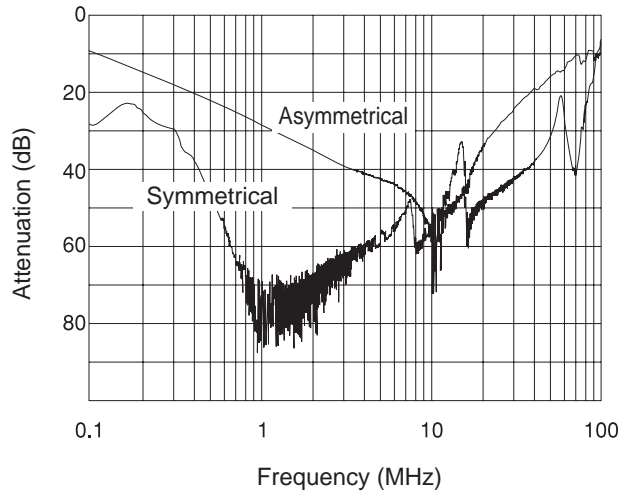

MYB-1270-33

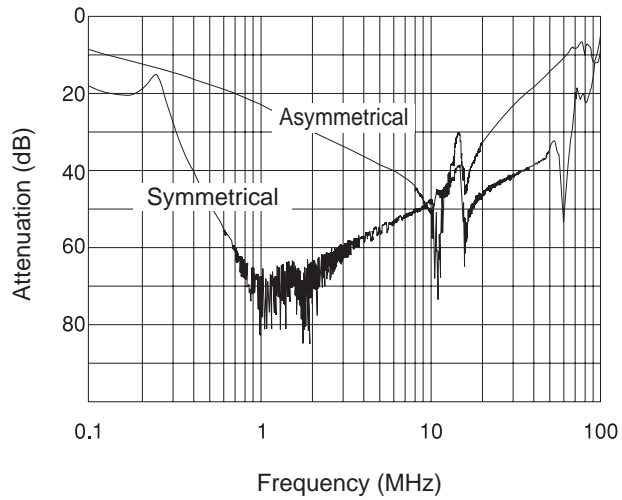

MYB-1290-33

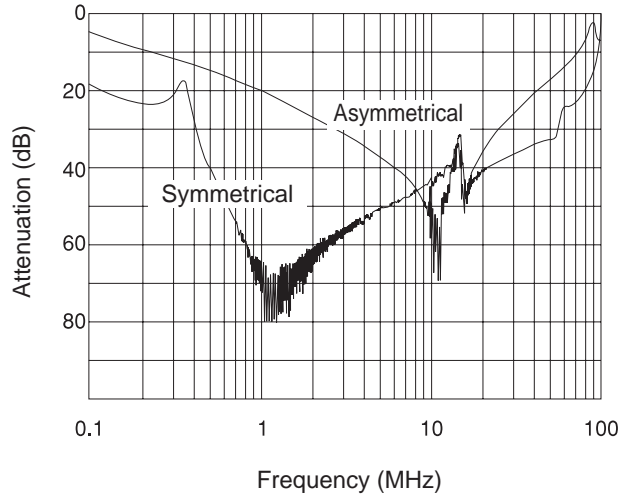

Noise Filter