



## 3.3V ZERO DELAY CLOCK BUFFER

**IDT2309**

### FEATURES:

- Phase-Lock Loop Clock Distribution
- 10MHz to 133MHz operating frequency
- Distributes one clock input to one bank of five and one bank of four outputs
- Separate output enable for each output bank
- Output Skew < 250ps
- Low jitter < 200 ps cycle-to-cycle
- IDT2309-1 for Standard Drive
- IDT2309-1H for High Drive
- No external RC network required
- Operates at 3.3V V<sub>DD</sub>
- Available in SOIC and TSSOP packages

### DESCRIPTION:

The IDT2309 is a high-speed phase-lock loop (PLL) clock buffer, designed to address high-speed clock distribution applications. The zero delay is achieved by aligning the phase between the incoming clock and the output clock, operable within the range of 10 to 133MHz.

The IDT2309 is a 16-pin version of the IDT2305. The IDT2309 accepts one reference input, and drives two banks of four low skew clocks. The -1H version of this device operates at up to 133MHz frequency and has higher drive than the -1 device. All parts have on-chip PLLs which lock to an input clock on the REF pin. The PLL feedback is on-chip and is obtained from the CLKOUT pad. In the absence of an input clock, the IDT2309 enters power down, and the outputs are tri-stated. In this mode, the device will draw less than 25µA.

The IDT2309 is characterized for both Industrial and Commercial operation.

**NOTE:** For new designs, refer to AN-233.

### FUNCTIONAL BLOCK DIAGRAM

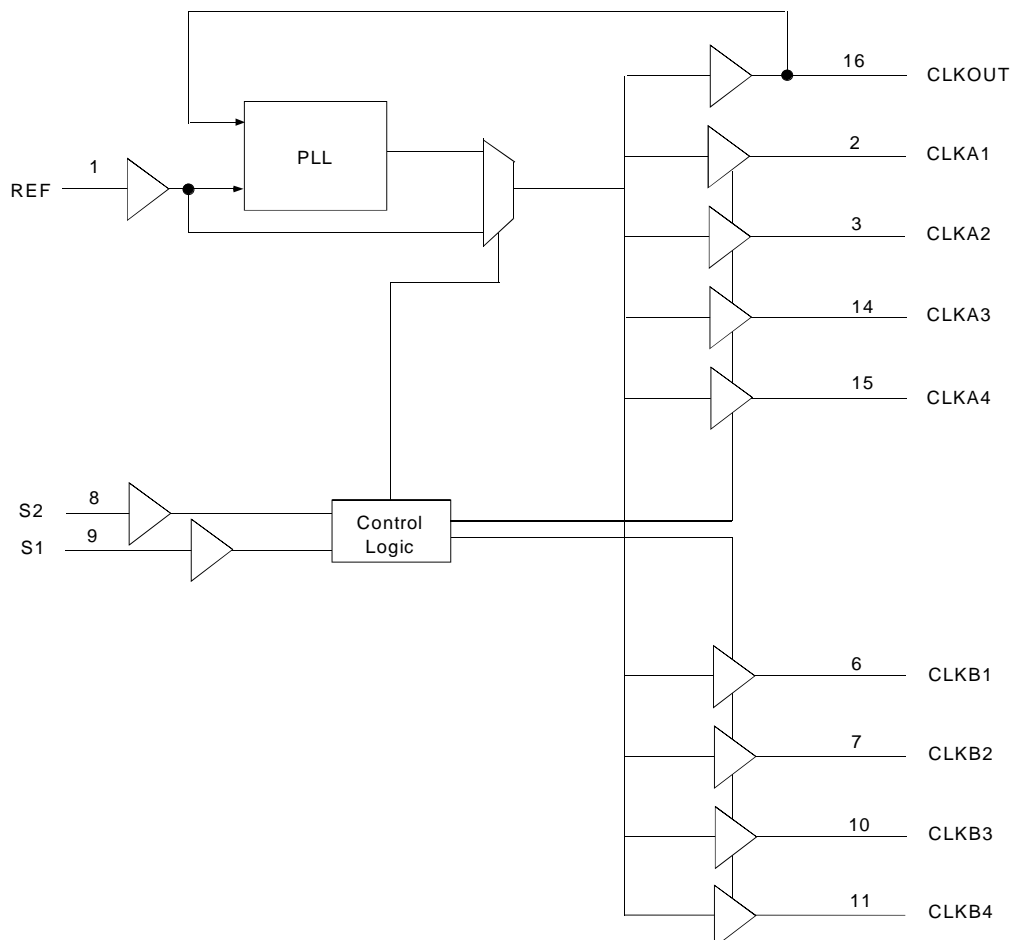

The IDT logo is a registered trademark of Integrated Device Technology, Inc.

COMMERCIAL AND INDUSTRIAL TEMPERATURE RANGES

NOVEMBER 2002

## PIN CONFIGURATION

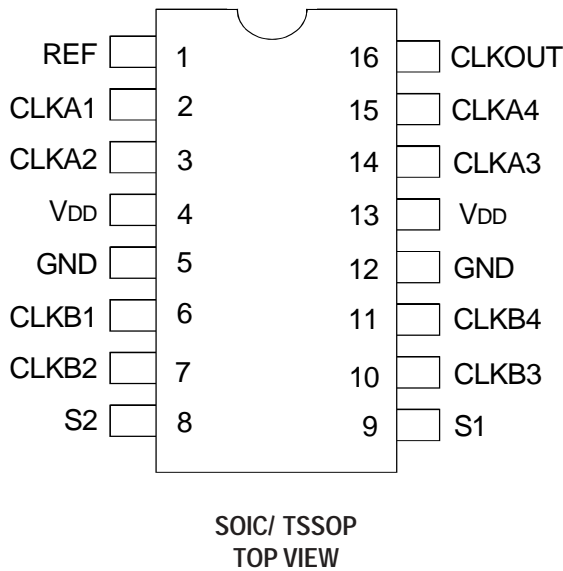

## ABSOLUTE MAXIMUM RATINGS<sup>(1)</sup>

Symbol	Rating	Max.	Unit
V <sub>DD</sub>	Supply Voltage Range	-0.5 to +4.6	V
V <sub>I</sub> <sup>(2)</sup>	Input Voltage Range (REF)	-0.5 to +5.5	V
V <sub>I</sub>	Input Voltage Range (except REF)	-0.5 to V <sub>DD</sub> +0.5	V
I <sub>IK</sub> (V <sub>I</sub> < 0)	Input Clamp Current	-50	mA
I <sub>O</sub> (V <sub>O</sub> = 0 to V <sub>DD</sub> )	Continuous Output Current	±50	mA
V <sub>DD</sub> or GND	Continuous Current	±100	mA
T <sub>A</sub> = 55°C (in still air) <sup>(3)</sup>	Maximum Power Dissipation	0.7	W
T <sub>STG</sub>	Storage Temperature Range	-65 to +150	°C
Operating Temperature	Commercial Temperature Range	0 to +70	°C
Operating Temperature	Industrial Temperature Range	-40 to +85	°C

### NOTES:

- Stresses greater than those listed under ABSOLUTE MAXIMUM RATINGS may cause permanent damage to the device. This is a stress rating only and functional operation of the device at these or any other conditions above those indicated in the operational sections of this specification is not implied. Exposure to absolute maximum rating conditions for extended periods may affect reliability.
- The input and output negative-voltage ratings may be exceeded if the input and output clamp-current ratings are observed.
- The maximum package power dissipation is calculated using a junction temperature of 150°C and a board trace length of 750 mils.

## APPLICATIONS:

- SDRAM
- Telecom
- Datacom
- PC Motherboards/Workstations
- Critical Path Delay Designs

## PIN DESCRIPTION

Pin Name	Pin Number	Type	Functional Description
REF <sup>(1)</sup>	1	IN	Input reference clock, 5 Volt tolerant input
CLKA1 <sup>(2)</sup>	2	Out	Output clock for bank A
CLKA2 <sup>(2)</sup>	3	Out	Output clock for bank A
V <sub>DD</sub>	4, 13	PWR	3.3V Supply
GND	5, 12	GND	Ground
CLKB1 <sup>(2)</sup>	6	Out	Output clock for bank B
CLKB2 <sup>(2)</sup>	7	Out	Output clock for bank B
S2 <sup>(3)</sup>	8	IN	Select input Bit 2
S1 <sup>(3)</sup>	9	IN	Select input Bit 1
CLKB3 <sup>(2)</sup>	10	Out	Output clock for bank B
CLKB4 <sup>(2)</sup>	11	Out	Output clock for bank B
CLKA3 <sup>(2)</sup>	14	Out	Output clock for bank A
CLKA4 <sup>(2)</sup>	15	Out	Output clock for bank A
CLKOUT <sup>(2)</sup>	16	Out	Output clock, internal feedback on this pin

### NOTES:

- Weak pull down.
- Weak pull down on all outputs.
- Weak pull ups on these inputs.

FUNCTION TABLE<sup>(1)</sup>

S2	S1	CLKA	CLKB	CLKOUT <sup>(2)</sup>	Output Source	PLL Shut Down
L	L	Tri-State	Tri-State	Driven	PLL	N
L	H	Driven	Tri-State	Driven	PLL	N
H	L	Driven	Driven	Driven	REF	Y
H	H	Driven	Driven	Driven	PLL	N

NOTES:

- H = HIGH Voltage Level.  
L = LOW Voltage Level
- This output is driven and has an internal feedback for the PLL. The load on this output can be adjusted to change the skew between the REF and the output.

DC ELECTRICAL CHARACTERISTICS - COMMERCIAL

Symbol	Parameter	Conditions		Min.	Max.	Unit
V <sub>IL</sub>	Input LOW Voltage Level			—	0.8	V
V <sub>IH</sub>	Input HIGH Voltage Level			2	—	V
I <sub>IL</sub>	Input LOW Current	V <sub>IN</sub> = 0V		—	50	μA
I <sub>IH</sub>	Input HIGH Current	V <sub>IN</sub> = V <sub>DD</sub>		—	100	μA
V <sub>OL</sub>	Output LOW Voltage	Standard Drive	I <sub>OL</sub> = 8mA	—	0.4	V
		High Drive	I <sub>OL</sub> = 12mA (-1H)			
V <sub>OH</sub>	Output HIGH Voltage	Standard Drive	I <sub>OH</sub> = -8mA	2.4	—	V
		High Drive	I <sub>OH</sub> = -12mA (-1H)			
I <sub>DD_PD</sub>	Power Down Current	REF = 0MHz (S2 = S1 = H)		—	12	μA
I <sub>DD</sub>	Supply Current	Unloaded Outputs at 66.66MHz, SEL inputs at V <sub>DD</sub> or GND		—	32	mA

OPERATING CONDITIONS - COMMERCIAL

Symbol	Parameter	Min.	Max.	Unit
V <sub>DD</sub>	Supply Voltage	3	3.6	V
T <sub>A</sub>	Operating Temperature (Ambient Temperature)	0	70	°C
C <sub>L</sub>	Load Capacitance < 100MHz	—	30	pF
	Load Capacitance 100MHz - 133MHz	—	10	
C <sub>IN</sub>	Input Capacitance	—	7	pF

SWITCHING CHARACTERISTICS (2309-1) - COMMERCIAL<sup>(1,2)</sup>

Symbol	Parameter	Conditions	Min.	Typ.	Max.	Unit
t <sub>f</sub>	Output Frequency	10pF Load	10	—	133	MHz
		30pF Load	10	—	100	
	Duty Cycle = t <sub>2</sub> ÷ t <sub>1</sub>	Measured at 1.4V, F <sub>OUT</sub> = 66.66MHz	40	50	60	%
t <sub>r</sub>	Rise Time	Measured between 0.8V and 2V	—	—	2.5	ns
t <sub>f</sub>	Fall Time	Measured between 0.8V and 2V	—	—	2.5	ns
t <sub>s</sub>	Output to Output Skew	All outputs equally loaded	—	—	250	ps
t <sub>6A</sub>	Delay, REF Rising Edge to CLKOUT Rising Edge <sup>(2)</sup>	Measured at V <sub>DD</sub> /2	—	0	±350	ps
t <sub>6B</sub>	Delay, REF Rising Edge to CLKOUT Rising Edge <sup>(2)</sup>	Measured at V <sub>DD</sub> /2 in PLL bypass mode (IDT2309 only)	1	5	8.7	ns
t <sub>7</sub>	Device-to-Device Skew	Measured at V <sub>DD</sub> /2 on the CLKOUT pins of devices	—	0	700	ps
t <sub>j</sub>	Cycle-to-Cycle Jitter	Measured at 66.66MHz, loaded outputs	—	—	200	ps
t <sub>LOCK</sub>	PLL Lock Time	Stable power supply, valid clock presented on REF pin	—	—	1	ms

NOTES:

- REF Input has a threshold voltage of V<sub>DD</sub>/2.
- All parameters specified with loaded outputs.

SWITCHING CHARACTERISTICS (2309-1H) - COMMERCIAL<sup>(1,2)</sup>

Symbol	Parameter	Conditions	Min.	Typ.	Max.	Unit
t <sub>1</sub>	Output Frequency	10pF Load	10	—	133	MHz
		30pF Load	10	—	100	
	Duty Cycle = t <sub>2</sub> ÷ t <sub>1</sub>	Measured at 1.4V, F <sub>OUT</sub> = 66.66MHz	40	50	60	%
	Duty Cycle = t <sub>2</sub> ÷ t <sub>1</sub>	Measured at 1.4V, F <sub>OUT</sub> <50MHz	45	50	55	%
t <sub>3</sub>	Rise Time	Measured between 0.8V and 2V	—	—	1.5	ns
t <sub>4</sub>	Fall Time	Measured between 0.8V and 2V	—	—	1.5	ns
t <sub>5</sub>	Output to Output Skew	All outputs equally loaded	—	—	250	ps
t <sub>6A</sub>	Delay, REF Rising Edge to CLKOUT Rising Edge	Measured at V <sub>DD</sub> /2	—	0	±350	ps
t <sub>6B</sub>	Delay, REF Rising Edge to CLKOUT Rising Edge	Measured at V <sub>DD</sub> /2 in PLL bypass mode (IDT2309 only)	1	5	8.7	ns
t <sub>7</sub>	Device-to-Device Skew	Measured at V <sub>DD</sub> /2 on the CLKOUT pins of devices	—	0	700	ps
t <sub>8</sub>	Output Slew Rate	Measured between 0.8V and 2V using Test Circuit 2	1	—	—	V/ns
t <sub>9</sub>	Cycle-to-Cycle Jitter	Measured at 66.66MHz, loaded outputs	—	—	200	ps
t <sub>LOCK</sub>	PLL Lock Time	Stable power supply, valid clock presented on REF pin	—	—	1	ms

NOTES:

1. REF Input has a threshold voltage of V<sub>DD</sub>/2.
2. All parameters specified with loaded outputs.

DC ELECTRICAL CHARACTERISTICS - INDUSTRIAL

Symbol	Parameter	Conditions	Min.	Max.	Unit
V <sub>IL</sub>	Input LOW Voltage Level		—	0.8	V
V <sub>IH</sub>	Input HIGH Voltage Level		2	—	V
I <sub>IL</sub>	Input LOW Current	V <sub>IN</sub> = 0V	—	50	μA
I <sub>IH</sub>	Input HIGH Current	V <sub>IN</sub> = V <sub>DD</sub>	—	100	μA
V <sub>OL</sub>	Output LOW Voltage	Standard Drive	—	0.4	V
		High Drive			
V <sub>OH</sub>	Output HIGH Voltage	Standard Drive	2.4	—	V
		High Drive			
I <sub>DD_PD</sub>	Power Down Current	REF = 0MHz (S <sub>2</sub> = S <sub>1</sub> = H)	—	25	μA
I <sub>DD</sub>	Supply Current	Unloaded Outputs at 66.66MHz, SEL inputs at V <sub>DD</sub> or GND	—	35	mA

OPERATING CONDITIONS - INDUSTRIAL

Symbol	Parameter	Min.	Max.	Unit
V <sub>DD</sub>	Supply Voltage	3	3.6	V
T <sub>A</sub>	Operating Temperature (Ambient Temperature)	-40	+85	°C
C <sub>L</sub>	Load Capacitance < 100MHz	—	30	pF
	Load Capacitance 100MHz - 133MHz	—	10	
C <sub>IN</sub>	Input Capacitance	—	7	pF

SWITCHING CHARACTERISTICS (2309-1) - INDUSTRIAL<sup>(1,2)</sup>

Symbol	Parameter	Conditions	Min.	Typ.	Max.	Unit
f <sub>1</sub>	Output Frequency	10pF Load	10	—	133	MHz
		30pF Load	10	—	100	
	Duty Cycle = t <sub>2</sub> ÷ t <sub>1</sub>	Measured at 1.4V, F <sub>OUT</sub> = 66.66MHz	40	50	60	%
t <sub>3</sub>	Rise Time	Measured between 0.8V and 2V	—	—	2.5	ns
t <sub>4</sub>	Fall Time	Measured between 0.8V and 2V	—	—	2.5	ns
t <sub>5</sub>	Output to Output Skew	All outputs equally loaded	—	—	250	ps
t <sub>6A</sub>	Delay, REF Rising Edge to CLKOUT Rising Edge	Measured at V <sub>DD</sub> /2	—	0	±350	ps
t <sub>6B</sub>	Delay, REF Rising Edge to CLKOUT Rising Edge	Measured at V <sub>DD</sub> /2 in PLL bypass mode (IDT2309 only)	1	5	8.7	ns
t <sub>7</sub>	Device-to-Device Skew	Measured at V <sub>DD</sub> /2 on the CLKOUT pins of devices	—	0	700	ps
t <sub>1</sub>	Cycle-to-Cycle Jitter	Measured at 66.66MHz, loaded outputs	—	—	200	ps
t <sub>LOCK</sub>	PLL Lock Time	Stable power supply, valid clock presented on REF pin	—	—	1	ms

## NOTES:

- REF Input has a threshold voltage of V<sub>DD</sub>/2.
- All parameters specified with loaded outputs.

SWITCHING CHARACTERISTICS (2309-1H) - INDUSTRIAL<sup>(1,2)</sup>

Symbol	Parameter	Conditions	Min.	Typ.	Max.	Unit
f <sub>1</sub>	Output Frequency	10pF Load	10	—	133	MHz
		30pF Load	10	—	100	
	Duty Cycle = t <sub>2</sub> ÷ t <sub>1</sub>	Measured at 1.4V, F <sub>OUT</sub> = 66.66MHz	40	50	60	%
	Duty Cycle = t <sub>2</sub> ÷ t <sub>1</sub>	Measured at 1.4V, F <sub>OUT</sub> < 50MHz	45	50	55	%
t <sub>3</sub>	Rise Time	Measured between 0.8V and 2V	—	—	1.5	ns
t <sub>4</sub>	Fall Time	Measured between 0.8V and 2V	—	—	1.5	ns
t <sub>5</sub>	Output to Output Skew	All outputs equally loaded	—	—	250	ps
t <sub>6A</sub>	Delay, REF Rising Edge to CLKOUT Rising Edge	Measured at V <sub>DD</sub> /2	—	0	±350	ps
t <sub>6B</sub>	Delay, REF Rising Edge to CLKOUT Rising Edge	Measured at V <sub>DD</sub> /2 in PLL bypass mode (IDT2309 only)	1	5	8.7	ns
t <sub>7</sub>	Device-to-Device Skew	Measured at V <sub>DD</sub> /2 on the CLKOUT pins of devices	—	0	700	ps
t <sub>8</sub>	Output Slew Rate	Measured between 0.8V and 2V using Test Circuit 2	1	—	—	V/ns
t <sub>1</sub>	Cycle-to-Cycle Jitter	Measured at 66.66MHz, loaded outputs	—	—	200	ps
t <sub>LOCK</sub>	PLL Lock Time	Stable power supply, valid clock presented on REF pin	—	—	1	ms

## NOTES:

- REF Input has a threshold voltage of V<sub>DD</sub>/2.
- All parameters specified with loaded outputs.

## ZERO DELAY AND SKEW CONTROL

All outputs should be uniformly loaded in order to achieve Zero I/O Delay. Since the CLKOUT pin is the internal feedback for the PLL, its relative loading can affect and adjust the input/output delay. The Output Load Difference diagram illustrates the PLL's relative loading with respect to the other outputs that can adjust the Input-Output (I/O) Delay.

For designs utilizing zero I/O Delay, all outputs including CLKOUT must be equally loaded. Even if the output is not used, it must have a capacitive load equal to that on the other outputs in order to obtain true zero I/O Delay. If I/O Delay adjustments are needed, use the Output Load Difference diagram to calculate loading differences between the CLKOUT pin and other outputs. For zero output-to-output skew, all outputs must be loaded equally.

REF TO CLKA/CLKB RELAY vs. OUTPUT LOAD DIFFERENCE BETWEEN CLKOUT PIN AND CLKA/CLKB PINS

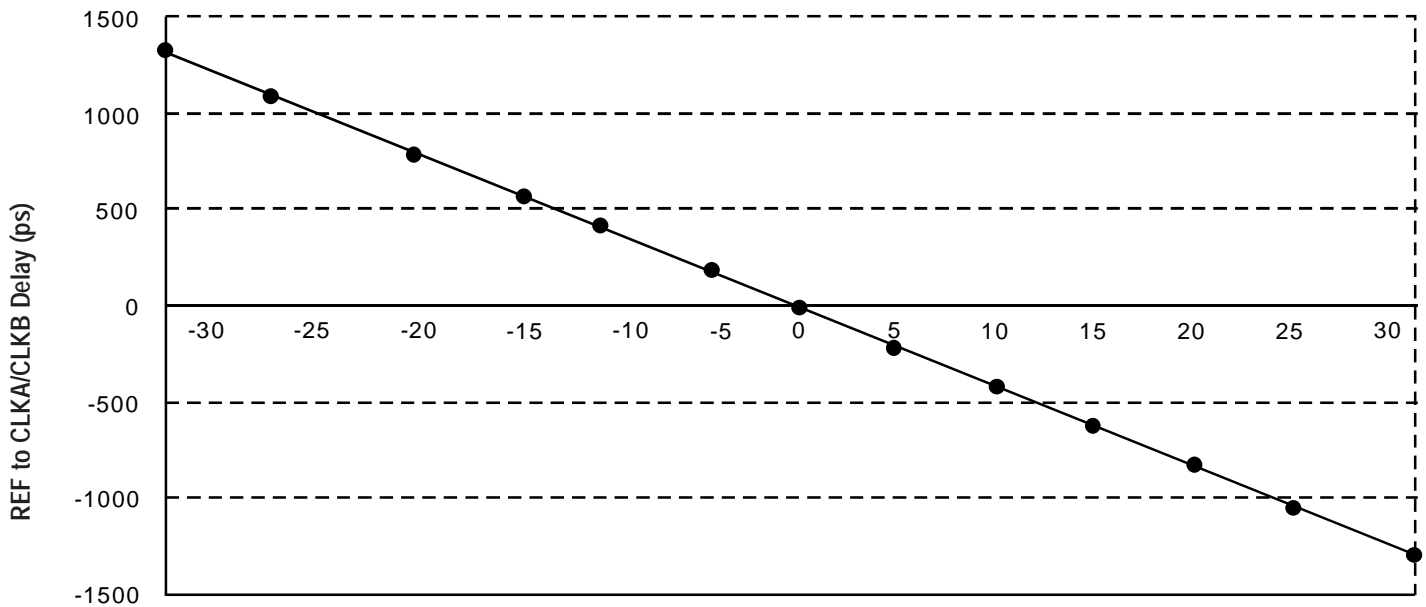

OUTPUT LOAD DIFFERENCE BETWEEN CLKOUT PIN AND CLKA/CLKB PINS (pF)

## SWITCHING WAVEFORMS

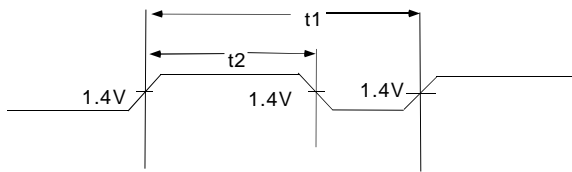

*Duty Cycle Timing*

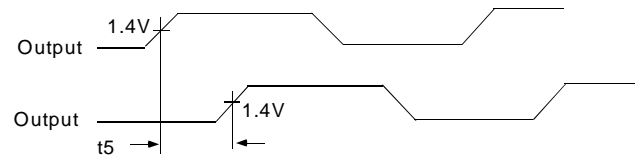

*Output to Output Skew*

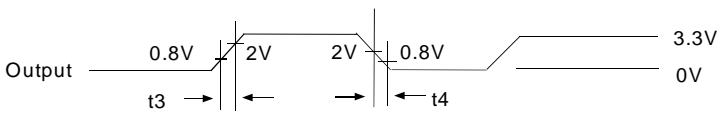

*All Outputs Rise/Fall Time*

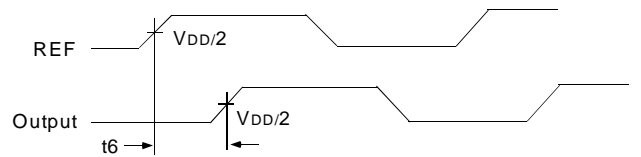

*Input to Output Propagation Delay*

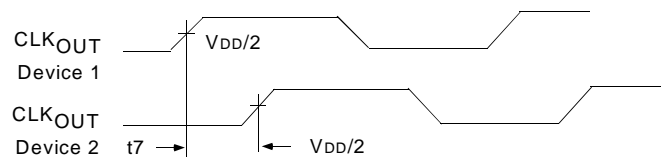

*Device to Device Skew*

## TEST CIRCUITS

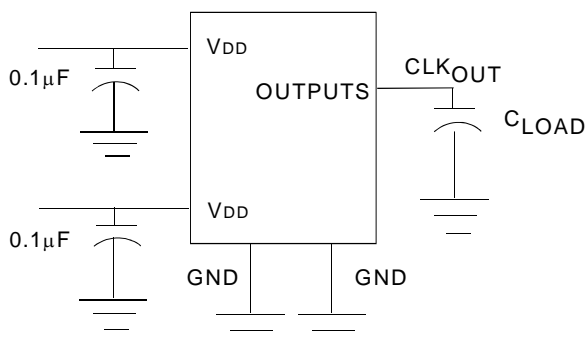

*Test Circuit 1 (all Parameters Except t8)*

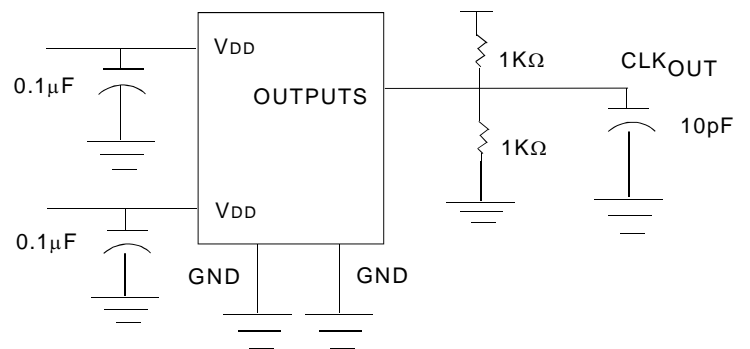

*Test Circuit 2 (t8, Output Slew Rate On -1H Devices)*

## TYPICAL DUTY CYCLE<sup>(1)</sup> AND I<sub>DD</sub> TRENDS<sup>(2)</sup> FOR IDT2309-1

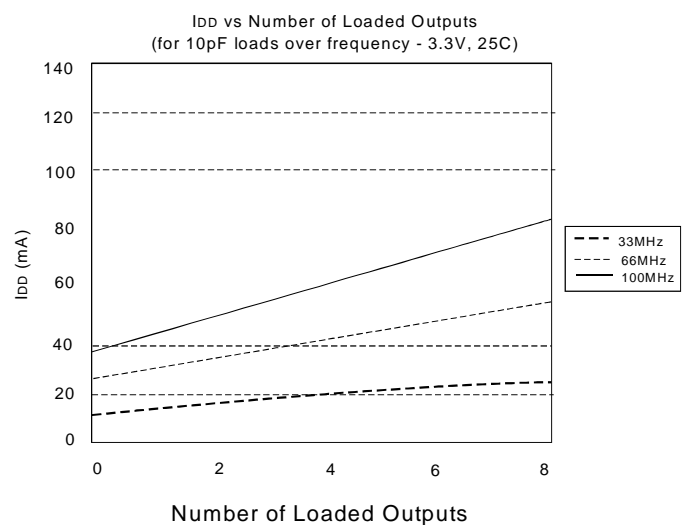
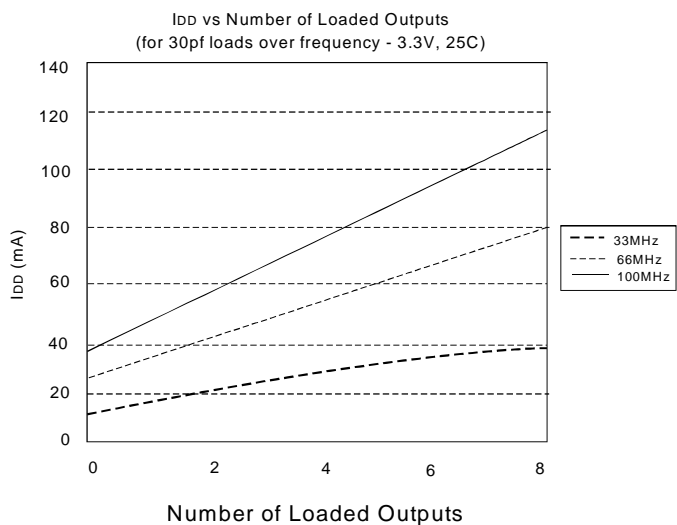
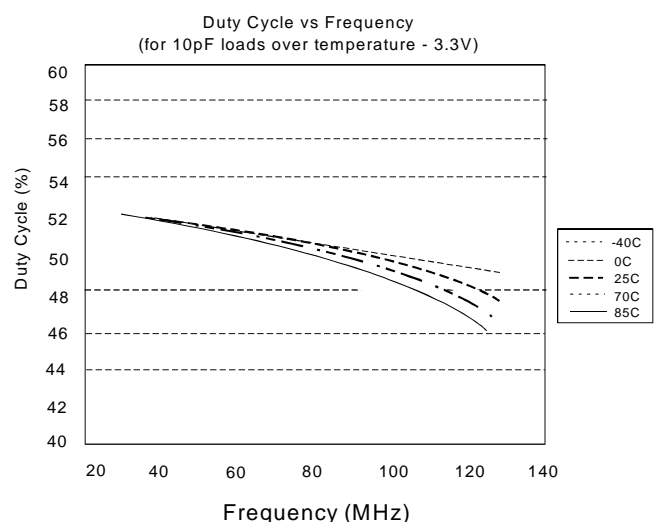
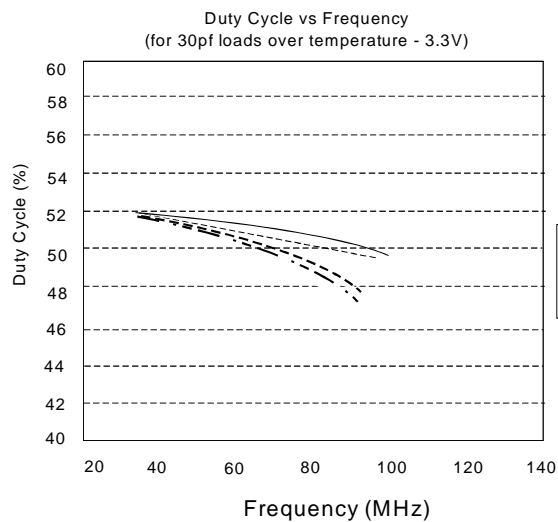
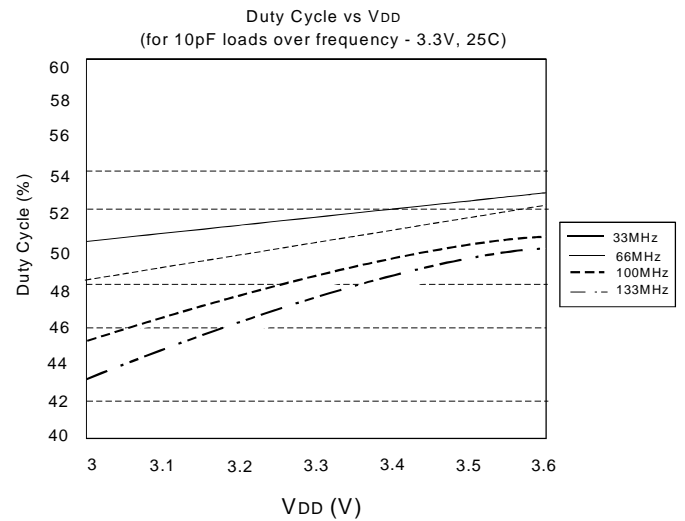
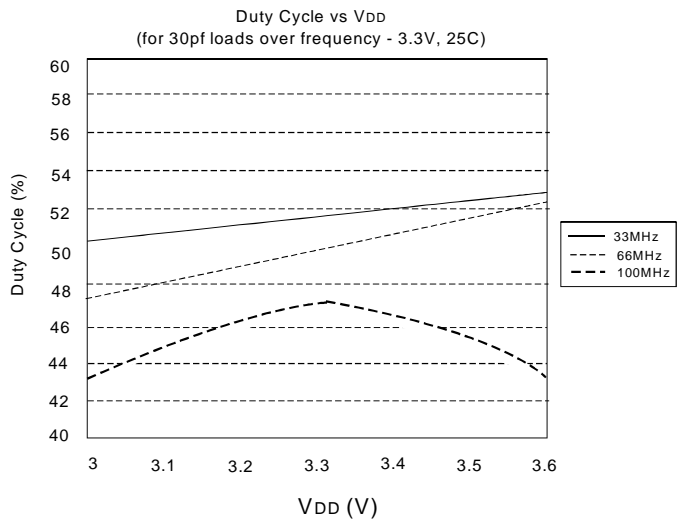

**NOTES:**

- Duty Cycle is taken from typical chip measured at 1.4V.
- I<sub>DD</sub> data is calculated from  $I_{DD} = I_{CORE} + nCVf$ , where I<sub>CORE</sub> is the unloaded current. (n = Number of outputs; C = Capacitance load per output (F); V = Supply Voltage (V); f = Frequency (Hz))



TYPICAL DUTY CYCLE<sup>(1)</sup> AND I<sub>DD</sub> TRENDS<sup>(2)</sup> FOR IDT2309-1H

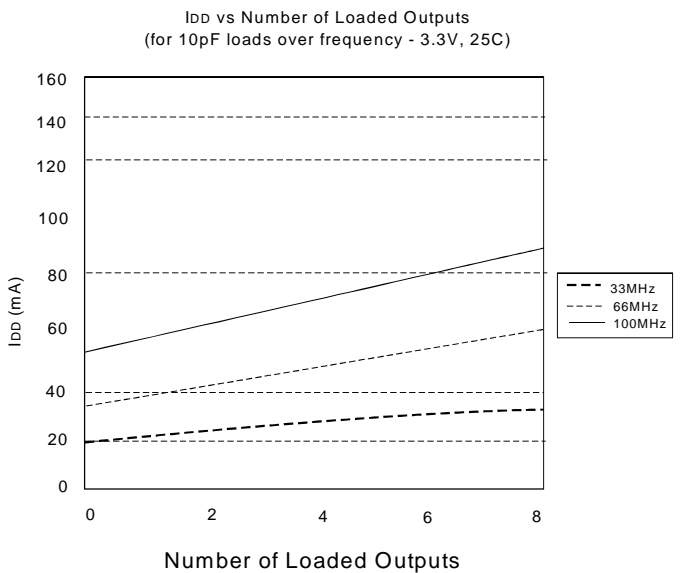
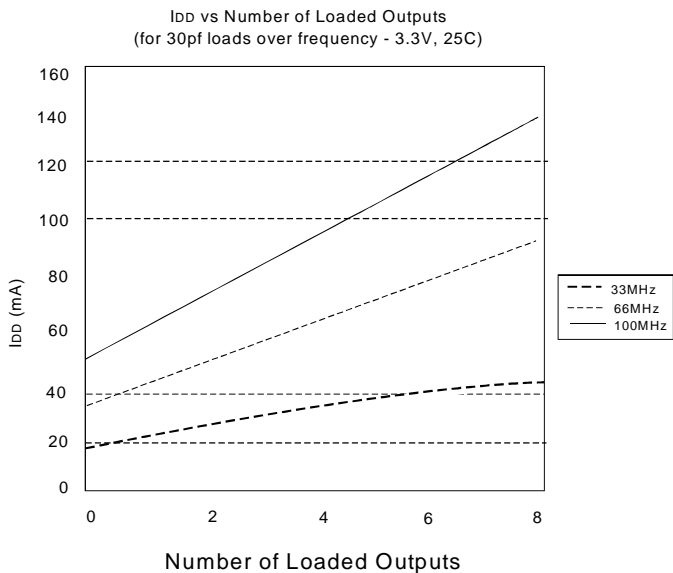
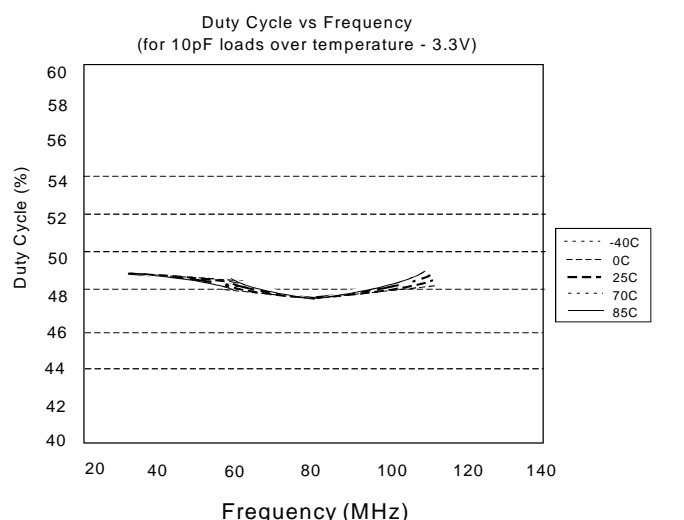
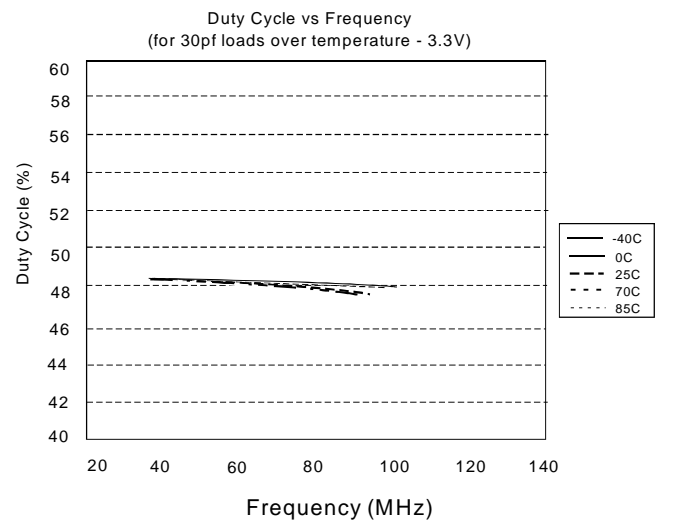
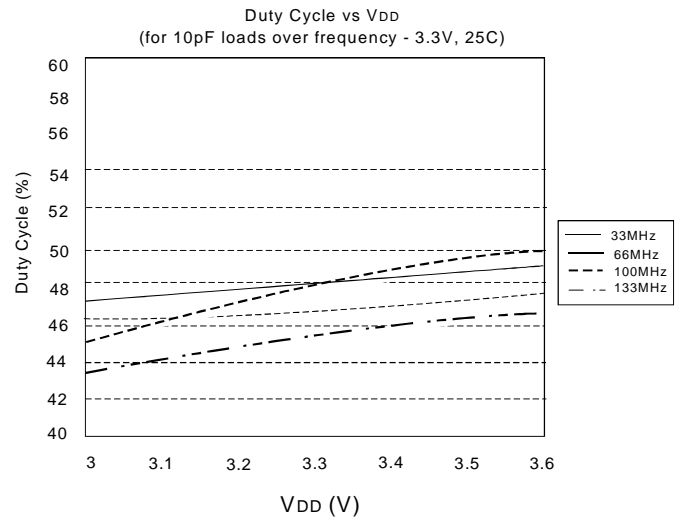
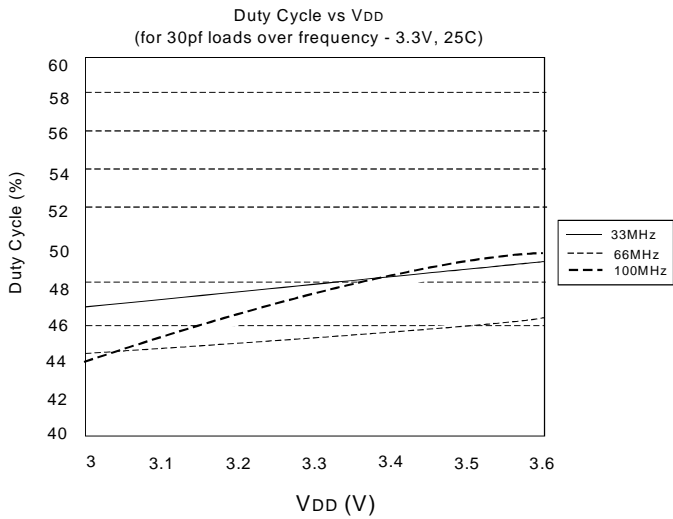

NOTES:

- Duty Cycle is taken from typical chip measured at 1.4V.
- I<sub>DD</sub> data is calculated from  $I_{DD} = I_{CORE} + nCfV$ , where I<sub>CORE</sub> is the unloaded current. (n = Number of outputs; C = Capacitance load per output (F); V = Supply Voltage (V); f = Frequency (Hz))

**ORDERING INFORMATION**

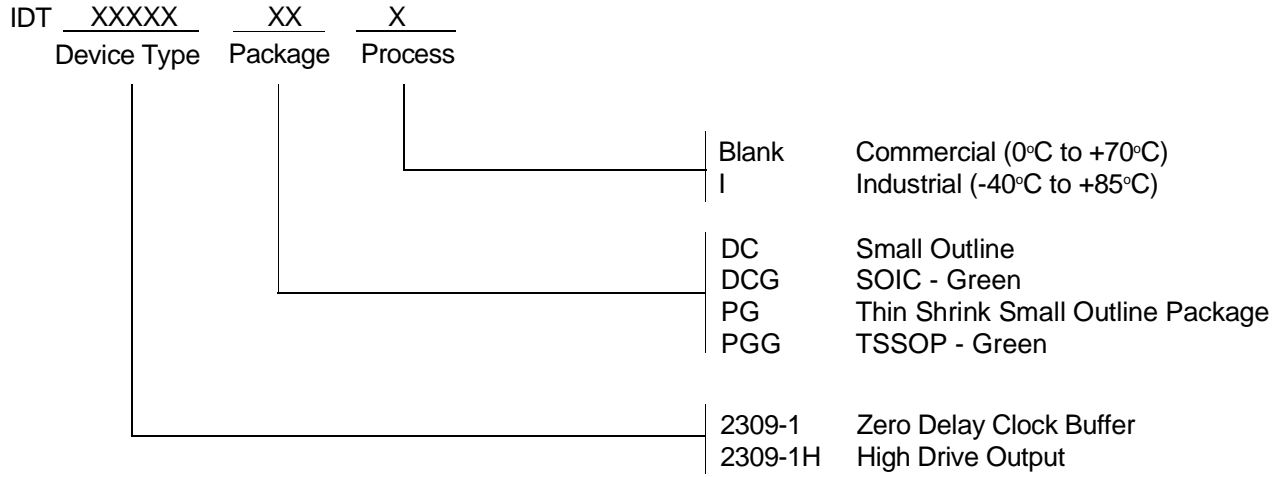

Ordering Code	Package Type	Operating Range
IDT2309-1DC	16-Pin SOIC	Commercial
IDT2309-1DCI	16-Pin SOIC	Industrial
IDT2309-1HDC	16-Pin SOIC	Commercial
IDT2309-1HDCG	16-Pin SOIC	Commercial
IDT2309-1HDCI	16-Pin SOIC	Industrial
IDT2309-1HDCGI	16-Pin SOIC	Industrial
IDT2309-1HPG	16-Pin TSSOP	Commercial
IDT2309-1HPGG	16-Pin TSSOP	Commercial
IDT2309-1HPGI	16-Pin TSSOP	Industrial
IDT2309-1HPGGI	16-Pin TSSOP	Industrial



**CORPORATE HEADQUARTERS**  
 2975 Stender Way  
 Santa Clara, CA 95054

**for SALES:**  
 800-345-7015 or 408-727-6116  
 fax: 408-492-8674  
 www.idt.com

**for Tech Support:**  
 logichelp@idt.com  
 (408) 654-6459