

**Features**

- 200MHz gain-bandwidth product
- Unity-gain stable
- Ultra low video distortion = 0.01%/0.015° @ NTSC/PAL
- Conventional voltage-feedback topology
- Low offset voltage = 200µV
- Low bias current = 2µA
- Low offset current = 0.1µA
- Output current = 50mA over temperature
- Fast settling = 13ns to 0.1%
- Low distortion = -60dB HD2, -70dB HD3 @ 20MHz, 2V<sub>PP</sub>, A<sub>V</sub> = +1

**Applications**

- High resolution video
- Active filters/integrators
- High-speed signal processing
- ADC/DAC buffers
- Pulse/RF amplifiers
- Pin diode receivers
- Log amplifiers
- Photo multiplier amplifiers
- High speed sample-and-holds

**Ordering Information**

Part No.	Temp. Range	Package	Outline #
EL2073CN	-40°C to +85°C	8-Pin P-DIP	MDP0031
EL2073CS	-40°C to +85°C	8-Lead SO	MDP0027

**General Description**

The EL2073C is a precision voltage-feedback amplifier featuring a 200MHz gain-bandwidth product, fast settling time, excellent differential gain and differential phase performance, and a minimum of 50mA output current drive over temperature.

The EL2073C is unity-gain stable with a -3dB bandwidth of 400MHz. It has a very low 200µV of input offset voltage, only 2µA of input bias current, and a fully symmetrical differential input. Like all voltage-feedback operational amplifiers, the EL2073C allows the use of reactive or non-linear components in the feedback loop. This combination of speed and versatility makes the EL2073C the ideal choice for all op-amp applications requiring high speed and precision, including active filters, integrators, sample-and-holds, and log amps. The low distortion, high output current, and fast settling makes the EL2073C an ideal amplifier for signal-processing and digitizing systems.

**Connection Diagrams**

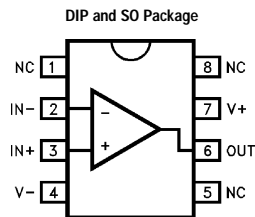

Note: All information contained in this data sheet has been carefully checked and is believed to be accurate as of the date of publication; however, this data sheet cannot be a "controlled document". Current revisions, if any, to these specifications are maintained at the factory and are available upon your request. We recommend checking the revision level before finalization of your design documentation.

# EL2073C

## 200MHz Unity-Gain Stable Operational Amplifier

### Absolute Maximum Ratings ( $T_A = 25^\circ\text{C}$ )

Supply Voltage ( $V_S$ )	$\pm 7\text{V}$	Thermal Resistance	$\theta_{JA} = 95^\circ\text{C/W P-DIP}$
Output Current			$\theta_{JA} = 175^\circ\text{C/W SO-8}$
Output is short-circuit protected to ground, however, maximum reliability is obtained if $I_{OUT}$ does not exceed 70mA.		Operating Temperature	$-40^\circ\text{C}$ to $+85^\circ\text{C}$
Common-Mode Input	$\pm V_S$	Junction Temperature	$175^\circ\text{C}$
Differential Input Voltage	5V	Storage Temperature	$-60^\circ\text{C}$ to $+150^\circ\text{C}$
		Note: See EL2071/EL2171 for Thermal Impedance curves.	

#### Important Note:

All parameters having Min/Max specifications are guaranteed. Typ values are for information purposes only. Unless otherwise noted, all tests are at the specified temperature and are pulsed tests, therefore:  $T_J = T_C = T_A$ .

### Open Loop DC Electrical Characteristics

$V_S = \pm 5\text{V}$ ,  $R_L = 100\Omega$ , unless otherwise specified

Parameter	Description	Test Conditions	Temp	Min	Typ	Max	Unit
$V_{OS}$	Input Offset Voltage	$V_{CM} = 0\text{V}$	25°C		0.2	1.5	mV
			$T_{MIN}, T_{MAX}$			3	mV
$TCV_{OS}$	Average Offset Voltage Drift	[1]	All		8		$\mu\text{V}/^\circ\text{C}$
$I_B$	Input Bias Current		25°C		2	6	$\mu\text{A}$
			$T_{MIN}, T_{MAX}$		2	6	$\mu\text{A}$
$I_{OS}$	Input Offset Current	$V_{CM} = 0\text{V}$	25°C		0.1	1	$\mu\text{A}$
			$T_{MIN}, T_{MAX}$			2	$\mu\text{A}$
PSRR	Power Supply Rejection Ratio	[2]	25°C	60	80		dB
			$T_{MIN}, T_{MAX}$	60			dB
CMRR	Common Mode Rejection Ratio	[3]	25°C	65	90		dB
			$T_{MIN}, T_{MAX}$	65			dB
$I_S$	Supply Current—Quiescent	No Load	25°C		21	25	mA
			$T_{MIN}, T_{MAX}$			25	mA
$R_{IN}(\text{diff})$	$R_{IN}(\text{Differential})$	Open-Loop	25°C		15		k $\Omega$
$C_{IN}(\text{diff})$	$C_{IN}(\text{Differential})$	Open-Loop	25°C		1		pF
$R_{IN}(\text{cm})$	$R_{IN}(\text{Common-Mode})$		25°C		1		M $\Omega$
$C_{IN}(\text{cm})$	$C_{IN}(\text{Common-Mode})$		25°C		1		pF
$R_{OUT}$	Output Resistance		25°C		20		m $\Omega$
CMIR	Common-Mode Input Range		25°C	$\pm 3$	$\pm 3.5$		V
			$T_{MIN}, T_{MAX}$	$\pm 2.5$			V
$I_{OUT}$	Output Current		25°C	50	70		mA
			$T_{MIN}, T_{MAX}$	50			mA
$V_{OUT}$	Output Voltage Swing	No Load	25°C	$\pm 3.5$	$\pm 4$		V
			$T_{MIN}, T_{MAX}$	$\pm 3.5$			V
$V_{OUT 100}$	Output Voltage Swing	100 $\Omega$	25°C	$\pm 3$	$\pm 3.6$		V
			$T_{MIN}, T_{MAX}$	$\pm 3$			V
$V_{OUT 50}$	Output Voltage Swing	50 $\Omega$	25°C	$\pm 3$	$\pm 3.4$		V
			$T_{MIN}, T_{MAX}$	$\pm 2.5$			V
$A_{VOL 100}$	Open-Loop Gain	100 $\Omega$	25°C	500	1000		V/V
			$T_{MIN}, T_{MAX}$	400			V/V

### Open Loop DC Electrical Characteristics (Continued)

$V_S = \pm 5V$ ,  $R_L = 100\Omega$ , unless otherwise specified

Parameter	Description	Test Conditions	Temp	Min	Typ	Max	Unit
A <sub>VOL</sub> 50	Open-Loop Gain	50Ω	25°C	400	800		V/V
			T <sub>MIN</sub> , T <sub>MAX</sub>	300			V/V
eN@ > 1MHz	Noise Voltage 1–100MHz		25°C		2.3		nV/√Hz
iN@ > 100kHz	Noise Current 100k–100MHz		25°C		3.2		pA/√Hz

1. Measured from T<sub>MIN</sub>, T<sub>MAX</sub>.
2. ±V<sub>CC</sub> = ±4.5V to 5.5V.
3. ±V<sub>IN</sub> = ±2.5V, V<sub>OUT</sub> = 0V

### Closed Loop AC Electrical Characteristics

$V_S = \pm 5V$ , A<sub>V</sub> = +1, R<sub>f</sub> = 0Ω, R<sub>L</sub> = 100Ω unless otherwise specified

Parameter	Description	Test Conditions	Temp	Min	Typ	Max	Unit
SSBW	-3dB Bandwidth (V <sub>OUT</sub> = 0.4V <sub>pp</sub> )	A <sub>V</sub> = +1	25°C	150	300		MHz
		A <sub>V</sub> = -1	25°C		200		MHz
		A <sub>V</sub> = +2	25°C	150	200		MHz
			T <sub>MIN</sub> , T <sub>MAX</sub>	125			MHz
		A <sub>V</sub> = +5	25°C		40		MHz
		A <sub>V</sub> = +10	25°C		20		MHz
GBWP	Gain-Bandwidth Product	A <sub>V</sub> = +10	25°C		200		MHz
LSBWa	-3dB Bandwidth	V <sub>OUT</sub> = 2V <sub>pp</sub> <sup>[1]</sup>	All	50	85		MHz
LSBWb	-3dB Bandwidth	V <sub>OUT</sub> = 5V <sub>pp</sub> <sup>[1]</sup>	All	11	16		MHz
GFPL	Peaking (<50MHz)	V <sub>OUT</sub> = 0.4V <sub>pp</sub>	25°C		0	0.5	dB
			T <sub>MIN</sub> , T <sub>MAX</sub>			0.5	dB
GFPH	Peaking (>50MHz)	V <sub>OUT</sub> = 0.4V <sub>pp</sub>	25°C		1	3	dB
			T <sub>MIN</sub> , T <sub>MAX</sub>			3	dB
GFR	Roll-off (<100MHz)	V <sub>OUT</sub> = 0.4V <sub>pp</sub>	25°C		0.1	0.5	dB
			T <sub>MIN</sub> , T <sub>MAX</sub>			0.5	dB
LPD	Linear Phase Deviation (<100MHz)	V <sub>OUT</sub> = 0.4V <sub>pp</sub>	All		1	1.8	°
PM	Phase Margin	A <sub>V</sub> = +1	25°C		60		°
tr1, tf1	Rise Time, Fall Time	0.4V Step, A <sub>V</sub> = +2	25°C		2		ns
tr2, tf2	Rise Time, Fall Time	5V Step, A <sub>V</sub> = +2	25°C		15		ns
ts1	Settling to 0.1% (A <sub>V</sub> = -1)	2V Step	25°C		13		ns
ts2	Settling to 0.01% (A <sub>V</sub> = -1)	2V Step	25°C		25		ns
OS	Overshoot	2V Step	25°C		5		%
SR	Slew Rate	2V Step	All	175	250		V/μs
DISTORTION <sup>[2]</sup>							
HD2a	2nd Harmonic Distortion	@ 10MHz, A <sub>V</sub> = +2	25°C		-65	-55	dBc
HD2b	2nd Harmonic Distortion	@ 20MHz, A <sub>V</sub> = +1	25°C		-60	-50	dBc
HD2c	2nd Harmonic Distortion	@ 20MHz, A <sub>V</sub> = +2	25°C		-55	-50	dBc
			T <sub>MIN</sub> , T <sub>MAX</sub>			-45	dBc
HD3a	3rd Harmonic Distortion	@ 10MHz, A <sub>V</sub> = +2	25°C		-72	-60	dBc
HD3b	3rd Harmonic Distortion	@ 20MHz, A <sub>V</sub> = +1	25°C		-70	-55	dBc
HD3c	3rd Harmonic Distortion	@ 20MHz, A <sub>V</sub> = +2	25°C		-70	-60	dBc
			T <sub>MIN</sub> , T <sub>MAX</sub>			-60	dBc

**EL2073C****200MHz Unity-Gain Stable Operational Amplifier****Closed Loop AC Electrical Characteristics** $V_S = \pm 5V$ ,  $A_V = +1$ ,  $R_f = 0\Omega$ ,  $R_L = 100\Omega$  unless otherwise specified

Parameter	Description	Test Conditions	Temp	Min	Typ	Max	Unit
VIDEO PERFORMANCE <sup>[3]</sup>							
dG	Differential Gain	NTSC	25°C		0.01	0.05	%pp
dP	Differential Phase	NTSC	25°C		0.015	0.05	°pp
dG	Differential Gain	30MHz	25°C		0.1		%pp
dP	Differential Phase	30MHz	25°C		0.1		°pp
VBW	±0.1dB Bandwidth Flatness		25°C	25	50		MHz

1. Large-signal bandwidth calculated using  $LSBW = \text{Slew Rate} / 2\pi V_{PEAK}$ .
2. All distortion measurements are made with  $V_{OUT} = 2V_{PP}$ ,  $R_L = 100\Omega$
3. Video performance measured at  $A_V = +1$  with 2 times normal video level across  $R_L = 100\Omega$ . This corresponds to standard video levels across a back-terminated 50 $\Omega$  load, i.e., 0–100 IRE, 40IREpp giving a 1Vpp video signal across the 50 $\Omega$  load. For other values of  $R_L$ , see curves.

### Typical Performance Curves

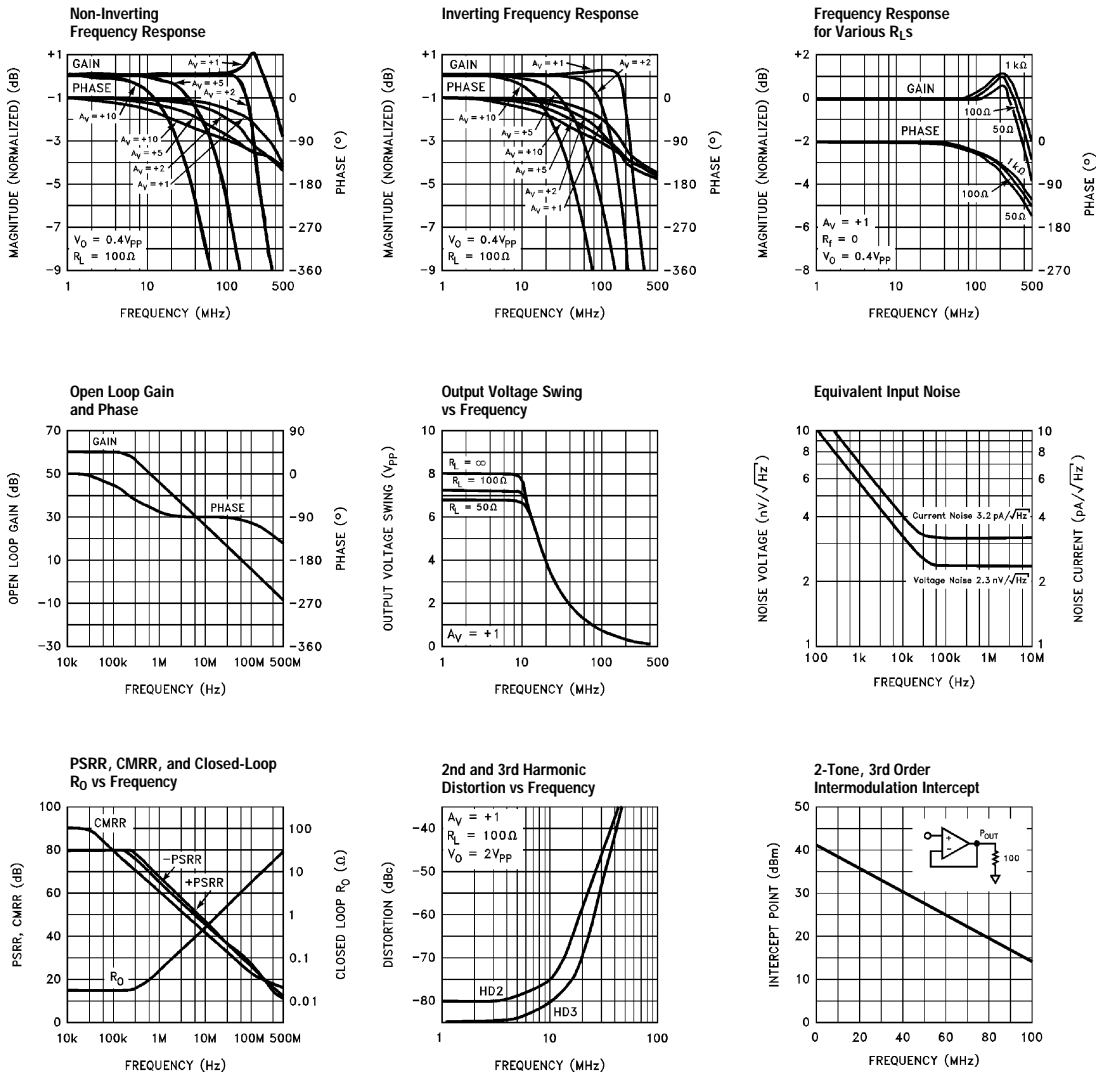

# EL2073C

200MHz Unity-Gain Stable Operational Amplifier

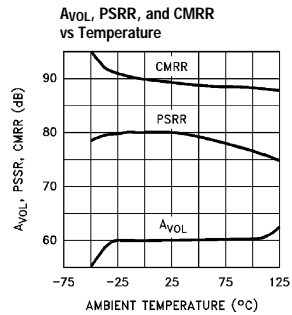
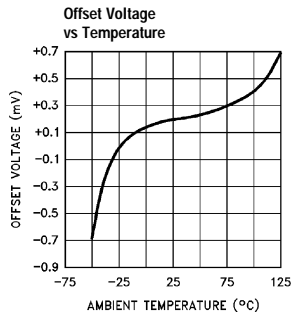
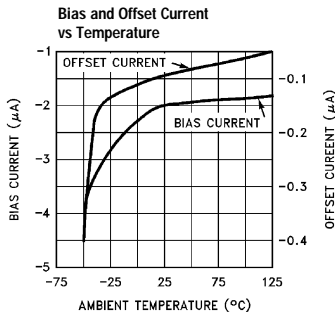
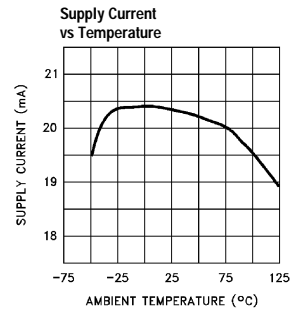
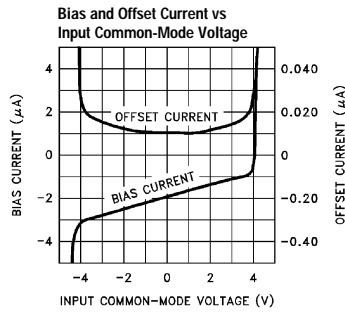
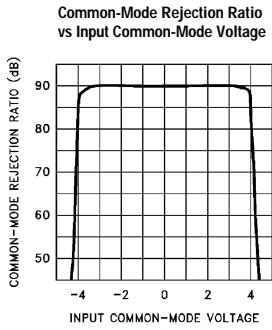
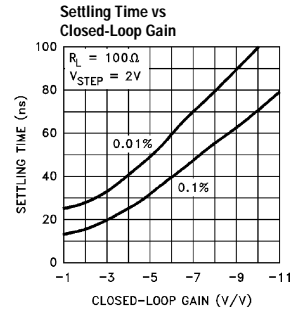
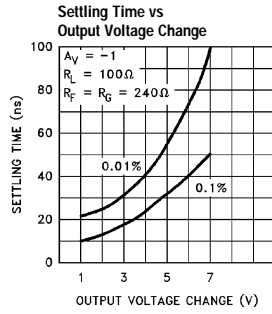
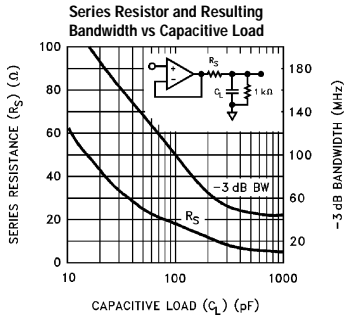

# EL2073C

## 200MHz Unity-Gain Stable Operational Amplifier

EL2073C

Small Signal Transient Response

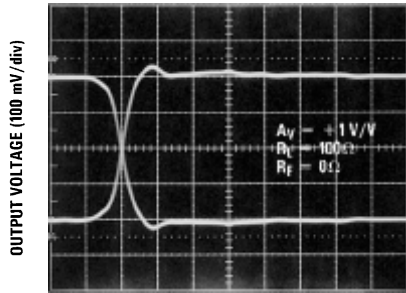

TIME (2 ns/div)

Large Signal Transient Response

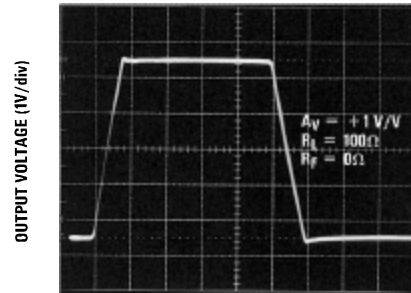

TIME (20 ns/div)

Differential Gain and Phase vs DC Input Offset at 3.58MHz

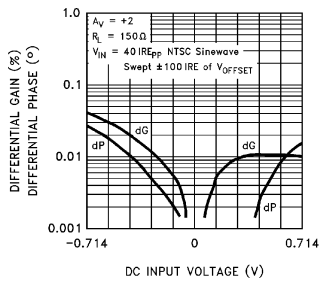

Differential Gain and Phase vs DC Input Offset at 4.43MHz

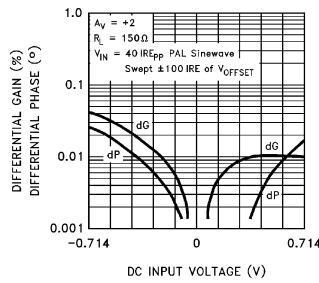

Differential Gain and Phase vs DC Input Offset at 30MHz

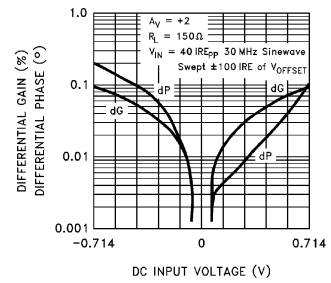

Differential Gain and Phase vs Number of 150 Ohm Loads at 3.58MHz

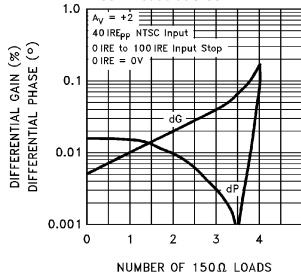

Differential Gain and Phase vs Number of 150 Ohm Loads at 4.43MHz

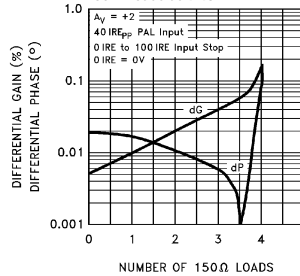

Differential Gain and Phase vs Number of 150 Ohm Loads at 30MHz

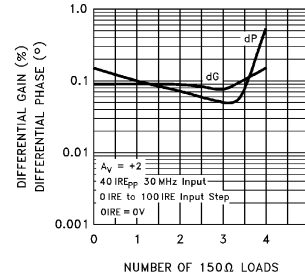

# EL2073C

200MHz Unity-Gain Stable Operational Amplifier

## Equivalent Circuit

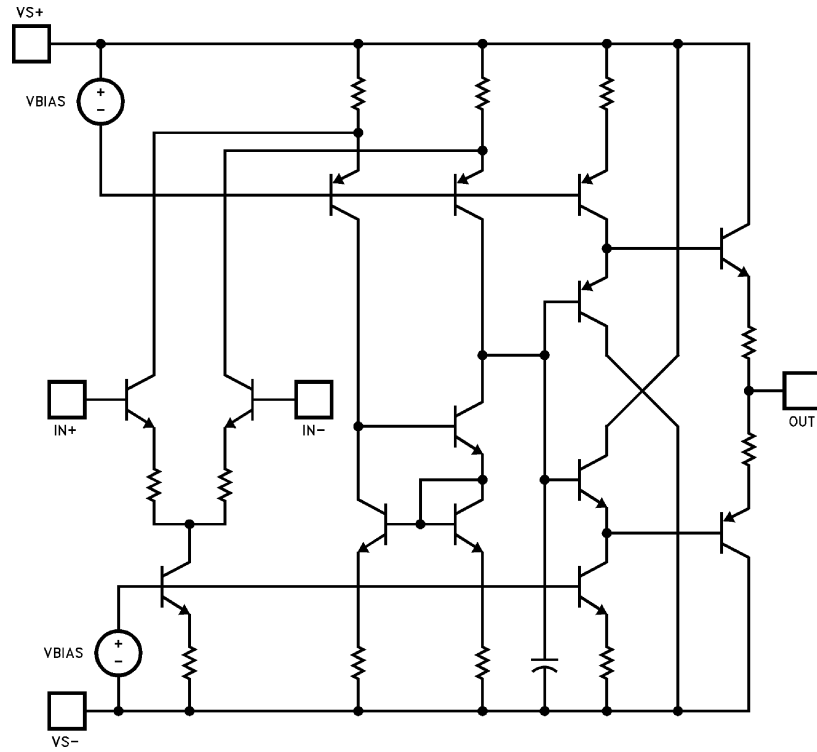

## Burn-In Circuit

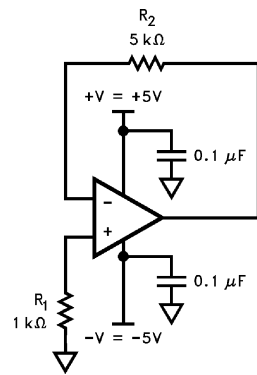

All Packages Use The Same Schematic

## Applications Information

### Product Description

The EL2073C is a wideband monolithic operational amplifier built on a high-speed complementary bipolar process. The EL2073C uses a classical voltage-feedback topology which allows it to be used in a variety of applications where current-feedback amplifiers are not appropriate because of restrictions placed upon the feedback element used with the amplifier. The conventional topology of the EL2073C allows, for example, a capacitor to be placed in the feedback path, making it an excellent choice for applications such as active filters, sample-and-holds, or integrators. Similarly, because of the ability to use diodes in the feedback network, the EL2073C is an excellent choice for applications such as log amplifiers.

The EL2073C also has excellent DC specifications:  $200\mu\text{V}$ ,  $V_{OS}$ ,  $2\mu\text{A}$   $I_B$ ,  $0.1\mu\text{A}$   $I_{OS}$ , and 90dB of CMRR. These specifications allow the EL2073C to be used in DC-sensitive applications such as difference amplifiers. Furthermore, the current noise of the EL2073C is only 3.2 pA/Hz, making it an excellent choice for high-sensitivity transimpedance amplifier configurations.

### Gain-Bandwidth Product

The EL2073C has a gain-bandwidth product of 200MHz. For gains greater than 4, its closed-loop -3dB bandwidth is approximately equal to the gain-bandwidth product divided by the noise gain of the circuit. For gains less than 4, higher-order poles in the amplifier's transfer function contribute to even higher closed loop bandwidths. For example, the EL2073C has a -3dB bandwidth of 400MHz at a gain of +1, dropping to 200MHz at a gain of +2. It is important to note that the EL2073C has been designed so that this "extra" bandwidth in low-gain applications does not come at the expense of stability. As seen in the typical performance curves, the EL2073C in a gain of +1 only exhibits 1dB of peaking with a 100Ω load.

### Video Performance

An industry-standard method of measuring the video distortion of a component such as the EL2073C is to measure the amount of differential gain (dG) and differ-

ential phase (dP) that it introduces. To make these measurements, a  $0.286\text{V}_{PP}$  (40 IRE) signal is applied to the device with 0V DC offset (0 IRE) at either 3.58MHz for NTSC, 4.43MHz for PAL, or 30MHz for HDTV. A second measurement is then made at 0.714V DC offset (100 IRE). Differential gain is a measure of the change in amplitude of the sine wave, and is measured in percent. Differential phase is a measure of the change in phase, and is measured in degrees.

For signal transmission and distribution, a back-terminated cable ( $75\Omega$  in series at the drive end, and  $75\Omega$  to ground at the receiving end) is preferred since the impedance match at both ends will absorb any reflections. However, when double termination is used, the received signal is halved; therefore a gain of 2 configuration is typically used to compensate for the attenuation.

The EL2073C has been designed to be among the best video amplifiers in the marketplace today. It has been thoroughly characterized for video performance in the topology described above, and the results have been included as minimum dG and dP specifications and as typical performance curves. In a gain of +2, driving  $150\Omega$ , with standard video test levels at the input, the EL2073C exhibits dG and dP of only 0.01% and  $0.015^\circ$  at NTSC and PAL. Because dG and dP vary with different DC offsets, the superior video performance of the EL2073C has been characterized over the entire DC offset range from -0.714V to +0.714V. For more information, refer to the curves of dG and dP vs DC Input Offset.

The excellent output drive capability of the EL2073C allows it to drive up to 4 back-terminated loads with excellent video performance. With 4  $150\Omega$  loads, dG and dP are only 0.15% and  $0.08^\circ$  at NTSC and PAL. For more information, refer to the curves for Video Performance vs Number of  $150\Omega$  Loads.

### Output Drive Capability

The EL2073C has been optimized to drive  $50\Omega$  and  $75\Omega$  loads. It can easily drive  $6\text{V}_{PP}$  into a  $50\Omega$  load. This high output drive capability makes the EL2073C an ideal choice for RF, IF and video applications. Furthermore,

## ***EL2073C***

### ***200MHz Unity-Gain Stable Operational Amplifier***

the current drive of the EL2073C remains a minimum of 50mA at low temperatures. The EL2073C is current-limited at the output, allowing it to withstand momentary shorts to ground. However, power dissipation with the output shorted can be in excess of the power-dissipation capabilities of the package.

#### **Capacitive Loads**

Although the EL2073C has been optimized to drive resistive loads as low as 50 $\Omega$ , capacitive loads will decrease the amplifier's phase margin which may result in peaking, overshoot, and possible oscillation. For optimum AC performance, capacitive loads should be reduced as much as possible or isolated via a series output resistor. Coax lines can be driven, as long as they are terminated with their characteristic impedance. When properly terminated, the capacitance of coaxial cable will not add to the capacitive load seen by the amplifier. Capacitive loads greater than 10pF should be buffered with a series resistor ( $R_s$ ) to isolate the load capacitance from the amplifier output. A curve of recommended  $R_s$  vs  $C_{load}$  has been included for reference. Values of  $R_s$  were chosen to maximize resulting bandwidth without peaking.

#### **Printed-Circuit Layout**

As with any high-frequency device, good PCB layout is necessary for optimum performance. Ground-plane construction is highly recommended, as is good power supply bypassing. A 1 $\mu$ F–10 $\mu$ F tantalum capacitor is recommended in parallel with a 0.01 $\mu$ F ceramic capacitor. All lead lengths should be as short as possible, and all bypass capacitors should be as close to the device pins as possible. Parasitic capacitances should be kept to an absolute minimum at both inputs and at the output. Resistor values should be kept under 1000 $\Omega$  to 2000 $\Omega$  because of the RC time constants associated with the parasitic capacitance. Metal-film and carbon resistors are both acceptable, use of wire-wound resistors is not recommended because of parasitic inductance. Similarly, capacitors should be low-inductance for best performance. If possible, solder the EL2073C directly to the PC board without a socket. Even high quality sockets add parasitic capacitance and inductance which can potentially degrade performance. Because of the degradation of AC performance due to parasitics, the use of

surface-mount components (resistors, capacitors, etc.) is also recommended.



**EL2073C****200MHz Unity-Gain Stable Operational Amplifier****General Disclaimer**

Specifications contained in this data sheet are in effect as of the publication date shown. Elantec, Inc. reserves the right to make changes in the circuitry or specifications contained herein at any time without notice. Elantec, Inc. assumes no responsibility for the use of any circuits described herein and makes no representations that they are free from patent infringement.

**élantec**

HIGH PERFORMANCE ANALOG INTEGRATED CIRCUITS

**Elantec Semiconductor, Inc.**

675 Trade Zone Blvd.

Milpitas, CA 95035

Telephone: (408) 945-1323

(888) ELANTEC

Fax: (408) 945-9305

European Office: +44-118-977-6020

Japan Technical Center: +81-45-682-5820

**WARNING - Life Support Policy**

Elantec, Inc. products are not authorized for and should not be used within Life Support Systems without the specific written consent of Elantec, Inc. Life Support systems are equipment intended to support or sustain life and whose failure to perform when properly used in accordance with instructions provided can be reasonably expected to result in significant personal injury or death. Users contemplating application of Elantec, Inc. Products in Life Support Systems are requested to contact Elantec, Inc. factory headquarters to establish suitable terms & conditions for these applications. Elantec, Inc.'s warranty is limited to replacement of defective components and does not cover injury to persons or property or other consequential damages.

This datasheet has been download from:

[www.datasheetcatalog.com](http://www.datasheetcatalog.com)

Datasheets for electronics components.