



RF Power Field Effect Transistors

N-Channel Enhancement-Mode Lateral MOSFETs

Designed for PCN and PCS base station applications with frequencies from 2100 to 2200 MHz. Suitable for W-CDMA, CDMA, TDMA, GSM and multicarrier amplifier applications.

- Typical 2-Carrier W-CDMA Performance: $V_{DD} = 28$ Volts, $I_{DQ} = 500$ mA, $P_{out} = 6$ Watts Avg., Full Frequency Band, Channel Bandwidth = 3.84 MHz, PAR = 8.5 dB @ 0.01% Probability on CCDF.
 Power Gain — 12.5 dB
 Drain Efficiency — 15%
 ACPR @ 5 MHz Offset — -47 dBc in 3.84 MHz Channel Bandwidth
- Capable of Handling 10:1 VSWR, @ 28 Vdc, 2140 MHz, 60 Watts CW Output Power

Features

- Internally Matched for Ease of Use
- High Gain, High Efficiency and High Linearity
- Integrated ESD Protection
- Designed for Maximum Gain and Insertion Phase Flatness
- Excellent Thermal Stability
- Characterized with Series Equivalent Large-Signal Impedance Parameters
- Available with Low Gold Plating Thickness on Leads. L Suffix Indicates 40 μ m Nominal.
- RoHS Compliant
- In Tape and Reel. R3 Suffix = 250 Units per 56 mm, 13 Inch Reel.

MRF21060LR3
MRF21060LSR3

2110-2170 MHz, 60 W, 28 V
LATERAL N-CHANNEL
RF POWER MOSFETs

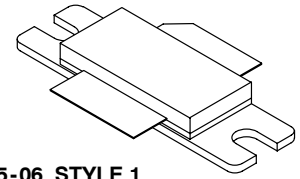

CASE 465-06, STYLE 1
NI-780
MRF21060LR3

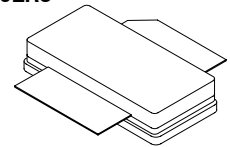

CASE 465A-06, STYLE 1
NI-780S
MRF21060LSR3

Table 1. Maximum Ratings

Rating	Symbol	Value	Unit
Drain-Source Voltage	V_{DSS}	-0.5, +65	Vdc
Gate-Source Voltage	V_{GS}	-0.5, +15	Vdc
Total Device Dissipation @ $T_C = 25^\circ\text{C}$ Derate above 25 $^\circ\text{C}$	P_D	180 0.98	W W/ $^\circ\text{C}$
Storage Temperature Range	T_{stg}	- 65 to +150	$^\circ\text{C}$
Case Operating Temperature	T_C	150	$^\circ\text{C}$
Operating Junction Temperature	T_J	200	$^\circ\text{C}$

Table 2. Thermal Characteristics

Characteristic	Symbol	Value	Unit
Thermal Resistance, Junction to Case	$R_{\theta JC}$	1.02	$^\circ\text{C}/\text{W}$

Table 3. ESD Protection Characteristics

Test Conditions	Class
Human Body Model	2 (Minimum)
Machine Model	M3 (Minimum)

Table 4. Electrical Characteristics ($T_C = 25^\circ\text{C}$ unless otherwise noted)

Characteristic	Symbol	Min	Typ	Max	Unit
Off Characteristics					
Drain-Source Breakdown Voltage ($V_{GS} = 0\text{ Vdc}$, $I_D = 10\ \mu\text{Adc}$)	$V_{(BR)DSS}$	65	—	—	Vdc
Zero Gate Voltage Drain Current ($V_{DS} = 28\text{ Vdc}$, $V_{GS} = 0\text{ Vdc}$)	I_{DSS}	—	—	6	μAdc
Gate-Source Leakage Current ($V_{GS} = 5\text{ Vdc}$, $V_{DS} = 0\text{ Vdc}$)	I_{GSS}	—	—	1	μAdc
On Characteristics					
Gate Threshold Voltage ($V_{DS} = 10\text{ Vdc}$, $I_D = 300\ \mu\text{Adc}$)	$V_{GS(th)}$	2	—	4	Vdc
Gate Quiescent Voltage ($V_{DS} = 28\text{ Vdc}$, $I_D = 500\text{ mAdc}$)	$V_{GS(Q)}$	2.5	3.9	4.5	Vdc
Drain-Source On-Voltage ($V_{GS} = 10\text{ Vdc}$, $I_D = 2\text{ Adc}$)	$V_{DS(on)}$	—	0.27	—	Vdc
Dynamic Characteristics					
Reverse Transfer Capacitance (1) ($V_{DS} = 28\text{ Vdc}$, $V_{GS} = 0$, $f = 1\text{ MHz}$)	C_{rss}	—	2.7	—	pF
Functional Tests (In Freescale Test Fixture, 50 ohm system)					
Two-Tone Common-Source Amplifier Power Gain ($V_{DD} = 28\text{ Vdc}$, $P_{out} = 60\text{ W PEP}$, $I_{DQ} = 500\text{ mA}$, $f = 2110\text{ MHz}$ and 2170 MHz , Tone Spacing = 100 kHz)	G_{ps}	11	12.5	—	dB
Two-Tone Drain Efficiency ($V_{DD} = 28\text{ Vdc}$, $P_{out} = 60\text{ W PEP}$, $I_{DQ} = 500\text{ mA}$, $f = 2110\text{ MHz}$ and 2170 MHz , Tone Spacing = 100 kHz)	η	31	34	—	%
3rd Order Intermodulation Distortion ($V_{DD} = 28\text{ Vdc}$, $P_{out} = 60\text{ W PEP}$, $I_{DQ} = 500\text{ mA}$, $f = 2110\text{ MHz}$ and 2170 MHz , Tone Spacing = 100 kHz)	IMD	—	-30	-28	dBc
Input Return Loss ($V_{DD} = 28\text{ Vdc}$, $P_{out} = 60\text{ W PEP}$, $I_{DQ} = 500\text{ mA}$, $f = 2110\text{ MHz}$ and 2170 MHz , Tone Spacing = 100 kHz)	IRL	—	-12	—	dB
P_{out} 1 dB Compression Point ($V_{DD} = 28\text{ Vdc}$, $P_{out} = 60\text{ W CW}$, $f = 2170\text{ MHz}$)	P1dB	—	60	—	W

1. Part is internally matched both on input and output.

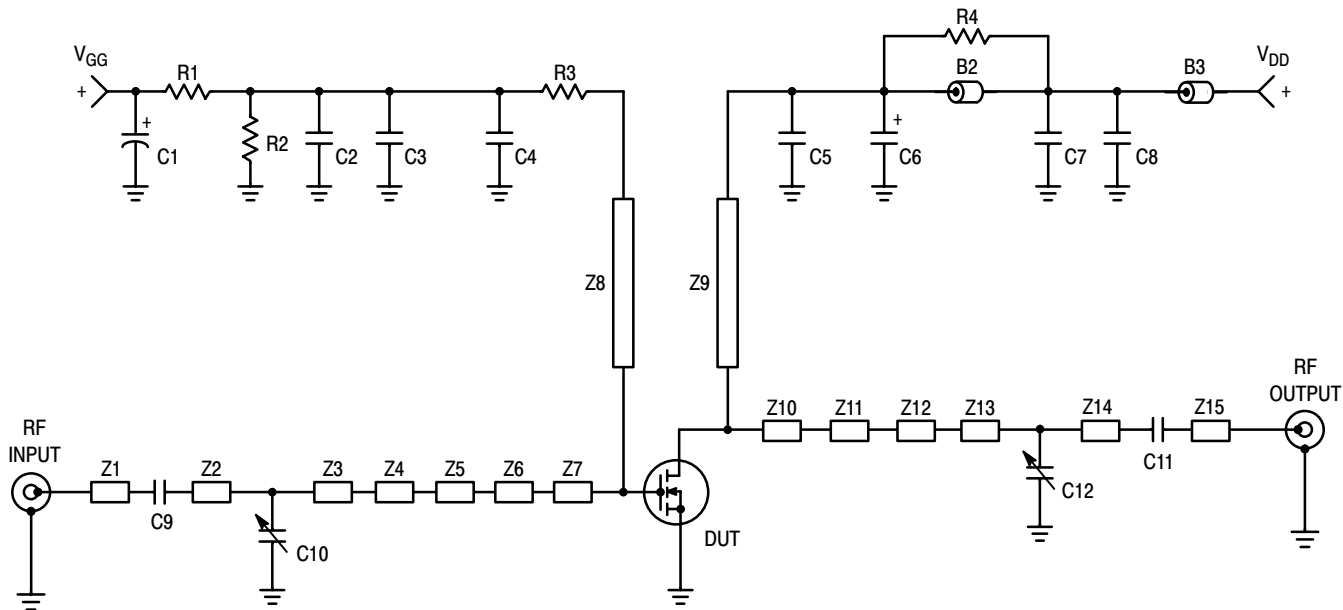

B2 - B3	Ferrite Beads, Fair Rite #2743019447	Z3	0.180" x 0.100" Microstrip
C1	10 μ F, 50 V Electrolytic Chip Capacitor, Panasonic #ECEV1HV100R	Z4	0.152" x 0.293" Microstrip
C2, C7	1000 pF Chip Capacitors, ATC #100B102JCA500X	Z5	0.216" x 0.100" Microstrip
C3, C8	0.10 μ F Chip Capacitors, Kemet #CDR33BX104AKWS	Z6	0.114" x 0.410" Microstrip
C4, C5	4.7 pF Chip Capacitors, ATC #100B4R7JCA500X	Z7	0.626" x 0.872" Microstrip
C6	22 μ F, 35 V Tantalum Surface Mount Chip Capacitor, Sprague	Z8	1.050" x 0.050" Microstrip
C9, C11	9.1 pF Chip Capacitors, ATC #100B9R1JCA500X	Z9	0.830" x 0.050" Microstrip
C10	0.8 pF - 8.0 pF Variable Capacitor, Johanson Gigatrim	Z10	0.596" x 1.040" Microstrip
C12	0.4 pF - 4.5 pF Variable Capacitor, Johanson Gigatrim	Z11	0.186" x 0.315" Microstrip
R1	1 k Ω , 1/4 W Fixed Film Chip Resistor, 0.08" x 0.13"	Z12	0.097" x 0.525" Microstrip
R2	560 k Ω , 1/4 W Fixed Film Chip Resistor, 0.08" x 0.13"	Z13	0.353" x 0.138" Microstrip
R3	10 Ω , 1/4 W Fixed Film Chip Resistor, 0.08" x 0.13"	Z14	0.112" x 0.080" Microstrip
R4	10 Ω , 1/4 W Fixed Film Chip Resistor, 0.08" x 0.13"	Z15	0.722" x 0.080" Microstrip
Z1	0.743" x 0.080" Microstrip	Board	0.030" Glass Teflon [®] , Arlon GX-0300-55-22, 2 oz Cu
Z2	0.070" x 0.100" Microstrip		

Figure 1. MRF21060L Test Circuit Schematic

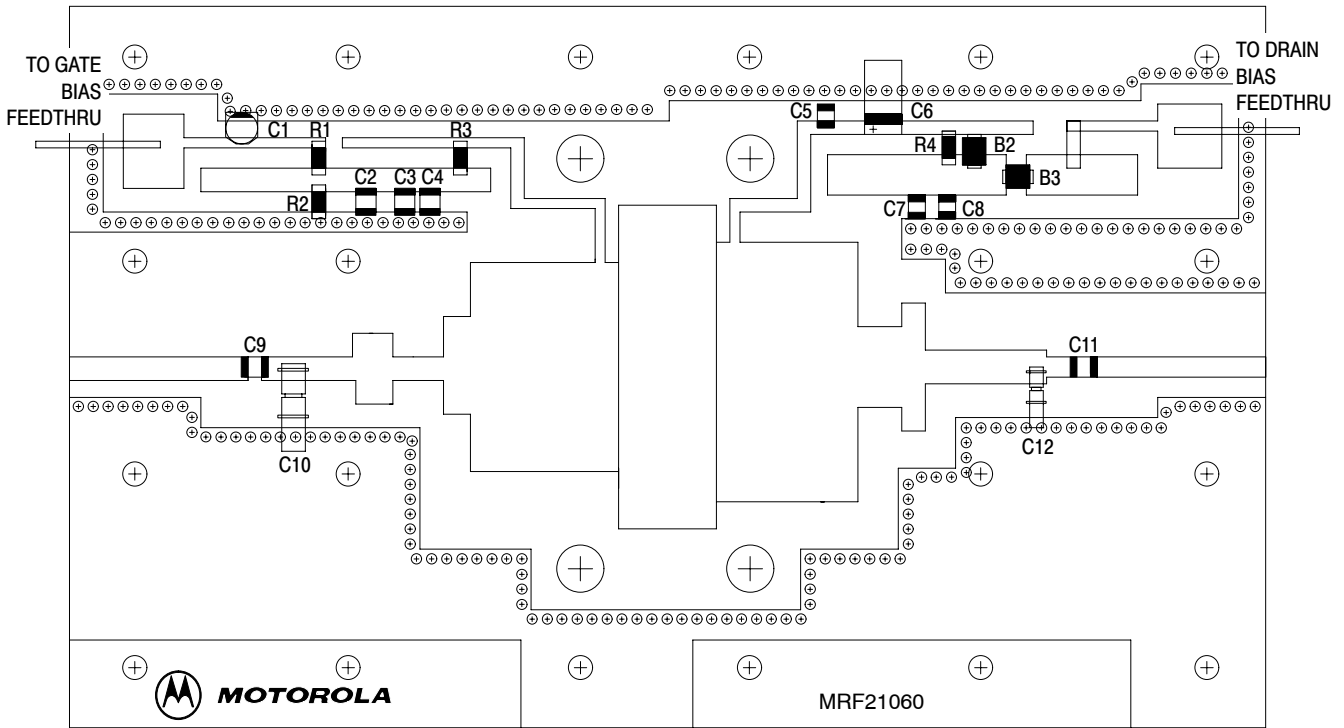

Freescall has begun the transition of marking Printed Circuit Boards (PCBs) with the Freescall Semiconductor signature/logo. PCBs may have either Motorola or Freescall markings during the transition period. These changes will have no impact on form, fit or function of the current product.

Figure 2. MRF21060L Test Circuit Component Layout

TYPICAL CHARACTERISTICS

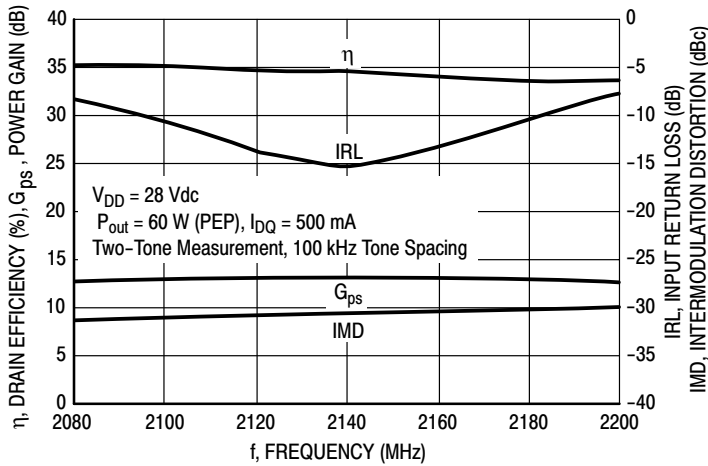

Figure 3. Class AB Broadband Circuit Performance

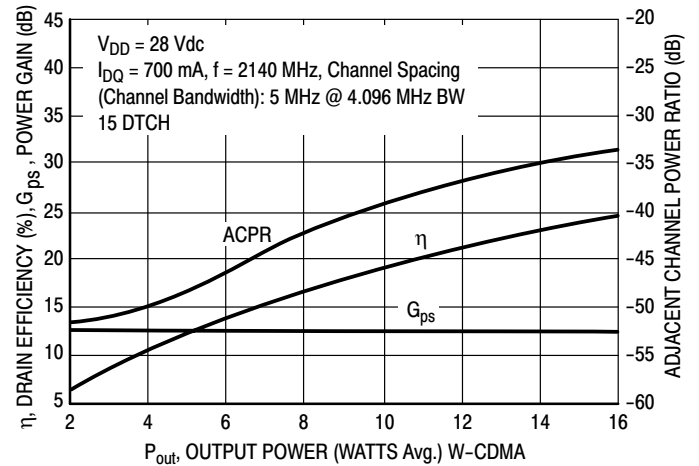

Figure 4. W-CDMA ACPR, Power Gain and Drain Efficiency versus Output Power

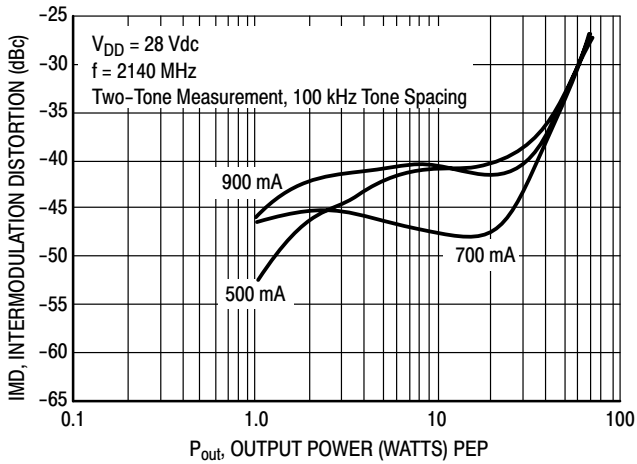

Figure 5. Intermodulation Distortion versus Output Power

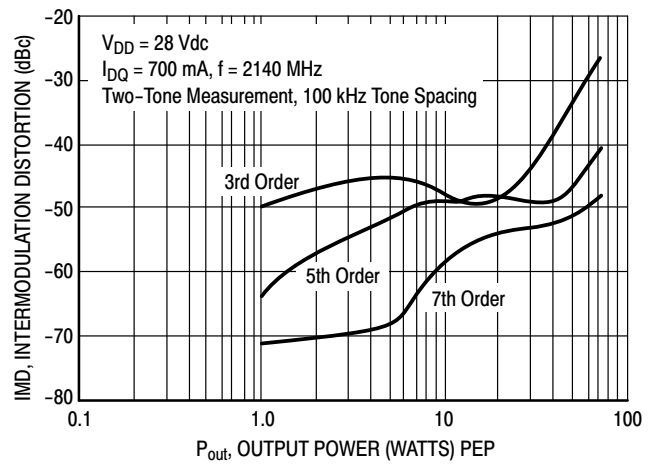

Figure 6. Intermodulation Distortion Products versus Output Power

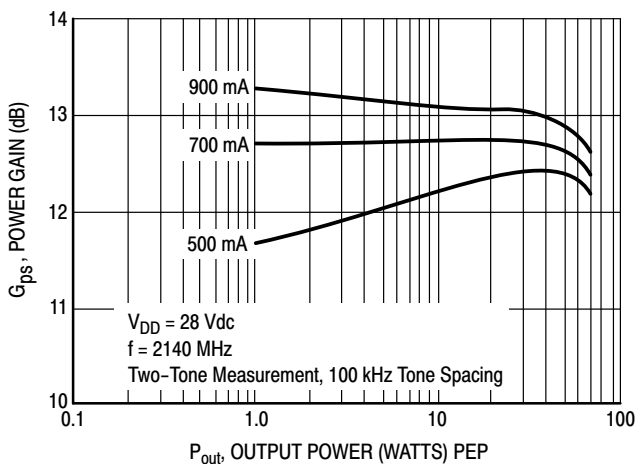

Figure 7. Power Gain versus Output Power

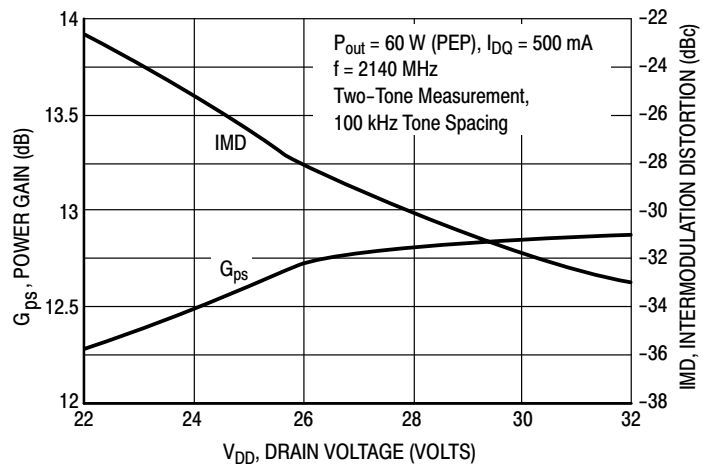
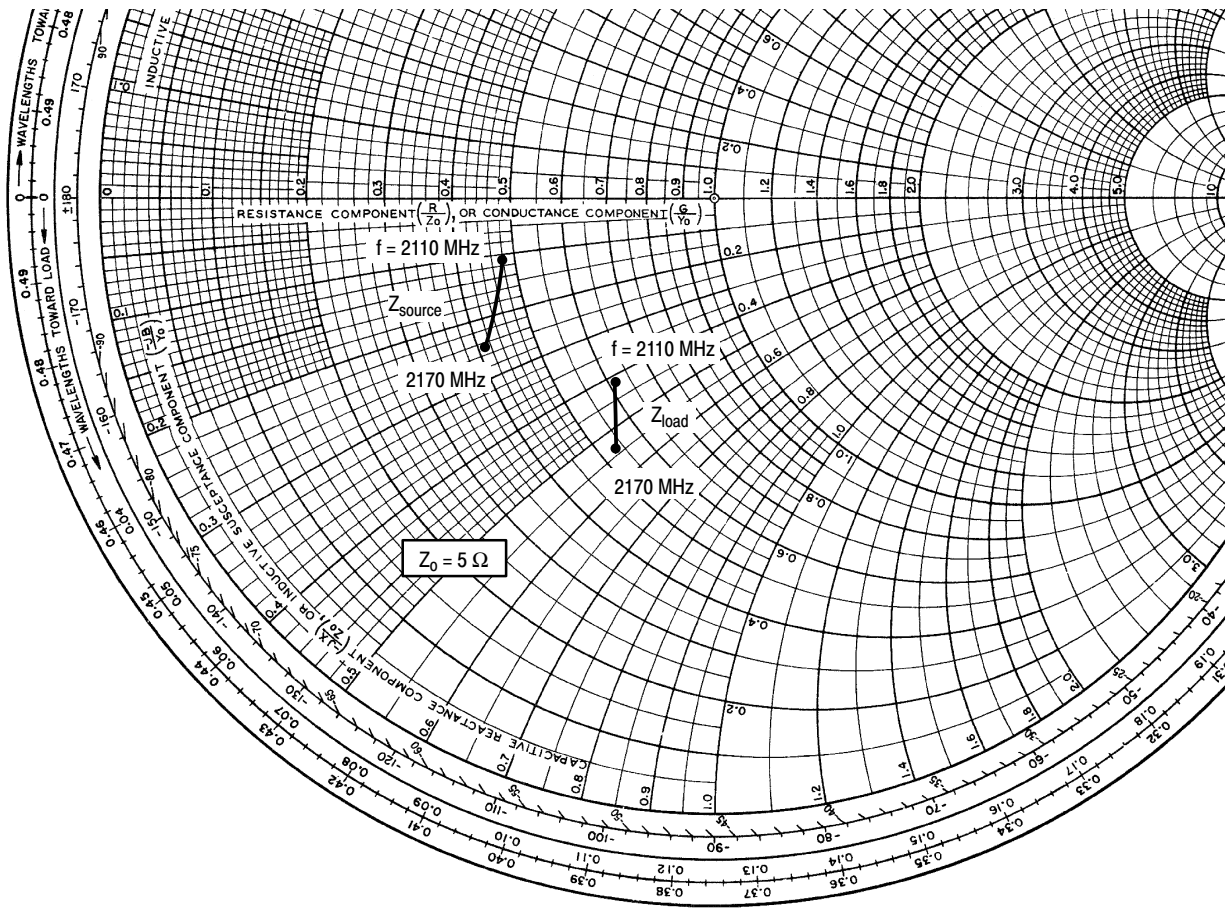

Figure 8. Power Gain and Intermodulation Distortion versus Supply Voltage



$V_{DD} = 28\text{ V}$, $I_{DQ} = 500\text{ mA}$, $P_{out} = 60\text{ W PEP}$

f MHz	Z_{source} Ω	Z_{load} Ω
2110	$2.40 - j0.55$	$3.07 - j2.05$
2140	$2.26 - j0.87$	$2.89 - j2.38$
2170	$2.08 - j1.23$	$2.66 - j2.71$

Z_{source} = Test circuit impedance as measured from gate to ground.

Z_{load} = Test circuit impedance as measured from drain to ground.

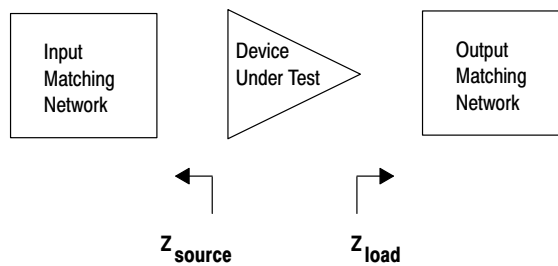
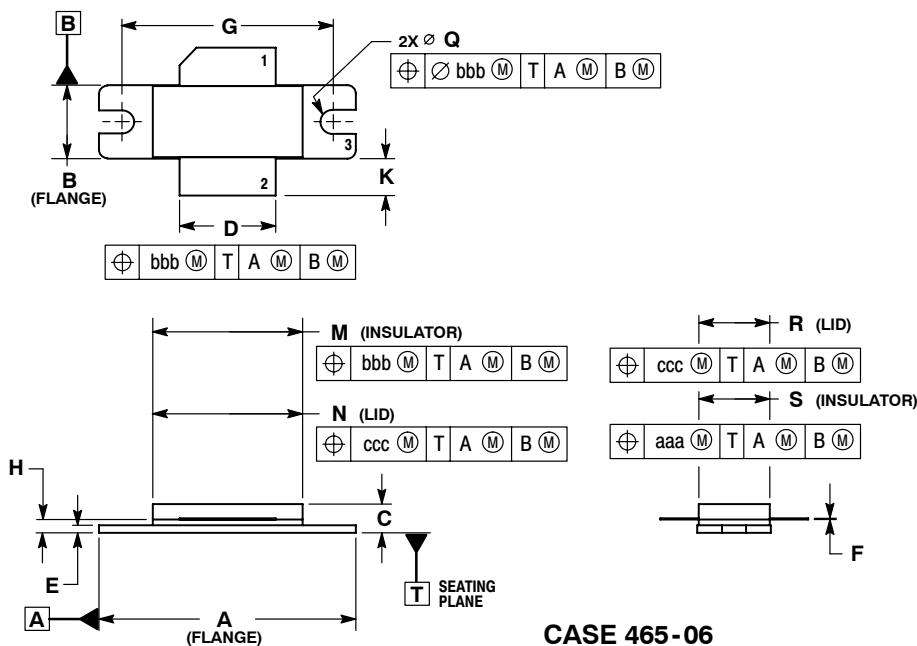
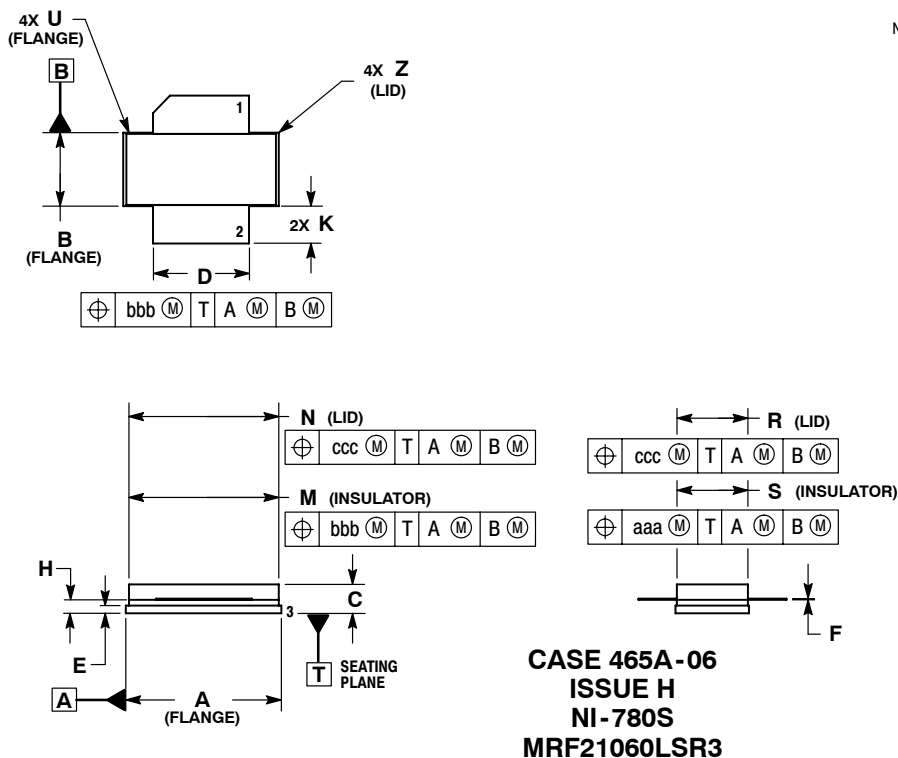

Figure 9. Series Equivalent Source and Load Impedance

PACKAGE DIMENSIONS



**CASE 465-06
 ISSUE G
 NI-780
 MRF2106LR3**



**CASE 465A-06
 ISSUE H
 NI-780S
 MRF2106LSR3**

How to Reach Us:

Home Page:

www.freescale.com

E-mail:

support@freescale.com

USA/Europe or Locations Not Listed:

Freescale Semiconductor
Technical Information Center, CH370
1300 N. Alma School Road
Chandler, Arizona 85224
+1-800-521-6274 or +1-480-768-2130
support@freescale.com

Europe, Middle East, and Africa:

Freescale Halbleiter Deutschland GmbH
Technical Information Center
Schatzbogen 7
81829 Muenchen, Germany
+44 1296 380 456 (English)
+46 8 52200080 (English)
+49 89 92103 559 (German)
+33 1 69 35 48 48 (French)
support@freescale.com

Japan:

Freescale Semiconductor Japan Ltd.
Headquarters
ARCO Tower 15F
1-8-1, Shimo-Meguro, Meguro-ku,
Tokyo 153-0064
Japan
0120 191014 or +81 3 5437 9125
support.japan@freescale.com

Asia/Pacific:

Freescale Semiconductor Hong Kong Ltd.
Technical Information Center
2 Dai King Street
Tai Po Industrial Estate
Tai Po, N.T., Hong Kong
+800 2666 8080
support.asia@freescale.com

For Literature Requests Only:

Freescale Semiconductor Literature Distribution Center
P.O. Box 5405
Denver, Colorado 80217
1-800-441-2447 or 303-675-2140
Fax: 303-675-2150
LDCForFreescaleSemiconductor@hibbertgroup.com

Information in this document is provided solely to enable system and software implementers to use Freescale Semiconductor products. There are no express or implied copyright licenses granted hereunder to design or fabricate any integrated circuits or integrated circuits based on the information in this document.

Freescale Semiconductor reserves the right to make changes without further notice to any products herein. Freescale Semiconductor makes no warranty, representation or guarantee regarding the suitability of its products for any particular purpose, nor does Freescale Semiconductor assume any liability arising out of the application or use of any product or circuit, and specifically disclaims any and all liability, including without limitation consequential or incidental damages. "Typical" parameters that may be provided in Freescale Semiconductor data sheets and/or specifications can and do vary in different applications and actual performance may vary over time. All operating parameters, including "Typicals", must be validated for each customer application by customer's technical experts. Freescale Semiconductor does not convey any license under its patent rights nor the rights of others. Freescale Semiconductor products are not designed, intended, or authorized for use as components in systems intended for surgical implant into the body, or other applications intended to support or sustain life, or for any other application in which the failure of the Freescale Semiconductor product could create a situation where personal injury or death may occur. Should Buyer purchase or use Freescale Semiconductor products for any such unintended or unauthorized application, Buyer shall indemnify and hold Freescale Semiconductor and its officers, employees, subsidiaries, affiliates, and distributors harmless against all claims, costs, damages, and expenses, and reasonable attorney fees arising out of, directly or indirectly, any claim of personal injury or death associated with such unintended or unauthorized use, even if such claim alleges that Freescale Semiconductor was negligent regarding the design or manufacture of the part.

Freescale™ and the Freescale logo are trademarks of Freescale Semiconductor, Inc. All other product or service names are the property of their respective owners.

© Freescale Semiconductor, Inc. 2006. All rights reserved.

