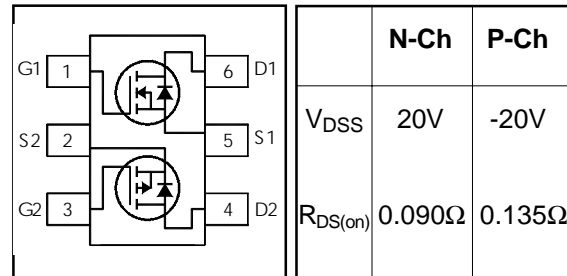


# IRF5851

HEXFET® Power MOSFET

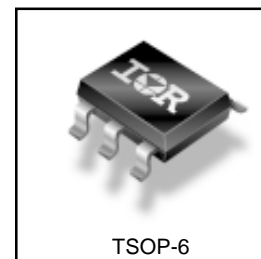
- Ultra Low On-Resistance
- Dual N and P Channel MOSFET
- Surface Mount
- Available in Tape & Reel
- Low Gate Charge



## Description

These N and P channel MOSFETs from International Rectifier utilize advanced processing techniques to achieve the extremely low on-resistance per silicon area. This benefit provides the designer with an extremely efficient device for use in battery and load management applications.

This Dual TSOP-6 package is ideal for applications where printed circuit board space is at a premium and where maximum functionality is required. With two die per package, the IRF5851 can provide the functionality of two SOT-23 packages in a smaller footprint. Its unique thermal design and  $R_{DS(on)}$  reduction enables an increase in current-handling capability.



## Absolute Maximum Ratings

	Parameter	Max.		Units
		N-Channel	P-Channel	
$V_{DS}$	Drain-to-Source Voltage	20	-20	A
$I_D @ T_A = 25^\circ\text{C}$	Continuous Drain Current, $V_{GS} @ 10\text{V}$	2.7	-2.2	
$I_D @ T_A = 70^\circ\text{C}$	Continuous Drain Current, $V_{GS} @ 10\text{V}$	2.2	-1.7	
$I_{DM}$	Pulsed Drain Current ①	11	-9.0	
$P_D @ T_A = 25^\circ\text{C}$	Power Dissipation ③	0.96		W
$P_D @ T_A = 70^\circ\text{C}$	Power Dissipation ③	0.62		
	Linear Derating Factor	7.7		mW/°C
$V_{GS}$	Gate-to-Source Voltage	$\pm 12$		V
$T_J, T_{STG}$	Junction and Storage Temperature Range	-55 to +150		°C

## Thermal Resistance

	Parameter	Typ.	Max.	Units
$R_{\theta JA}$	Maximum Junction-to-Ambient ③	—	130	°C/W

## Electrical Characteristics @ $T_J = 25^\circ\text{C}$ (unless otherwise specified)

Parameter	Description		Min.	Typ.	Max.	Units	Conditions
$V_{(BR)DSS}$	Drain-to-Source Breakdown Voltage		20	—	—	V	$V_{GS} = 0V, I_D = 250\mu A$ $V_{GS} = 0V, I_D = -250\mu A$
$\Delta V_{(BR)DSS}/\Delta T_J$	Breakdown Voltage Temp. Coefficient		—	0.016	—	V/°C	Reference to $25^\circ\text{C}, I_D = 1\text{mA}$ Reference to $25^\circ\text{C}, I_D = -1\text{mA}$
$R_{DS(ON)}$	Static Drain-to-Source On-Resistance	N-Ch	—	—	0.090	Ω	$V_{GS} = 4.5V, I_D = 2.7A$ ②
			—	—	0.120		$V_{GS} = 2.5V, I_D = 2.2A$ ②
		P-Ch	—	—	0.135		$V_{GS} = -4.5V, I_D = -2.2A$ ②
			—	—	0.220		$V_{GS} = -2.5V, I_D = -1.7A$ ②
$V_{GS(th)}$	Gate Threshold Voltage	N-Ch	0.60	—	1.25	V	$V_{DS} = V_{GS}, I_D = 250\mu A$ $V_{DS} = V_{GS}, I_D = -250\mu A$
		P-Ch	-0.45	—	-1.2		$V_{DS} = 10V, I_D = 2.7A$ ② $V_{DS} = -10V, I_D = -2.2A$ ②
$g_{fs}$	Forward Transconductance		5.2	—	—	S	$V_{DS} = 16V, V_{GS} = 0V$ $V_{DS} = -16V, V_{GS} = 0V$
$I_{DSS}$	Drain-to-Source Leakage Current	N-Ch	—	—	1.0	μA	$V_{DS} = 16V, V_{GS} = 0V$
		P-Ch	—	—	-1.0		$V_{DS} = -16V, V_{GS} = 0V$
		N-Ch	—	—	25		$V_{DS} = 16V, V_{GS} = 0V, T_J = 70^\circ\text{C}$
		P-Ch	—	—	-25		$V_{DS} = -16V, V_{GS} = 0V, T_J = 70^\circ\text{C}$
$I_{GSS}$	Gate-to-Source Forward Leakage	N-P	—	—	±100		$V_{GS} = \pm 12V$
$Q_g$	Total Gate Charge	N-Ch	—	4.0	6.0		N-Channel $I_D = 2.7A, V_{DS} = 10V, V_{GS} = 4.5V$
		P-Ch	—	3.6	5.4		
$Q_{gs}$	Gate-to-Source Charge	N-Ch	—	0.95	—	nC	P-Channel $I_D = -2.2A, V_{DS} = -10V, V_{GS} = -4.5V$
		P-Ch	—	0.66	—		
$Q_{gd}$	Gate-to-Drain ("Miller") Charge	N-Ch	—	0.83	—		N-Channel $V_{DD} = 10V, I_D = 1.0A, R_G = 6.2\Omega, V_{GS} = 4.5V$
		P-Ch	—	5.7	—		
$t_{d(on)}$	Turn-On Delay Time		—	6.6	—	ns	P-Channel $V_{DD} = -10V, I_D = -1.0A, R_G = 6.0\Omega, V_{GS} = -4.5V$
$t_r$	Rise Time		—	1.2	—		
$t_{d(off)}$	Turn-Off Delay Time		—	15	—		N-Channel $V_{DD} = 10V, I_D = 1.0A, R_G = 6.2\Omega, V_{GS} = 4.5V$
$t_f$	Fall Time		—	2.4	—		
$C_{iss}$	Input Capacitance	N-Ch	—	400	—	pF	N-Channel $V_{GS} = 0V, V_{DS} = 15V, f = 1.0\text{MHz}$
		P-Ch	—	320	—		
$C_{oss}$	Output Capacitance	N-Ch	—	48	—		P-Channel $V_{GS} = 0V, V_{DS} = -15V, f = 1.0\text{MHz}$
		P-Ch	—	56	—		
$C_{rss}$	Reverse Transfer Capacitance		—	32	—		
			—	40	—		

## Source-Drain Ratings and Characteristics

Parameter	Description		Min.	Typ.	Max.	Units	Conditions
$I_S$	Continuous Source Current (Body Diode)	N-Ch	—	—	0.96	A	
		P-Ch	—	—	-0.96		
$I_{SM}$	Pulsed Source Current (Body Diode) ①	N-Ch	—	—	11		
		P-Ch	—	—	-9.0		
$V_{SD}$	Diode Forward Voltage	N-Ch	—	—	1.2	V	$T_J = 25^\circ\text{C}, I_S = 0.96A, V_{GS} = 0V$ ②
		P-Ch	—	—	-1.2		$T_J = 25^\circ\text{C}, I_S = -0.96A, V_{GS} = 0V$ ②
$t_{rr}$	Reverse Recovery Time	N-Ch	—	25	38	ns	N-Channel $T_J = 25^\circ\text{C}, I_F = 0.96A, di/dt = 100A/\mu s$
		P-Ch	—	23	35		
$Q_{rr}$	Reverse Recovery Charge	N-Ch	—	6.5	9.8	nC	P-Channel $T_J = 25^\circ\text{C}, I_F = -0.96A, di/dt = -100A/\mu s$ ②
		P-Ch	—	7.7	12		

### Notes:

- ① Repetitive rating; pulse width limited by max. junction temperature. ( See fig. 10 & 26 )  
 ② Pulse width  $\leq 400\mu s$ ; duty cycle  $\leq 2\%$ .

- ③ Surface mounted on FR-4 board,  $t \leq 10\text{sec}$ .

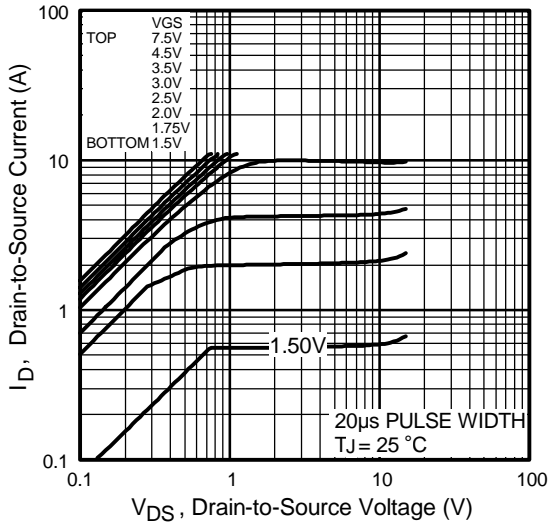


Fig 1. Typical Output Characteristics

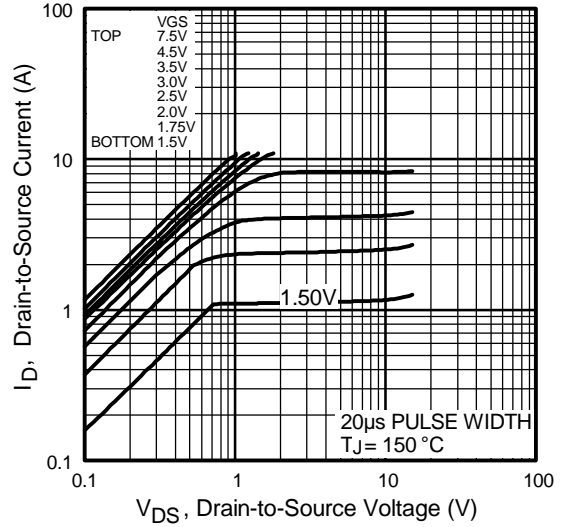


Fig 2. Typical Output Characteristics

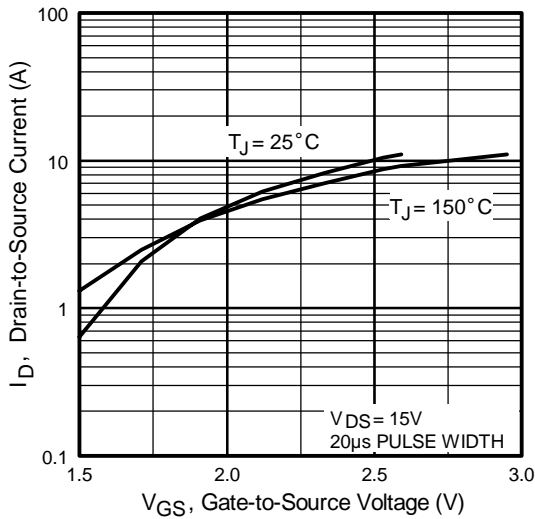


Fig 3. Typical Transfer Characteristics

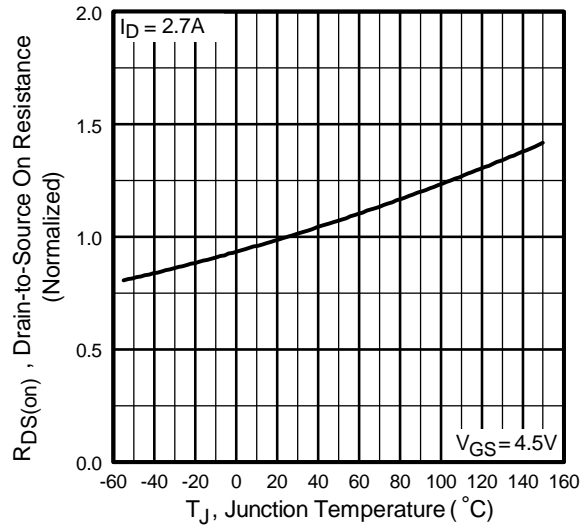
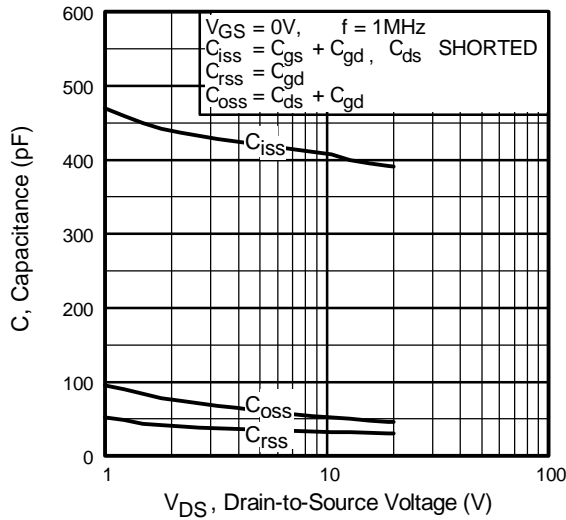
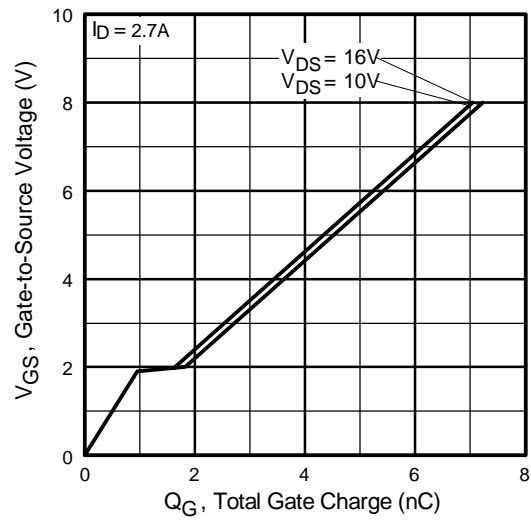


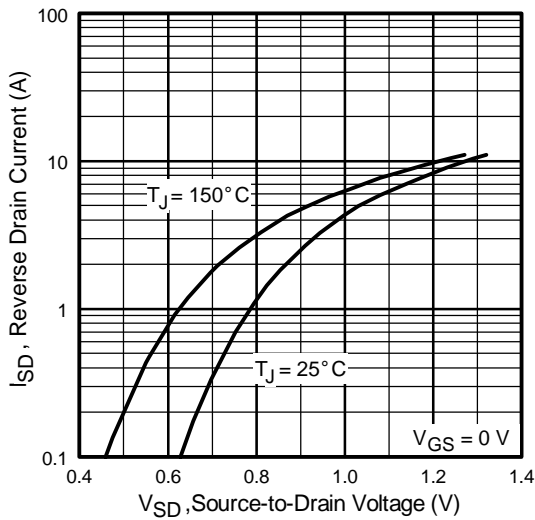
Fig 4. Normalized On-Resistance Vs. Temperature



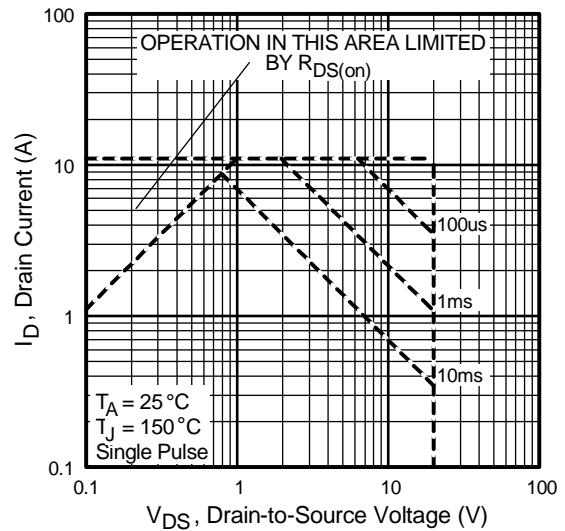
**Fig 5.** Typical Capacitance Vs. Drain-to-Source Voltage



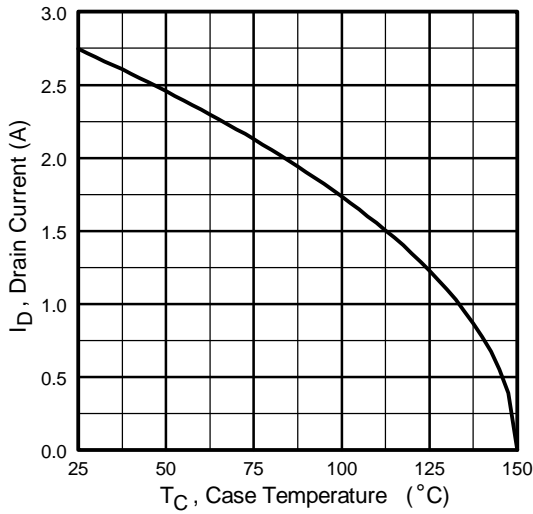
**Fig 6.** Typical Gate Charge Vs. Gate-to-Source Voltage



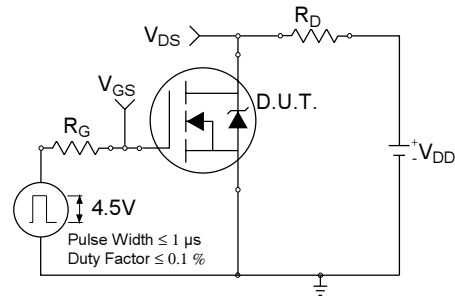
**Fig 7.** Typical Source-Drain Diode Forward Voltage



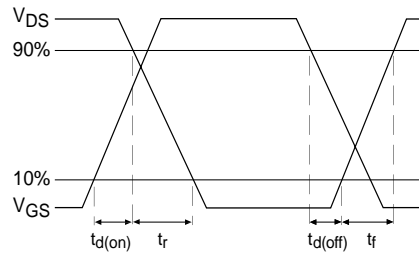
**Fig 8.** Maximum Safe Operating Area



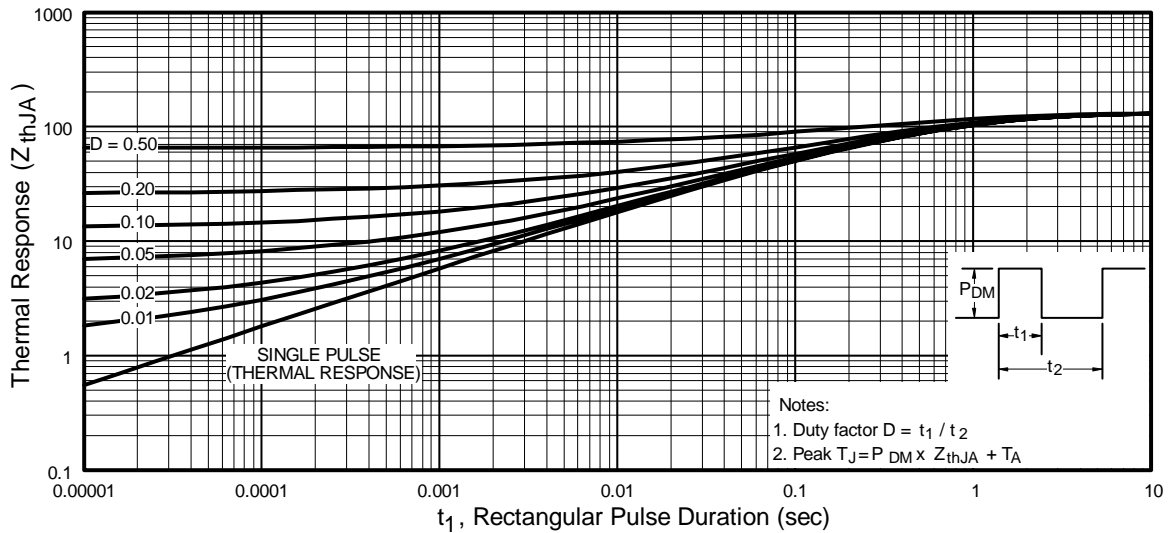
**Fig 9.** Maximum Drain Current Vs. Case Temperature



**Fig 10a.** Switching Time Test Circuit



**Fig 10b.** Switching Time Waveforms

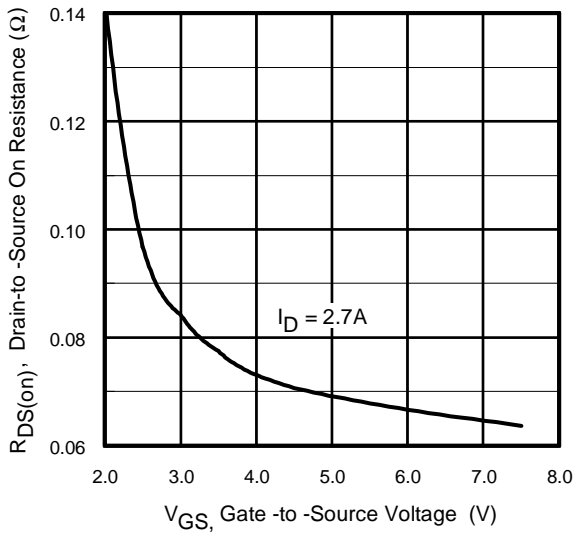


**Fig 10.** Typical Effective Transient Thermal Impedance, Junction-to-Ambient

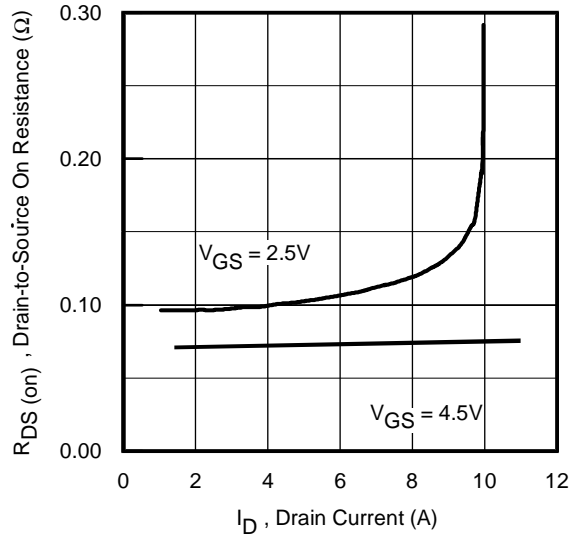
# IRF5851

N-Channel

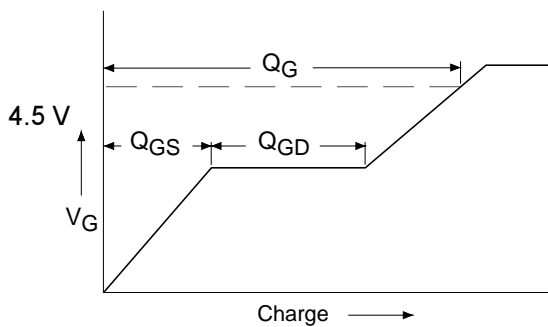
International  
**IR** Rectifier



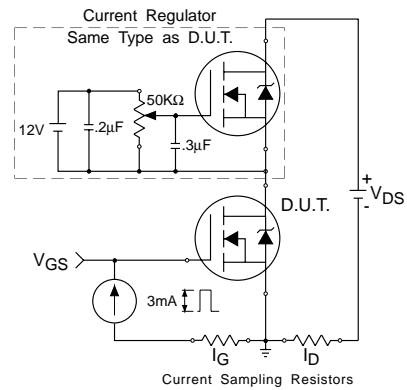
**Fig 11.** Typical On-Resistance Vs. Gate Voltage



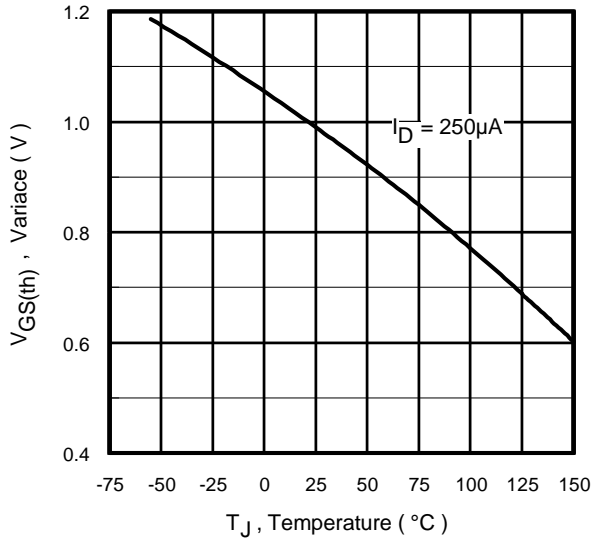
**Fig 12.** Typical On-Resistance Vs. Drain Current



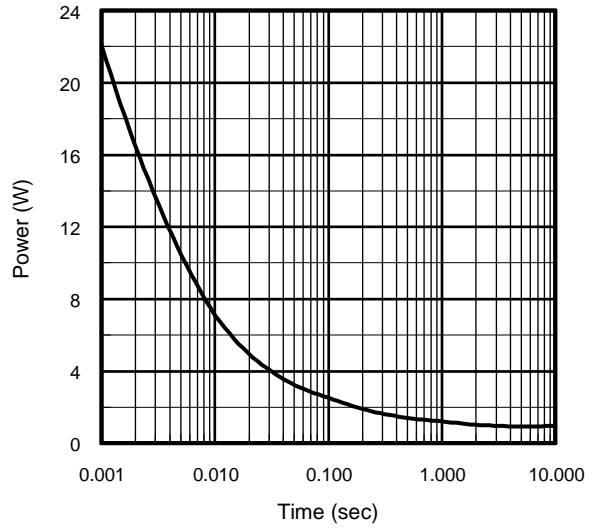
**Fig 13a.** Basic Gate Charge Waveform



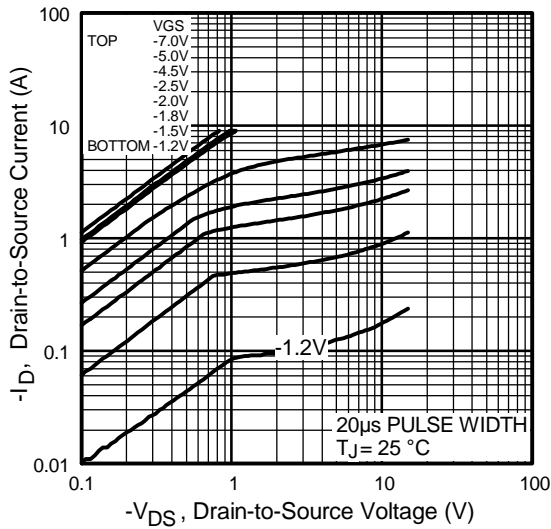
**Fig 13b.** Gate Charge Test Circuit



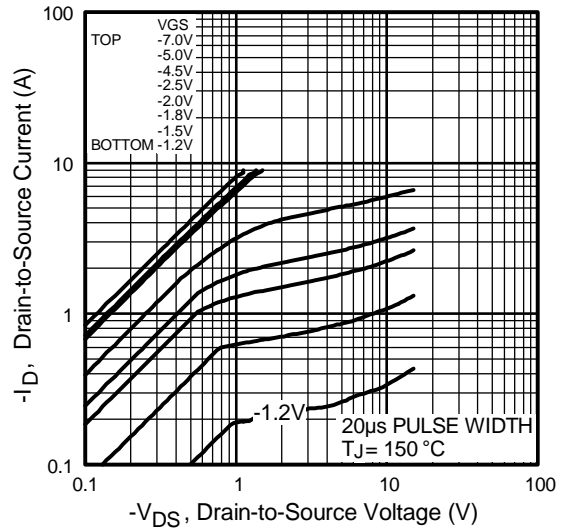
**Fig 14.** Threshold Voltage Vs. Temperature



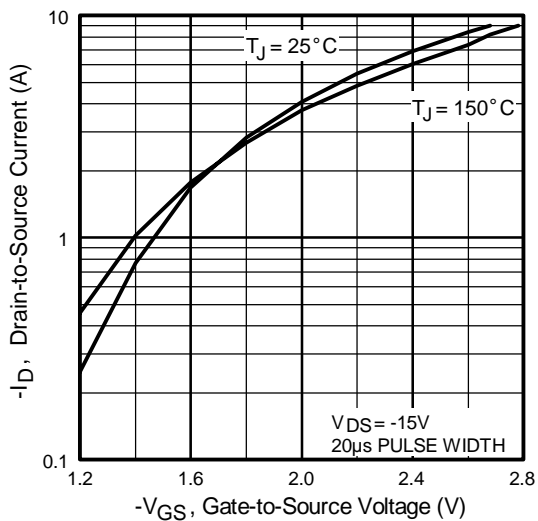
**Fig 15.** Typical Power Vs. Time



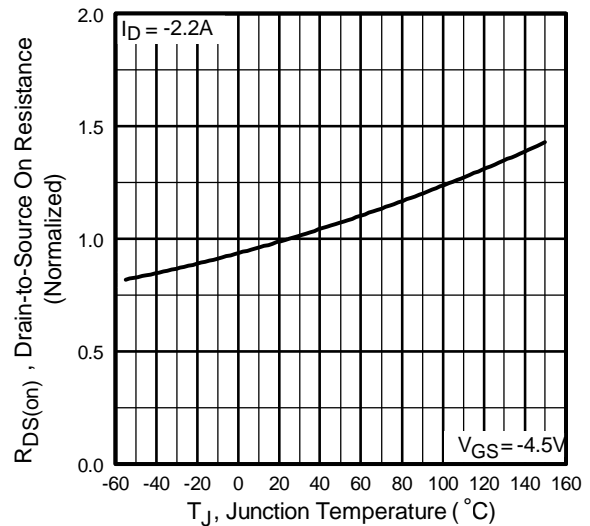
**Fig 16.** Typical Output Characteristics



**Fig 17.** Typical Output Characteristics



**Fig 18.** Typical Transfer Characteristics



**Fig 19.** Normalized On-Resistance Vs. Temperature



P-Channel

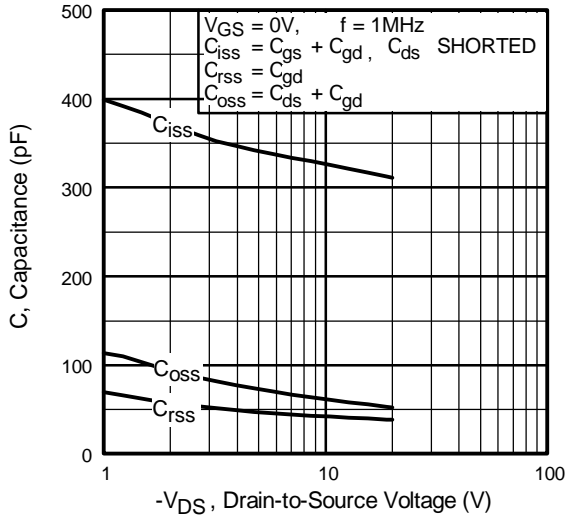


Fig 20. Typical Capacitance Vs. Drain-to-Source Voltage

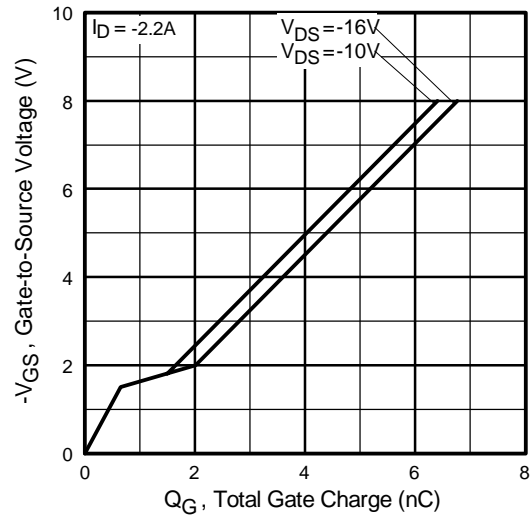


Fig 21. Typical Gate Charge Vs. Gate-to-Source Voltage

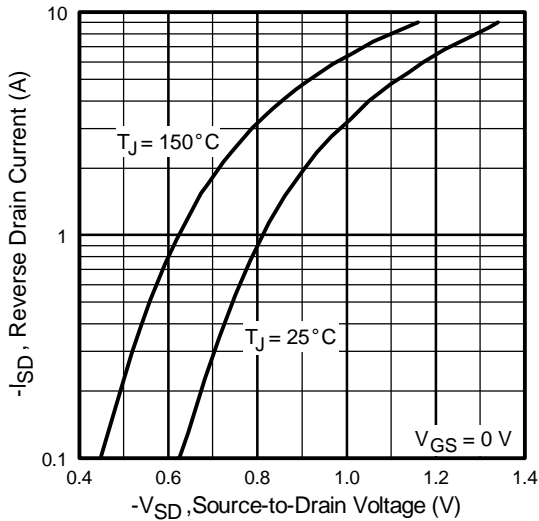


Fig 22. Typical Source-Drain Diode Forward Voltage

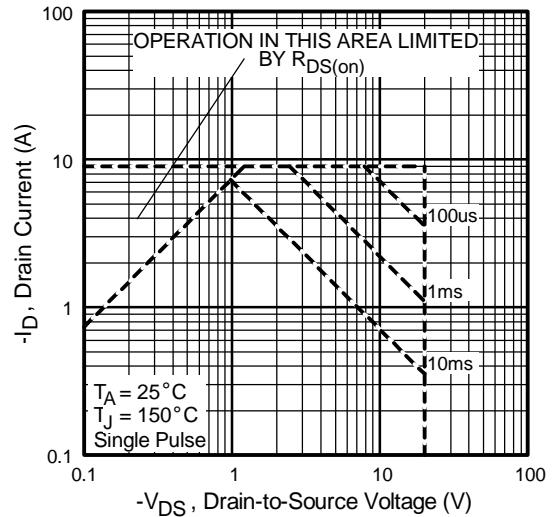
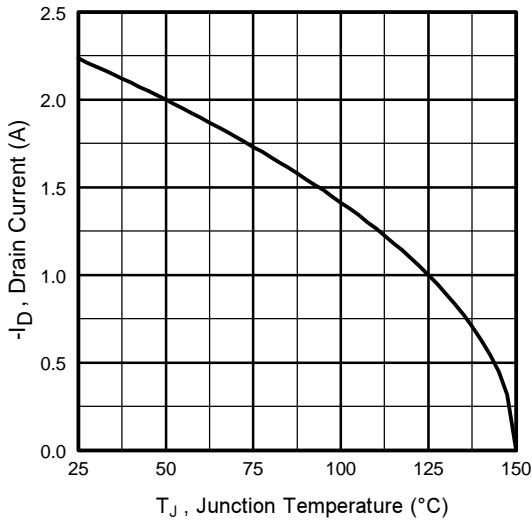


Fig 23. Maximum Safe Operating Area

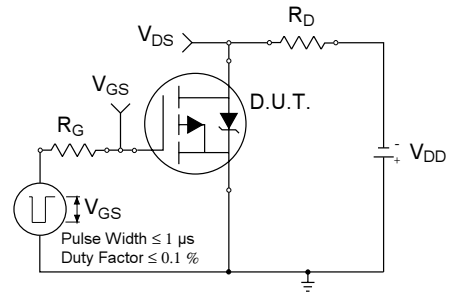
# IRF5851

P-Channel

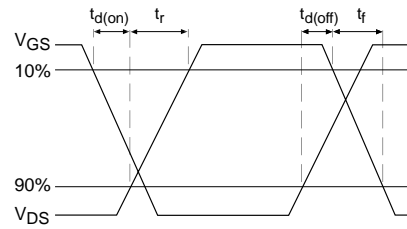
International  
**IRF** Rectifier



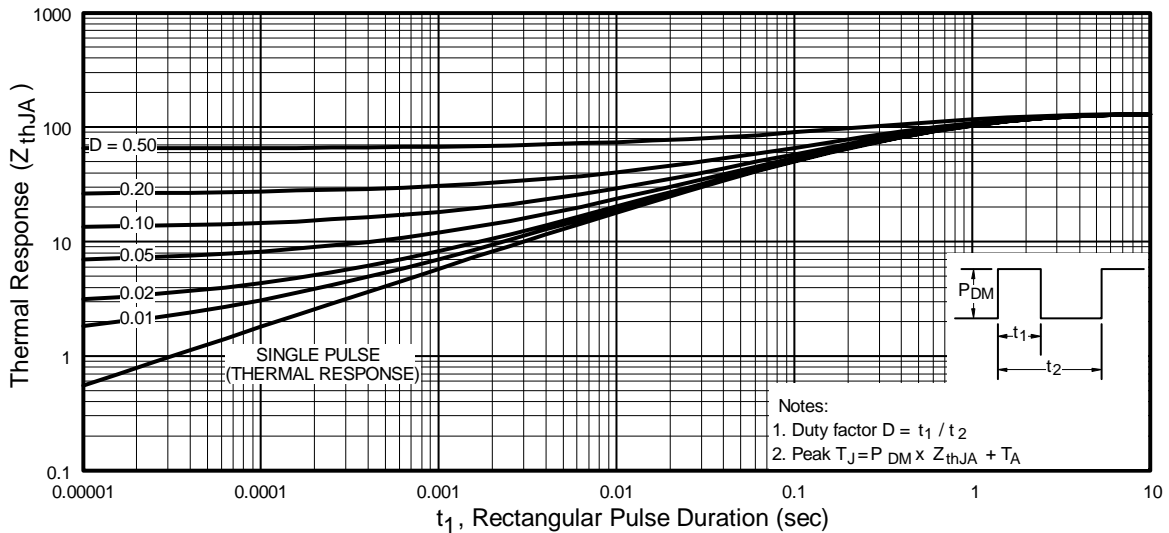
**Fig 24.** Maximum Drain Current Vs. Junction Temperature



**Fig 25a.** Switching Time Test Circuit



**Fig 25b.** Switching Time Waveforms



**Fig 26.** Typical Effective Transient Thermal Impedance, Junction-to-Ambient

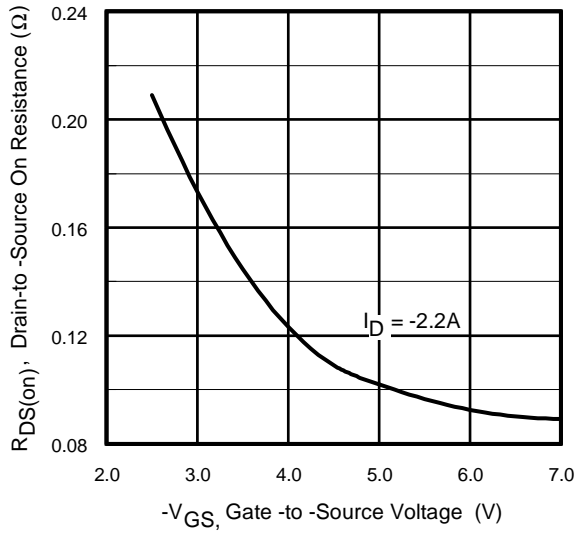


Fig 27. Typical On-Resistance Vs. Gate Voltage

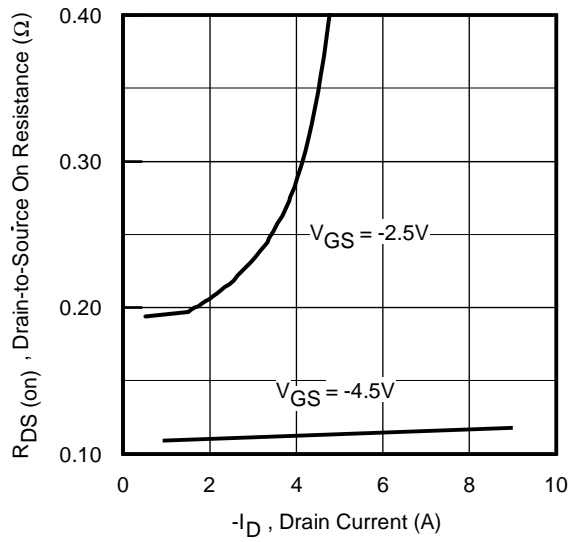


Fig 28. Typical On-Resistance Vs. Drain Current

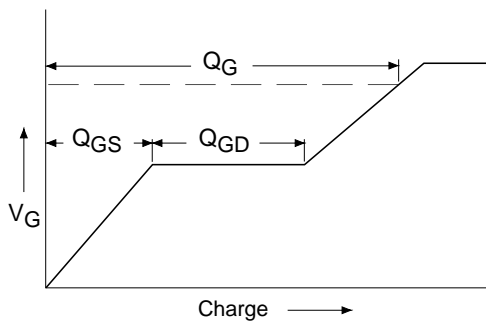


Fig 29a. Basic Gate Charge Waveform

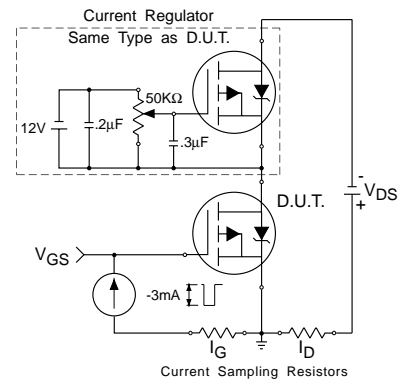
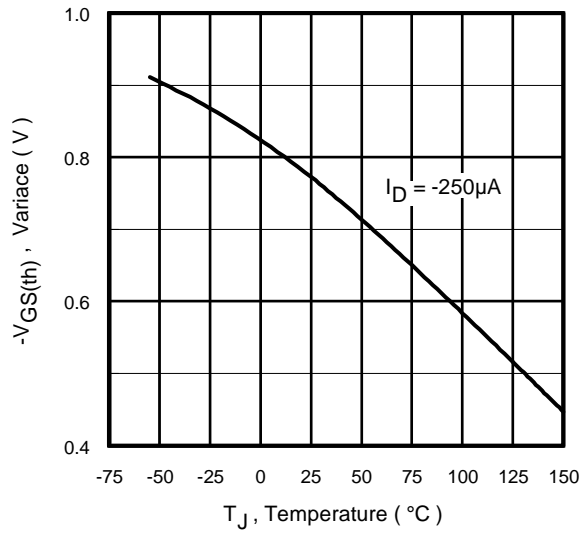


Fig 29b. Gate Charge Test Circuit

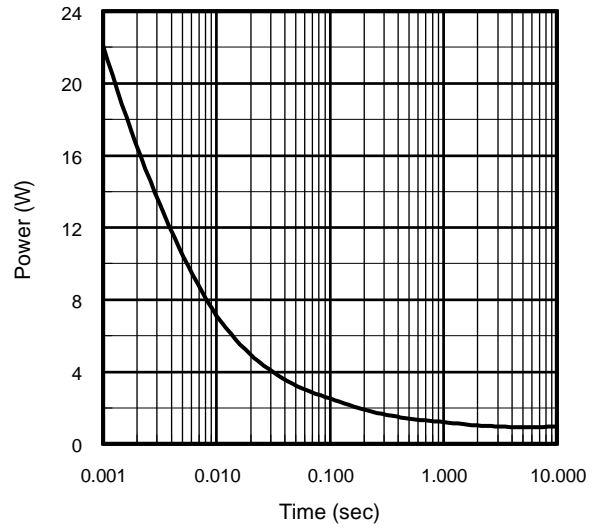
# IRF5851

P-Channel

International  
**IR** Rectifier

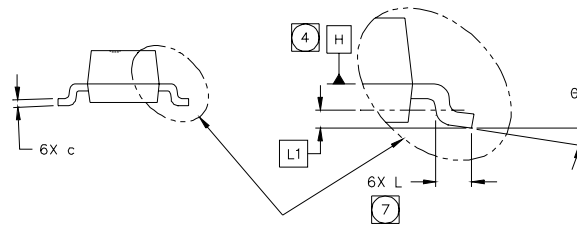
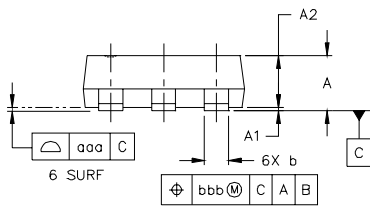
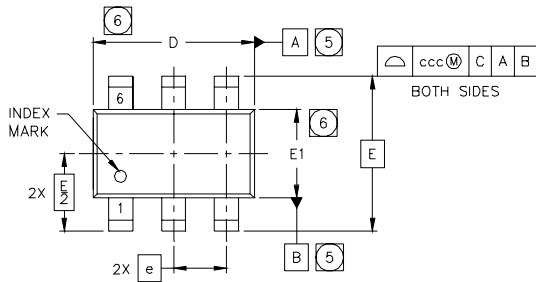


**Fig 30.** Threshold Voltage Vs. Temperature



**Fig 31.** Typical Power Vs. Time

## TSOP-6 Package Outline

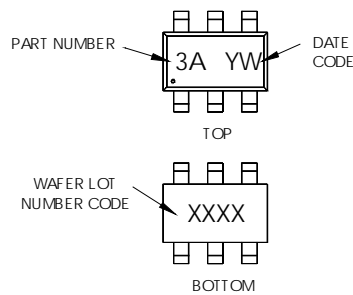


SYMBOL	MO-193AA DIMENSIONS					
	MILLIMETERS			INCHES		
	MIN	NOM	MAX	MIN	NOM	MAX
A	---	---	1.10	---	---	.0433
A1	0.01	---	0.10	.0004	---	.0039
A2	0.80	0.90	1.00	.0315	.0354	.0393
b	0.25	---	0.50	.0099	---	.0196
c	0.10	---	0.26	.004	---	.010
D	2.90	3.00	3.10	.115	.118	.122
E	2.75 BSC			.108 BSC		
E1	1.30	1.50	1.70	.052	.059	.066
e	1.00 BSC			.039 BSC		
L	0.20	0.40	0.60	.0079	.0157	.0236
L1	0.30 BSC			.0118 BSC		
θ	0°	---	8°	0°	---	8°
aaa	0.10			.004		
bbb	0.15			.006		
ccc	0.25			.010		

## TSOP-6 Part Marking Information

EXAMPLE: THIS IS AN SI3443DV

WW = (1-26) IF PRECEDED BY LAST DIGIT OF CALENDAR YEAR



YEAR	Y	WORK WEEK	W
2001	1	01	A
2002	2	02	B
2003	3	03	C
2004	4	04	D
2005	5		
1996	6		
1997	7		
1998	8		
1999	9		
2000	0	24	X
		25	Y
		26	Z

PART NUMBER CODE REFERENCE:

- 3A = SI3443DV
- 3B = IRF5800
- 3C = IRF5850
- 3D = IRF5851
- 3E = IRF5852
- 3I = IRF5805
- 3J = IRF5806

DATE CODE EXAMPLES:

- YWW = 9603 = 6C
- YWW = 9632 = FF

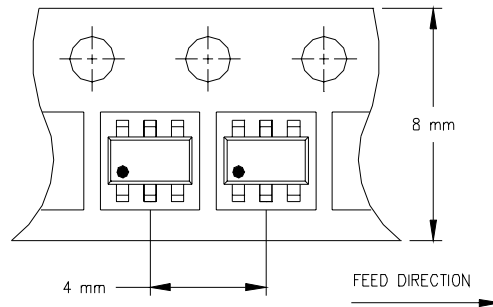
WW = (27-52) IF PRECEDED BY A LETTER

YEAR	Y	WORK WEEK	W
2001	A	27	A
2002	B	28	B
2003	C	29	C
2004	D	30	D
2005	E		
1996	F		
1997	G		
1998	H		
1999	J		
2000	K	50	X
		51	Y
		52	Z

# IRF5851

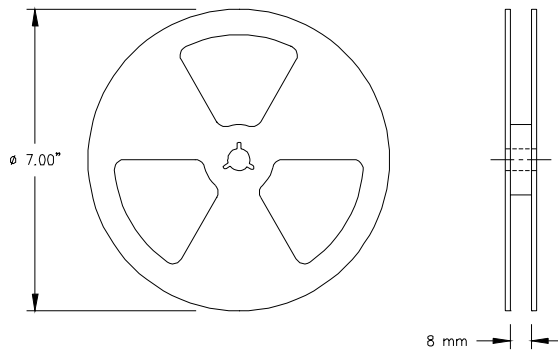
International  
**IR** Rectifier

## TSOP-6 Tape & Reel Information



NOTES:

1. OUTLINE CONFORMS TO EIA-481 & EIA-541.



NOTES:

1. OUTLINE CONFORMS TO EIA-481 & EIA-541.

Data and specifications subject to change without notice.  
This product has been designed and qualified for the consumer market.  
Qualification Standards can be found on IR's Web site.

International  
**IR** Rectifier

**IR WORLD HEADQUARTERS:** 233 Kansas St., El Segundo, California 90245, USA Tel: (310) 252-7105  
TAC Fax: (310) 252-7903

Visit us at [www.irf.com](http://www.irf.com) for sales contact information. 2/02