

INVERTER GRADE THYRISTORS

Hockey Puk Version

Features

- Metal case with ceramic insulator
- International standard case TO-200AB (A-PUK)
- All diffused design
- Center amplifying gate
- Guaranteed high dV/dt
- Guaranteed high dI/dt
- High surge current capability
- Low thermal impedance
- High speed performance

Typical Applications

- Inverters
- Choppers
- Induction heating
- All types of force-commutated converters

330A

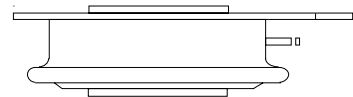

case style TO-200AB (A-PUK)

Major Ratings and Characteristics

Parameters	ST173C..C	Units
$I_{T(AV)}$	330	A
@ T_{hs}	55	°C
$I_{T(RMS)}$	610	A
@ T_{hs}	25	°C
I_{TSM}	@ 50Hz	4680
	@ 60Hz	4900
I^2t	@ 50Hz	110
	@ 60Hz	100
V_{DRM}/V_{RRM}	1000 to 1200	V
t_q range	15 to 30	μs
T_J	- 40 to 125	°C

ELECTRICAL SPECIFICATIONS

Voltage Ratings

Type number	Voltage Code	V_{DRM}/V_{RRM} , maximum repetitive peak voltage V	V_{RSM} , maximum non-repetitive peak voltage V	I_{DRM}/I_{RRM} max. @ $T_J = T_J$ max. mA
ST173C..C	10	1000	1100	40
	12	1200	1300	

Current Carrying Capability

Frequency							Units
50Hz	760	660	1200	1030	5570	4920	A
400Hz	730	590	1260	1080	2800	2460	
1000Hz	600	490	1200	1030	1620	1390	
2500Hz	350	270	850	720	800	680	
Recovery voltage Vr	50	50	50	50	50	50	
Voltage before turn-on Vd	V_{DRM}		V_{DRM}		V_{DRM}		
Rise of on-state current di/dt	50	50	-	-	-	-	A/µs
Heatsink temperature	40	55	40	55	40	55	°C
Equivalent values for RC circuit	47Ω / 0.22µF		47Ω / 0.22µF		47Ω / 0.22µF		

On-state Conduction

Parameter	ST173C..C	Units	Conditions		
$I_{T(AV)}$ Max. average on-state current @ Heatsink temperature	330 (120)	A	180° conduction, half sine wave double side (single side) cooled		
	55 (85)	°C			
$I_{T(RMS)}$ Max. RMS on-state current	610	A	DC @ 25°C heatsink temperature double side cooled		
I_{TSM} Max. peak, one half cycle, non-repetitive surge current	4680		t = 10ms	No voltage	Sinusoidal half wave, Initial $T_J = T_J$ max
	4900		t = 8.3ms	reapplied	
	3940		t = 10ms	100% V_{RRM}	
I^2t Maximum I^2t for fusing	4120	KA ² s	t = 8.3ms	reapplied	
	110		t = 10ms	No voltage	
	100		t = 8.3ms	reapplied	
	77		t = 10ms	100% V_{RRM}	
	71		t = 8.3ms	reapplied	
$I^2\sqrt{t}$ Maximum $I^2\sqrt{t}$ for fusing	1100	KA ² /s	t = 0.1 to 10ms, no voltage reapplied		

On-state Conduction

Parameter	ST173C..C	Units	Conditions
V_{TM} Max. peak on-state voltage	2.07	V	$I_{TM} = 600A, T_J = T_J \text{ max}, t_p = 10\text{ms sine wave pulse}$
$V_{T(TO)1}$ Low level value of threshold voltage	1.55		$(16.7\% \times \pi \times I_{T(AV)} < I < \pi \times I_{T(AV)}), T_J = T_J \text{ max.}$
$V_{T(TO)2}$ High level value of threshold voltage	1.61		$(I > \pi \times I_{T(AV)}), T_J = T_J \text{ max.}$
r_{t1} Low level value of forward slope resistance	0.87	m Ω	$(16.7\% \times \pi \times I_{T(AV)} < I < \pi \times I_{T(AV)}), T_J = T_J \text{ max.}$
r_{t2} High level value of forward slope resistance	0.77		$(I > \pi \times I_{T(AV)}), T_J = T_J \text{ max.}$
I_H Maximum holding current	600	mA	$T_J = 25^\circ\text{C}, I_T > 30A$
I_L Typical latching current	1000		$T_J = 25^\circ\text{C}, V_A = 12V, R_a = 6\Omega, I_G = 1A$

Switching

Parameter	ST173C..C	Units	Conditions
di/dt Max. non-repetitive rate of rise of turned-on current	1000	A/ μs	$T_J = T_J \text{ max}, V_{DRM} = \text{rated } V_{DRM}$ $I_{TM} = 2 \times \text{di/dt}$
t_d Typical delay time	1.1	μs	$T_J = 25^\circ\text{C}, V_{DM} = \text{rated } V_{DRM}, I_{TM} = 50A \text{ DC}, t_p = 1\mu\text{s}$ Resistive load, Gate pulse: 10V, 5 Ω source
t_q Max. turn-off time	Min 15 Max 30		$T_J = T_J \text{ max}, I_{TM} = 300A, \text{commutating di/dt} = 20A/\mu\text{s}$ $V_R = 50V, t_p = 500\mu\text{s}, \text{dv/dt: see table in device code}$

Blocking

Parameter	ST173C..C	Units	Conditions
dv/dt Maximum critical rate of rise of off-state voltage	500	V/ μs	$T_J = T_J \text{ max. linear to } 80\% V_{DRM}, \text{higher value available on request}$
I_{RRM} I_{DRM} Max. peak reverse and off-state leakage current	40	mA	$T_J = T_J \text{ max, rated } V_{DRM}/V_{RRM} \text{ applied}$

Triggering

Parameter	ST173C..C	Units	Conditions
P_{GM} Maximum peak gate power	60	W	$T_J = T_J \text{ max}, f = 50\text{Hz}, d\% = 50$
$P_{G(AV)}$ Maximum average gate power	10		
I_{GM} Max. peak positive gate current	10	A	$T_J = T_J \text{ max}, t_p \leq 5\text{ms}$
$+V_{GM}$ Maximum peak positive gate voltage	20	V	$T_J = T_J \text{ max}, t_p \leq 5\text{ms}$
$-V_{GM}$ Maximum peak negative gate voltage	5		
I_{GT} Max. DC gate current required to trigger	200	mA	$T_J = 25^\circ\text{C}, V_A = 12V, R_a = 6\Omega$
V_{GT} Max. DC gate voltage required to trigger	3		
I_{GD} Max. DC gate current not to trigger	20	mA	$T_J = T_J \text{ max, rated } V_{DRM} \text{ applied}$
V_{GD} Max. DC gate voltage not to trigger	0.25		

Thermal and Mechanical Specification

Parameter	ST173C..C	Units	Conditions
T _J Max. operating temperature range	-40 to 125	°C	
T _{stg} Max. storage temperature range	-40 to 150		
R _{thJ-hs} Max. thermal resistance, junction to heatsink	0.17 0.08	K/W	DC operation single side cooled DC operation double side cooled
R _{thC-hs} Max. thermal resistance, case to heatsink	0.033 0.017		K/W
F Mounting force, ± 10%	4900 (500)	N (Kg)	
wt Approximate weight	50	g	
Case style	TO-200AB (A-PUK)		See Outline Table

ΔR_{thJ-hs} Conduction

(The following table shows the increment of thermal resistance R_{thJ-hs} when devices operate at different conduction angles than DC)

Conduction angle	Sinusoidal conduction		Rectangular conduction		Units	Conditions
	Single Side	Double Side	Single Side	Double Side		
180°	0.015	0.016	0.011	0.011	K/W	T _J = T _J max.
120°	0.018	0.019	0.019	0.019		
90°	0.024	0.024	0.026	0.026		
60°	0.035	0.035	0.036	0.037		
30°	0.060	0.060	0.060	0.061		

Ordering Information Table

Device Code

ST	17	3	C	12	C	H	K	1		P
①	②	③	④	⑤	⑥	⑦	⑧	⑨	⑩	⑪

- 1** - Thyristor
- 2** - Essential part number
- 3** - 3 = Fast turn off
- 4** - C = Ceramic Puk
- 5** - Voltage code: Code x 100 = V_{RRM} (See Voltage Rating Table)
- 6** - C = Puk Case TO-200AB (A-PUK)
- 7** - Reapplied dv/dt code (for t_q test condition)
- 8** - t_q code
- 9** - 0 = Eyelet term. (Gate and Aux. Cathode Unsoldered Leads)
 1 = Fast-on term. (Gate and Aux. Cathode Unsoldered Leads)
 2 = Eyelet term. (Gate and Aux. Cathode Soldered Leads)
 3 = Fast-on term. (Gate and Aux. Cathode Soldered Leads)
- 10** - Critical dv/dt:
 None = 500V/μsec (Standard value)
 L = 1000V/μsec (Special selection)
- 11** - P = Lead Free

dv/dt - t _q combinations available					
dv/dt (V/μs)	20	50	100	200	400
15	CL	--	--	--	--
18	CP	DP	EP	FP *	--
20	CK	DK	EK	FK *	HK
25	CJ	DJ	EJ	FJ	HJ
30	--	DH	EH	FH	HH

*Standard part number.
All other types available only on request.

Outline Table

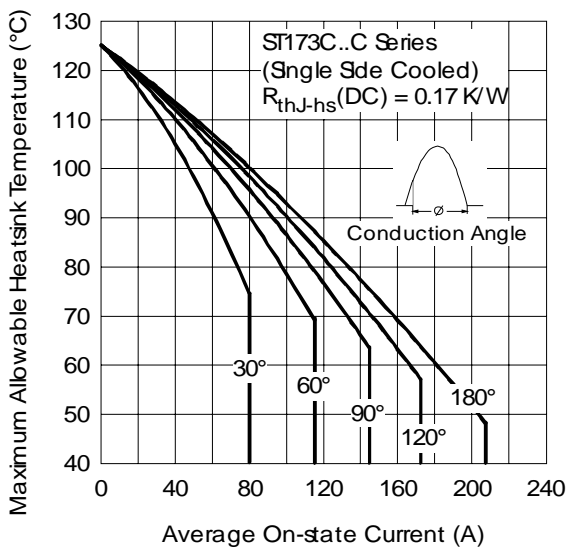
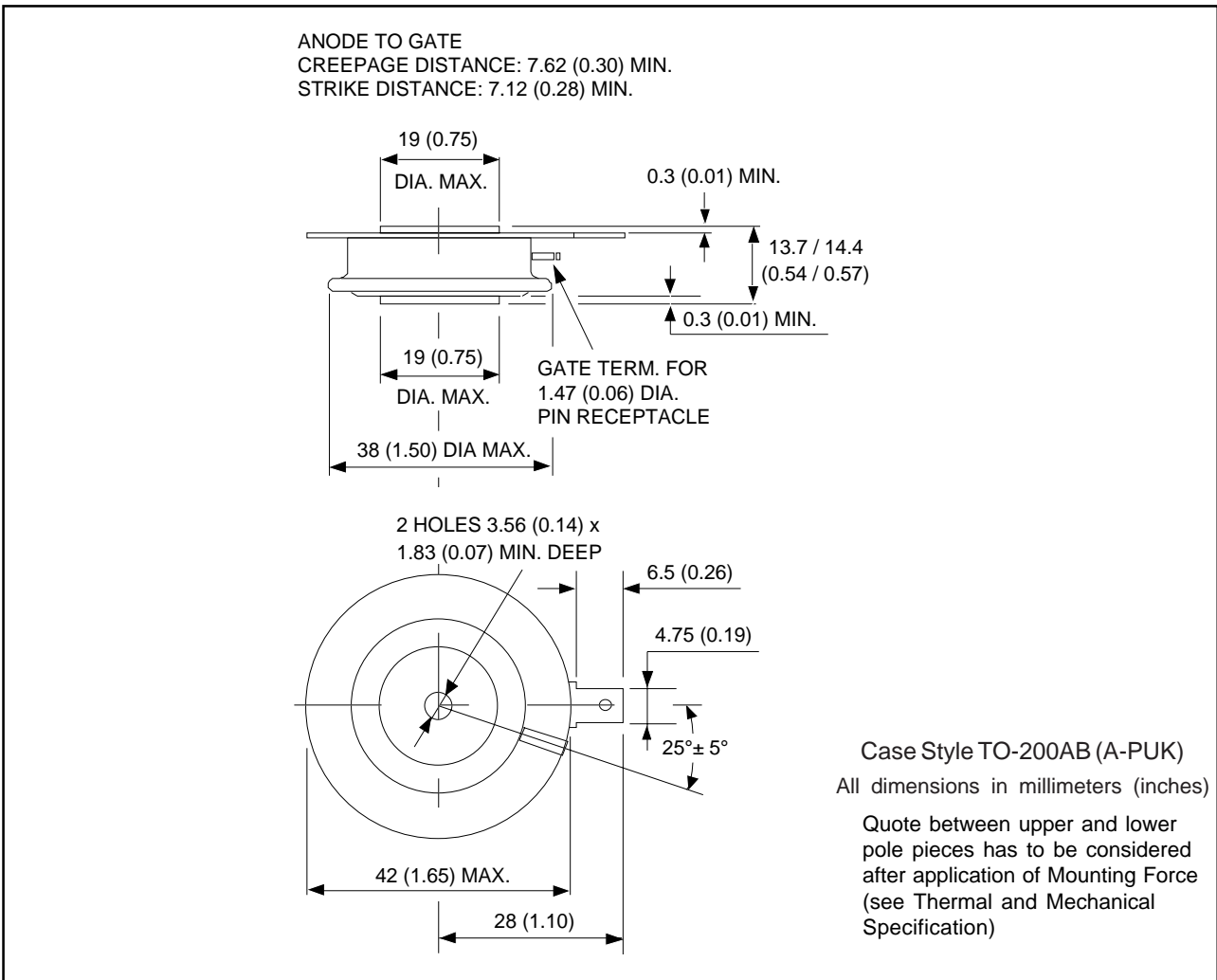

Fig. 1 - Current Ratings Characteristics

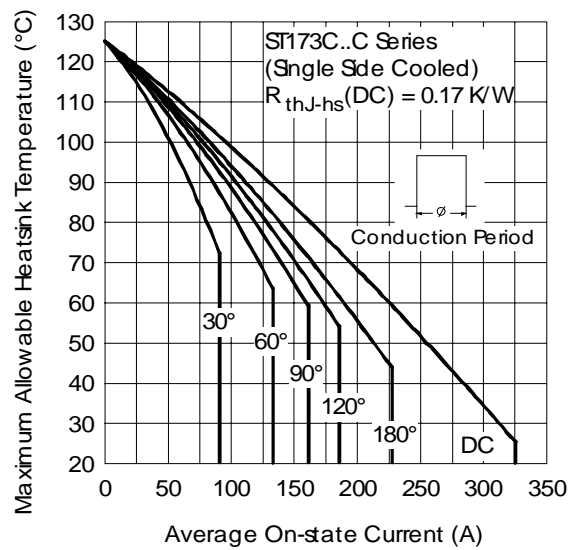

Fig. 2 - Current Ratings Characteristics

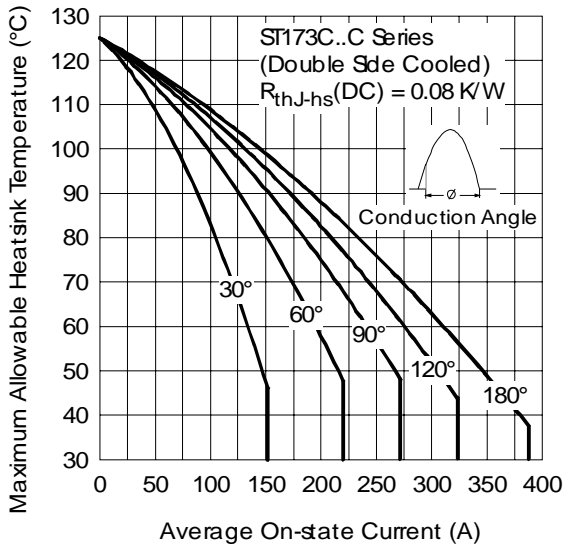

Fig. 3 - Current Ratings Characteristics

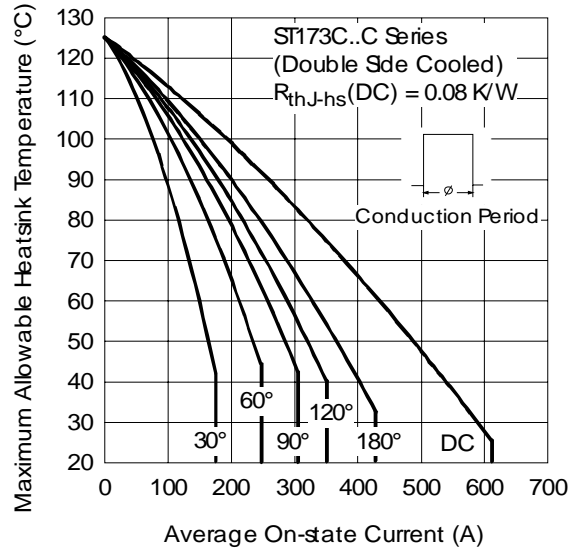

Fig. 4 - Current Ratings Characteristics

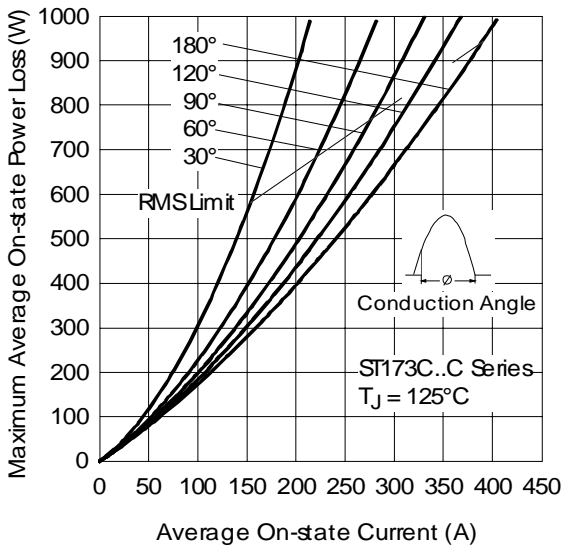

Fig. 5 - On-state Power Loss Characteristics

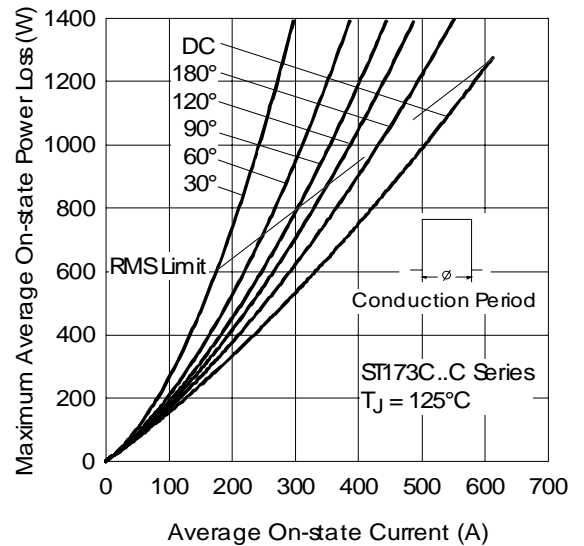

Fig. 6 - On-state Power Loss Characteristics

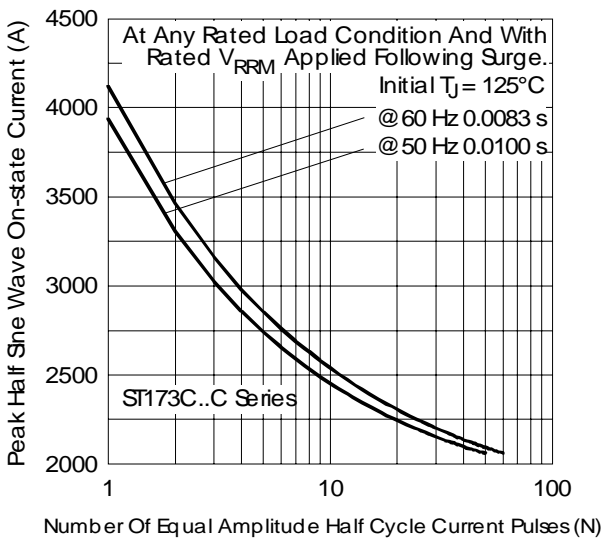

Fig. 7 - Maximum Non-repetitive Surge Current Single and Double Side Cooled

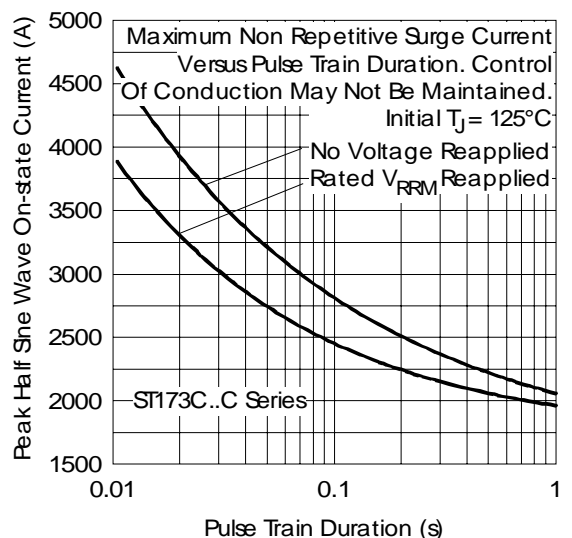

Fig. 8 - Maximum Non-repetitive Surge Current Single and Double Side Cooled

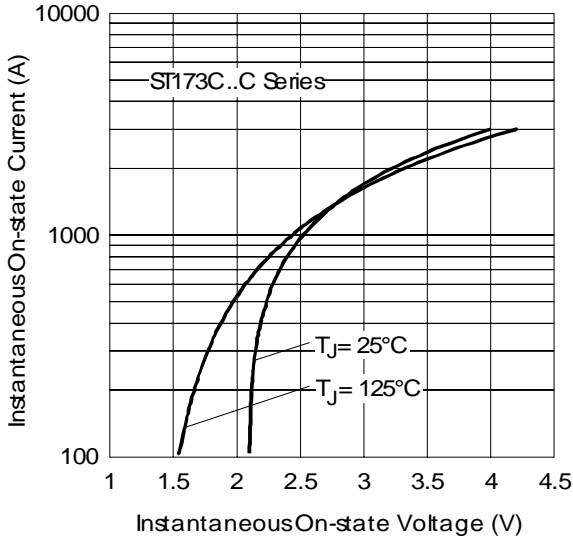

Fig. 9 - On-state Voltage Drop Characteristics

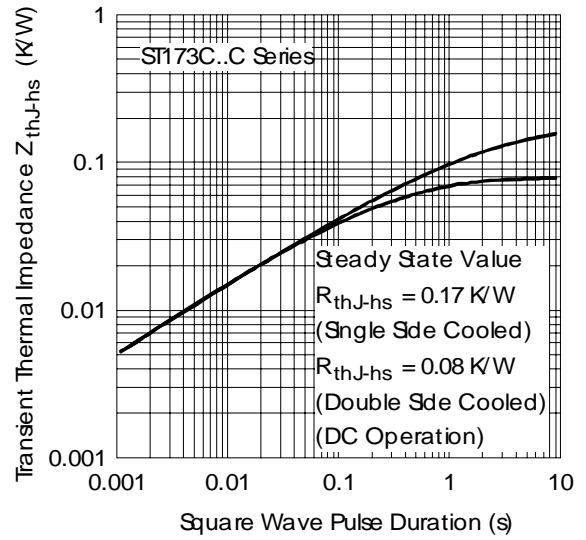

Fig. 10 - Thermal Impedance Z_{thJ-hs} Characteristics

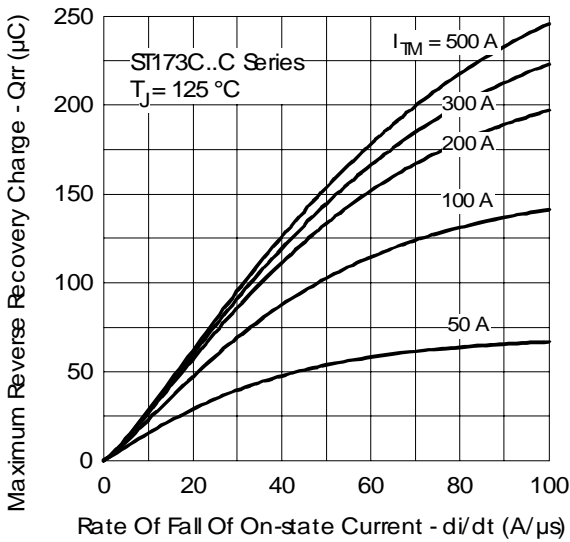

Fig. 11 - Reverse Recovered Charge Characteristics

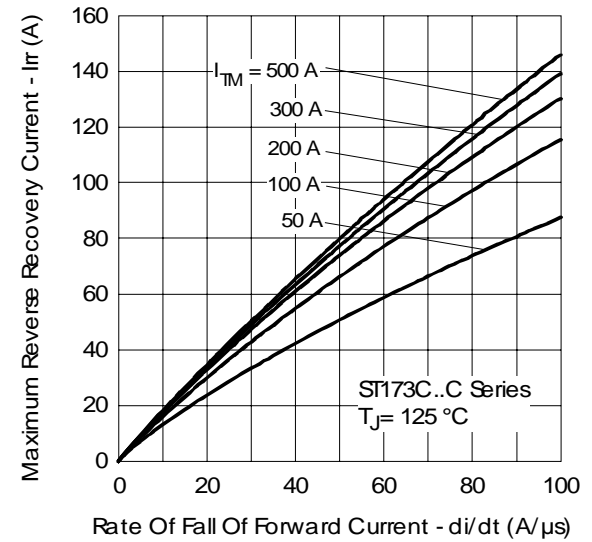

Fig. 12 - Reverse Recovery Current Characteristics

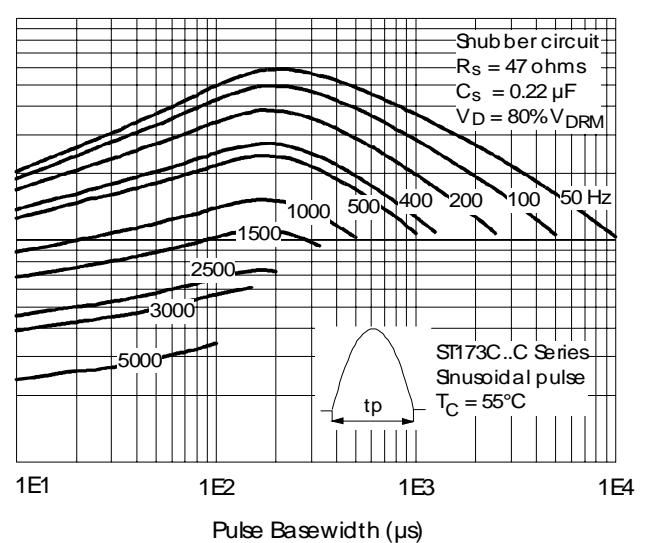

Fig. 13 - Frequency Characteristics

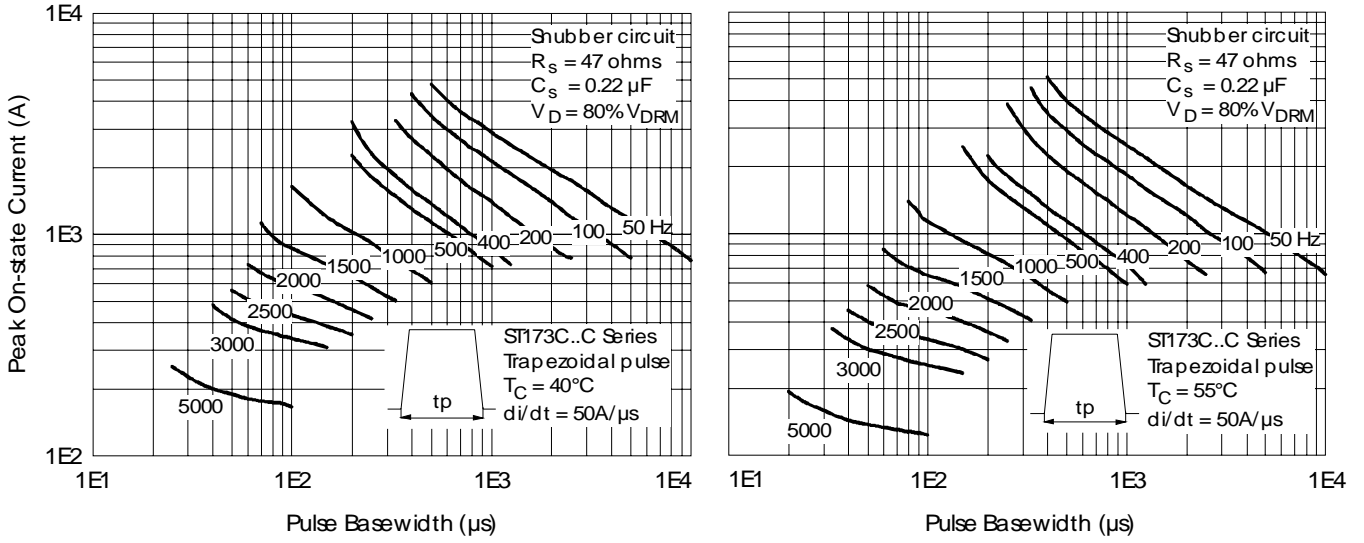

Fig. 14 - Frequency Characteristics

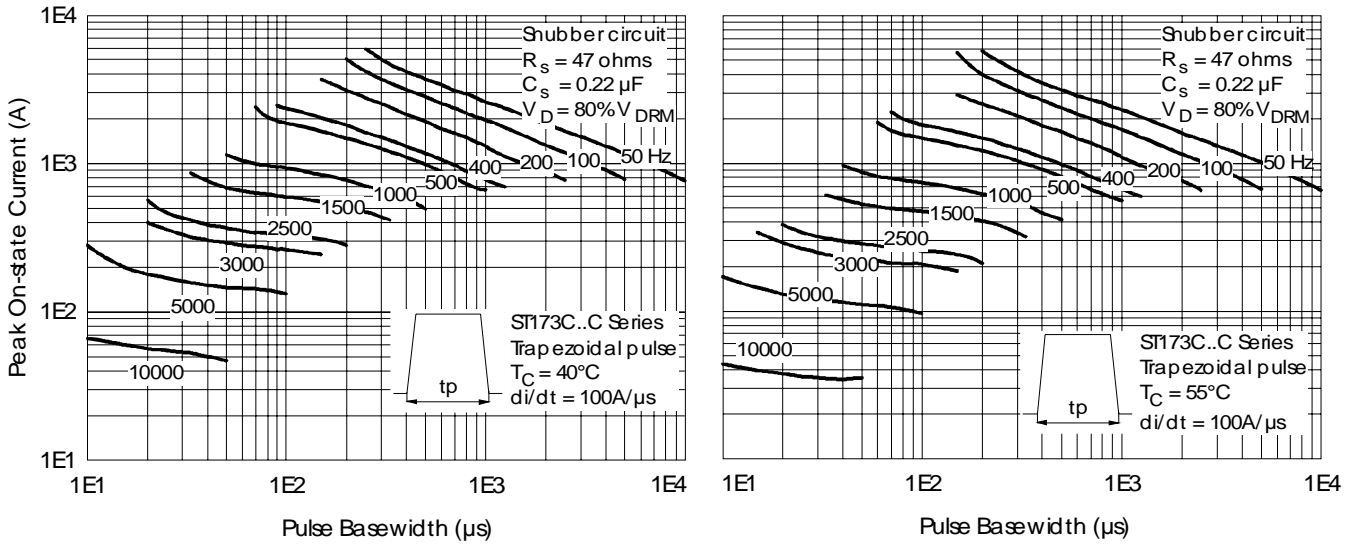

Fig. 15 - Frequency Characteristics

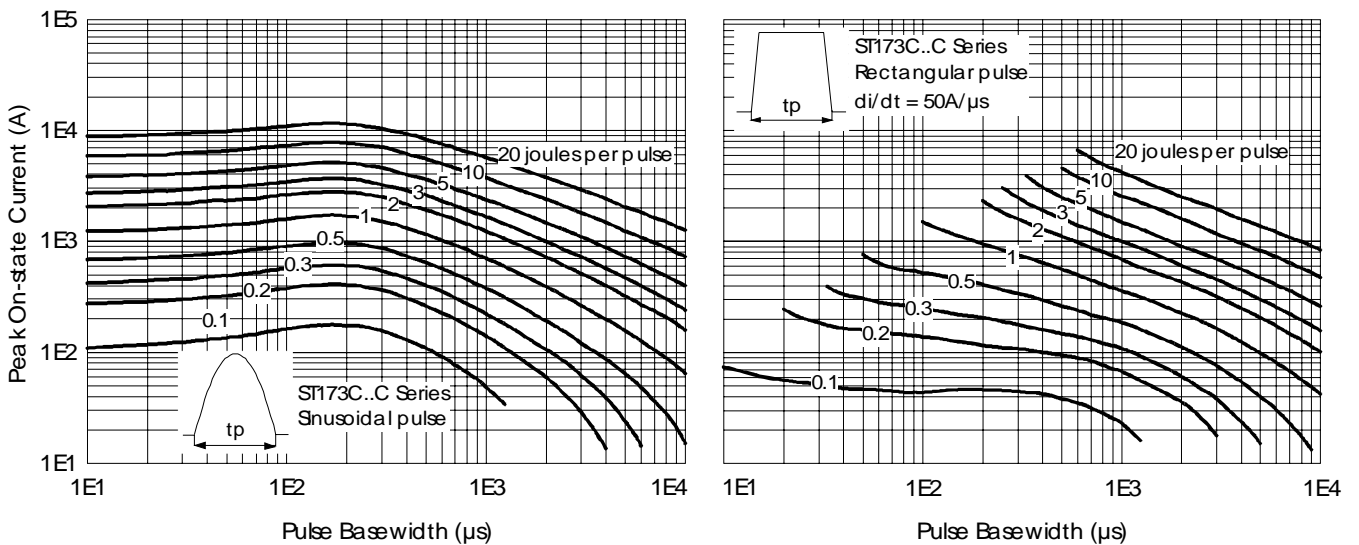

Fig. 16 - Maximum On-state Energy Power Loss Characteristics

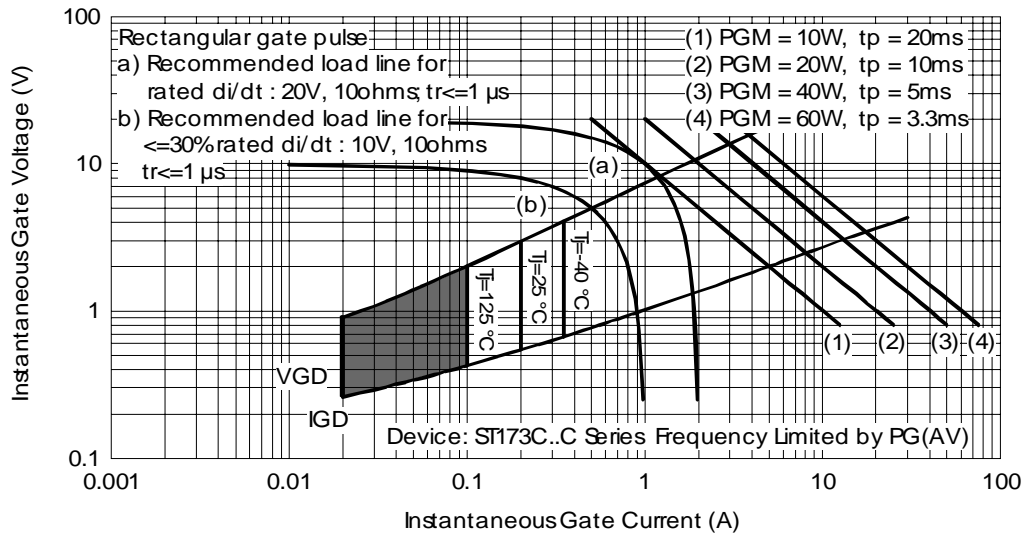

Fig. 17 - Gate Characteristics

Data and specifications subject to change without notice.
This product has been designed and qualified for Industrial Level and Lead-Free.
Qualification Standards can be found on IR's Web site.