

# PolarHT™ Power MOSFET

**IXTQ 96N15P**  
**IXTT 96N15P**

$V_{DSS} = 150 \text{ V}$   
 $I_{D25} = 96 \text{ A}$   
 $R_{DS(on)} = 24 \text{ m}\Omega$

N-Channel Enhancement Mode

Preliminary Data Sheet

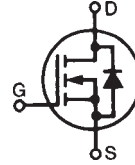

Symbol	Test Conditions	Maximum Ratings	
$V_{DSS}$	$T_J = 25^\circ\text{C to } 175^\circ\text{C}$	150	V
$V_{DGR}$	$T_J = 25^\circ\text{C to } 175^\circ\text{C}; R_{GS} = 1 \text{ M}\Omega$	150	V
$V_{GSM}$		$\pm 20$	V
$I_{D25}$	$T_C = 25^\circ\text{C}$	96	A
$I_{D(RMS)}$	External lead current limit	75	A
$I_{DM}$	$T_C = 25^\circ\text{C}$ , pulse width limited by $T_{JM}$	250	A
$I_{AR}$	$T_C = 25^\circ\text{C}$	60	A
$E_{AR}$	$T_C = 25^\circ\text{C}$	40	mJ
$E_{AS}$	$T_C = 25^\circ\text{C}$	1.0	J
$dv/dt$	$I_S \leq I_{DM}$ , $di/dt \leq 100 \text{ A}/\mu\text{s}$ , $V_{DD} \leq V_{DSS}$ , $T_J \leq 150^\circ\text{C}$ , $R_G = 4 \Omega$	10	V/ns
$P_D$	$T_C = 25^\circ\text{C}$	480	W
$T_J$		-55 ... +175	$^\circ\text{C}$
$T_{JM}$		175	$^\circ\text{C}$
$T_{stg}$		-55 ... +150	$^\circ\text{C}$
$T_L$	1.6 mm (0.062 in.) from case for 10 s	300	$^\circ\text{C}$
$M_d$	Mounting torque (TO-3P)	1.13/10	Nm/lb.in.
Weight	TO-3P	5.5	g
	TO-268	5.0	g

TO-3P (IXTQ)

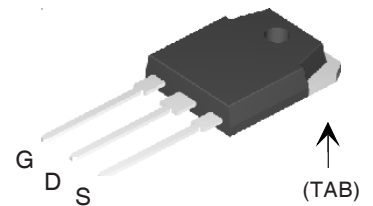

TO-268 (IXTT)

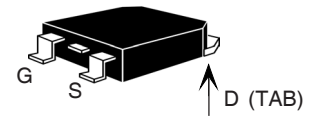

G = Gate      D = Drain  
S = Source      TAB = Drain

### Features

- International standard packages
- Unclamped Inductive Switching (UIS) rated
- Low package inductance  
- easy to drive and to protect

### Advantages

- Easy to mount
- Space savings
- High power density

Symbol	Test Conditions ( $T_J = 25^\circ\text{C}$ , unless otherwise specified)	Characteristic Values		
		Min.	Typ.	Max.
$V_{DSS}$	$V_{GS} = 0 \text{ V}$ , $I_D = 250 \mu\text{A}$	150		V
$V_{GS(th)}$	$V_{DS} = V_{GS}$ , $I_D = 250 \mu\text{A}$	2.5		5.0 V
$I_{GSS}$	$V_{GS} = \pm 20 \text{ V}_{DC}$ , $V_{DS} = 0$			$\pm 100 \text{ nA}$
$I_{DSS}$	$V_{DS} = V_{DSS}$ $V_{GS} = 0 \text{ V}$ $T_J = 150^\circ\text{C}$			25 $\mu\text{A}$
				250 $\mu\text{A}$
$R_{DS(on)}$	$V_{GS} = 10 \text{ V}$ , $I_D = 0.5 I_{D25}$ Pulse test, $t \leq 300 \mu\text{s}$ , duty cycle $d \leq 2\%$			24 $\text{m}\Omega$

**PolarHT™ DMOS transistors utilize proprietary designs and process. US patent is pending.**

Symbol	Test Conditions	Characteristic Values		
		(T <sub>J</sub> = 25°C, unless otherwise specified)		
		Min.	Typ.	Max.
<b>g<sub>fs</sub></b>	V <sub>DS</sub> = 10 V; I <sub>D</sub> = 0.5 I <sub>D25</sub> , pulse test	35	45	S
<b>C<sub>iss</sub></b>	V <sub>GS</sub> = 0 V, V <sub>DS</sub> = 25 V, f = 1 MHz		3500	pF
<b>C<sub>oss</sub></b>		1000	pF	
<b>C<sub>rss</sub></b>		280	pF	
<b>t<sub>d(on)</sub></b>	V <sub>GS</sub> = 10 V, V <sub>DS</sub> = 0.5 V <sub>DSS</sub> , I <sub>D</sub> = 60 A R <sub>G</sub> = 4 Ω (External)		30	ns
<b>t<sub>r</sub></b>		33	ns	
<b>t<sub>d(off)</sub></b>		66	ns	
<b>t<sub>f</sub></b>		18	ns	
<b>Q<sub>g(on)</sub></b>	V <sub>GS</sub> = 10 V, V <sub>DS</sub> = 0.5 V <sub>DSS</sub> , I <sub>D</sub> = 0.5 I <sub>D25</sub>		110	nC
<b>Q<sub>gs</sub></b>		26	nC	
<b>Q<sub>gd</sub></b>		59	nC	
<b>R<sub>thJC</sub></b>	(TO-3P)			0.31 K/W
<b>R<sub>thCK</sub></b>		0.21	K/W	

Symbol	Test Conditions	Characteristic Values		
		(T <sub>J</sub> = 25°C, unless otherwise specified)		
		Min.	typ.	Max.
<b>I<sub>s</sub></b>	V <sub>GS</sub> = 0 V			96 A
<b>I<sub>SM</sub></b>	Repetitive			250 A
<b>V<sub>SD</sub></b>	I <sub>F</sub> = I <sub>S</sub> , V <sub>GS</sub> = 0 V, Pulse test, t ≤ 300 μs, duty cycle d ≤ 2 %			1.5 V
<b>t<sub>rr</sub></b>	I <sub>F</sub> = 25 A -di/dt = 100 A/μs		150	ns
<b>Q<sub>RM</sub></b>		V <sub>R</sub> = 100 V	2.0	μC

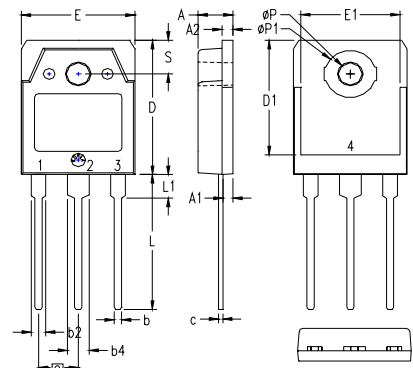
**TO-3P (IXTQ) Outline**

- 1 - GATE
- 2 - DRAIN (COLLECTOR)
- 3 - SOURCE (EMITTER)
- 4 - DRAIN (COLLECTOR)

SYM	INCHES		MILLIMETERS	
	MIN	MAX	MIN	MAX
A	.185	.193	4.70	4.90
A1	.051	.059	1.30	1.50
A2	.057	.065	1.45	1.65
b	.035	.045	0.90	1.15
b2	.075	.087	1.90	2.20
b4	.114	.126	2.90	3.20
c	.022	.031	0.55	0.80
D	.780	.791	19.80	20.10
D1	.665	.677	16.90	17.20
E	.610	.622	15.50	15.80
E1	.531	.539	13.50	13.70
e	.215 BSC		5.45 BSC	
L	.779	.795	19.80	20.20
L1	.134	.142	3.40	3.60
L2	.126	.134	3.20	3.40
øP	.272	.280	6.90	7.10
S	.193	.201	4.90	5.10

All metal area are tin plated.

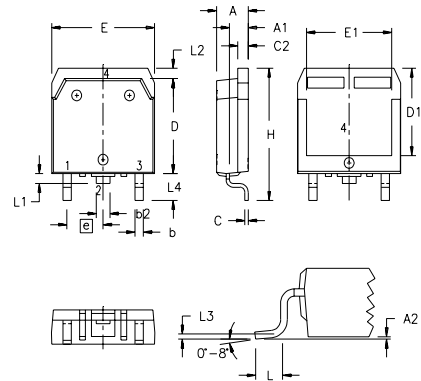
**TO-268 Outline**

SYM	INCHES		MILLIMETERS	
	MIN	MAX	MIN	MAX
A	.193	.201	4.90	5.10
A1	.106	.114	2.70	2.90
A2	.001	.010	0.02	0.25
b	.045	.057	1.15	1.45
b2	.075	.083	1.90	2.10
C	.016	.026	0.40	0.65
C2	.057	.063	1.45	1.60
D	.543	.551	13.80	14.00
D1	.488	.500	12.40	12.70
E	.624	.632	15.85	16.05
E1	.524	.535	13.30	13.60
e	.215 BSC		5.45 BSC	
H	.736	.752	18.70	19.10
L	.094	.106	2.40	2.70
L1	.047	.055	1.20	1.40
L2	.039	.045	1.00	1.15
L3	.010 BSC		0.25 BSC	
L4	.150	.161	3.80	4.10

IXYS reserves the right to change limits, test conditions, and dimensions.

IXYS MOSFETs and IGBTs are covered by one or more of the following U.S. patents:	4,835,592	4,931,844	5,049,961	5,237,481	6,162,665	6,404,065B1	6,683,344	6,727,585
	4,850,072	5,017,508	5,063,307	5,381,025	6,259,123B1	6,534,343	6,710,405B2	
	4,881,106	5,034,796	5,187,117	5,486,715	6,306,728 B1	6,583,505	6,710,463	

**Fig. 1. Output Characteristics @ 25°C**

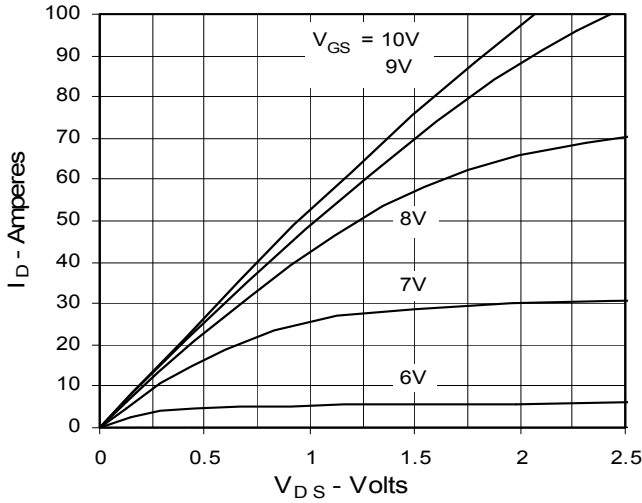

**Fig. 2. Extended Output Characteristics @ 25°C**

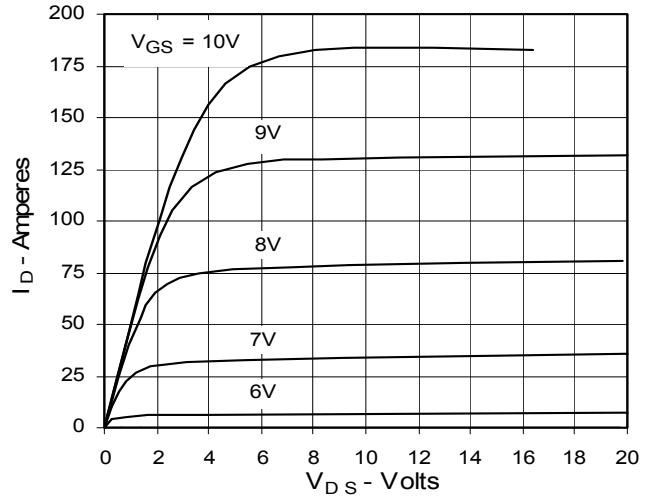

**Fig. 3. Output Characteristics @ 150°C**

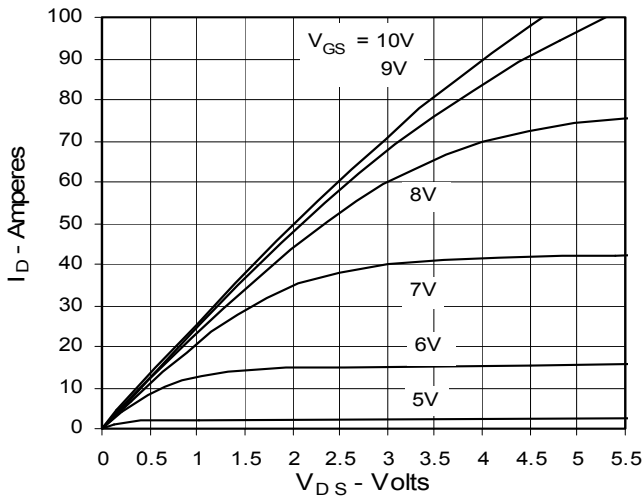

**Fig. 4.  $R_{DS(on)}$  Normalized to 0.5  $I_{D25}$  Value vs. Junction Temperature**

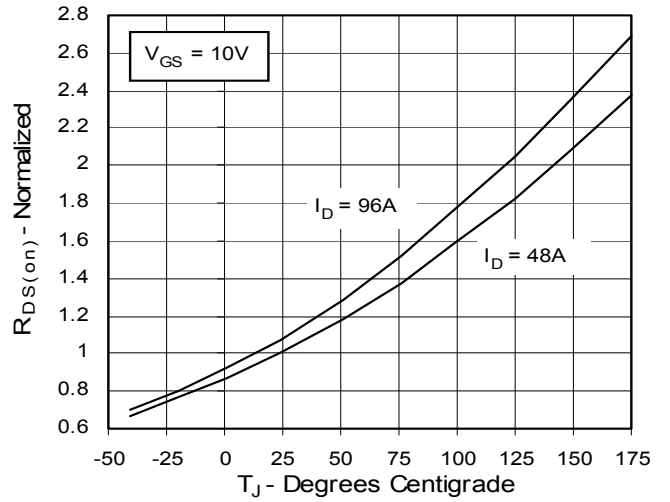

**Fig. 5.  $R_{DS(on)}$  Normalized to 0.5  $I_{D25}$  Value vs.  $I_D$**

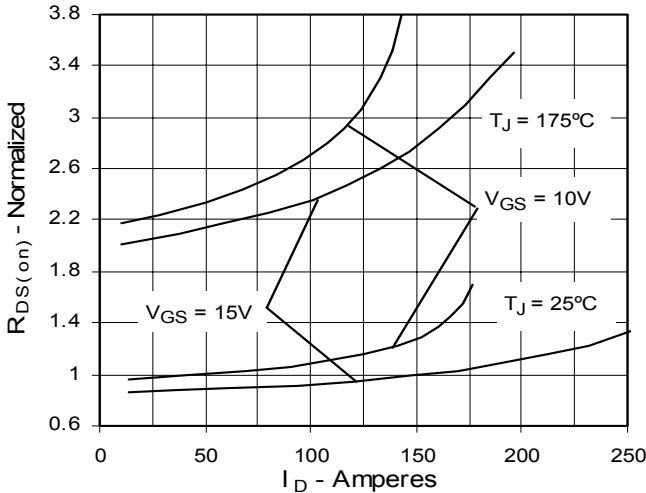

**Fig. 6. Drain Current vs. Case Temperature**

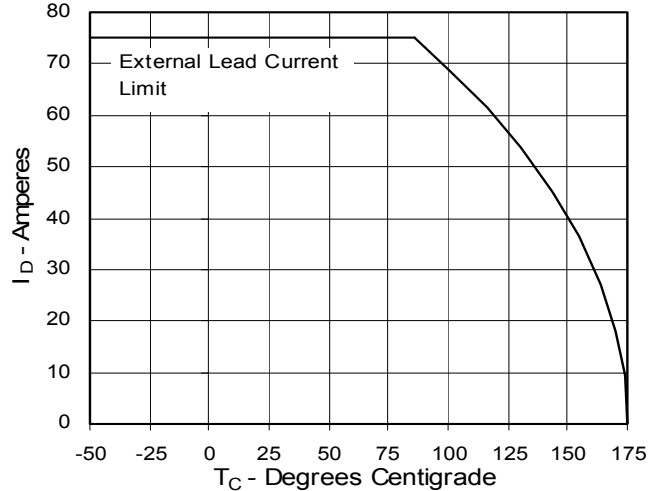

**Fig. 7. Input Admittance**

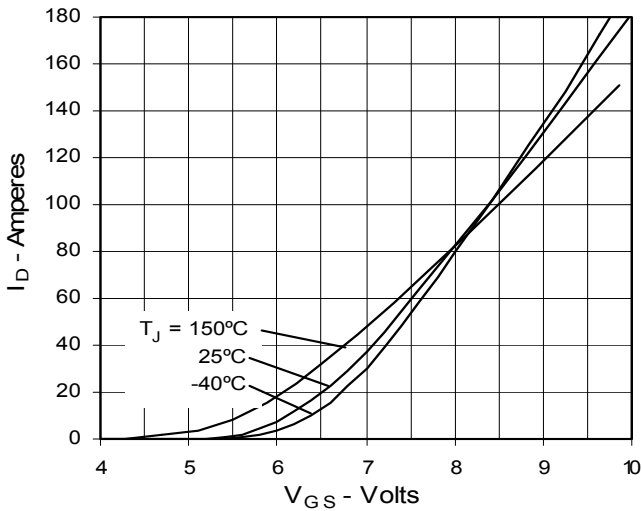

**Fig. 8. Transconductance**

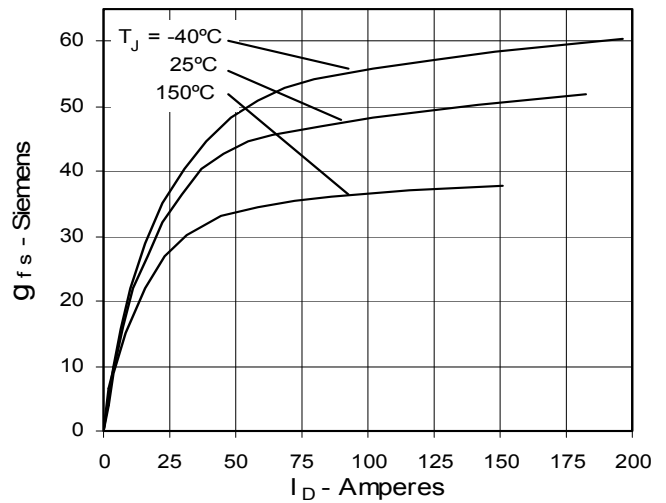

**Fig. 9. Source Current vs. Source-To-Drain Voltage**

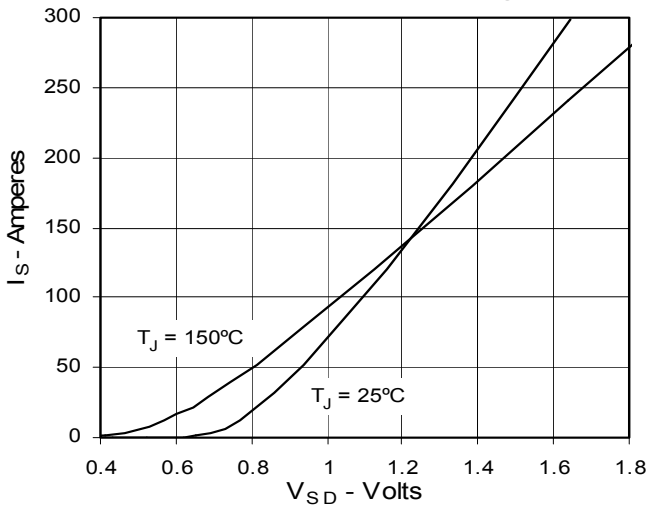

**Fig. 10. Gate Charge**

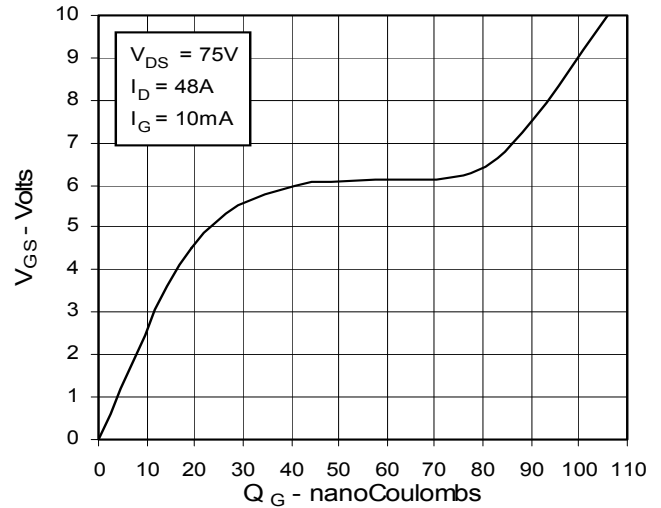

**Fig. 11. Capacitance**

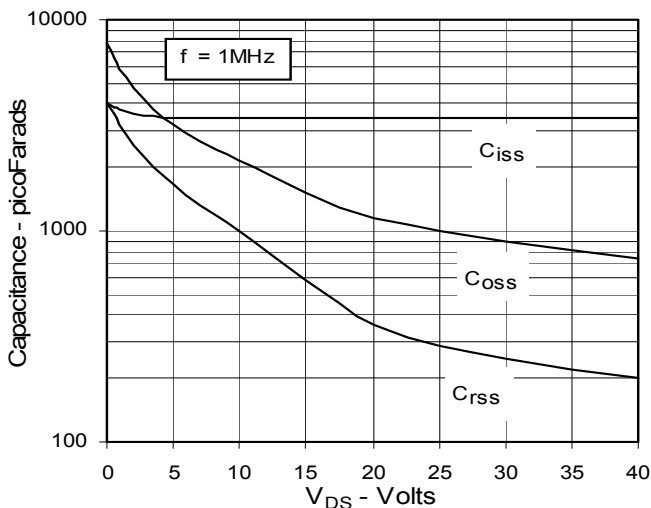

**Fig. 12. Forward-Bias Safe Operating Area**

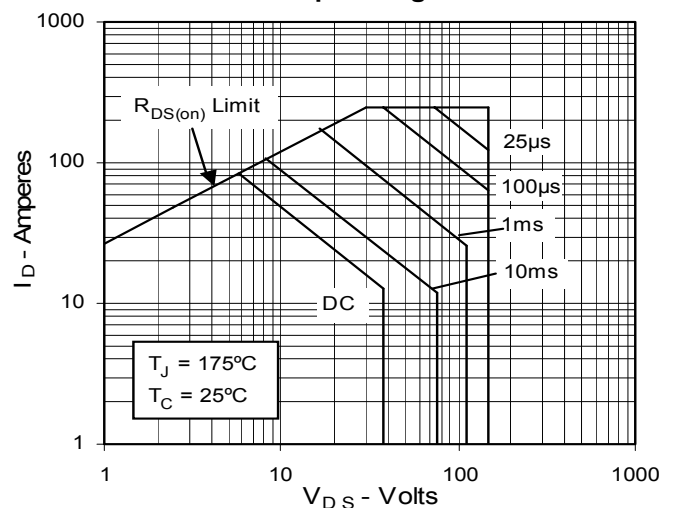

Fig. 13. Maximum Transient Thermal Resistance

