

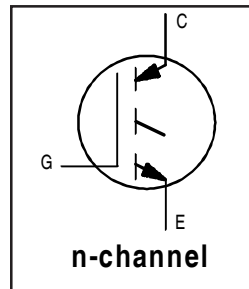
# IRG4PC40UPbF

INSULATED GATE BIPOLAR TRANSISTOR

UltraFast Speed IGBT

## Features

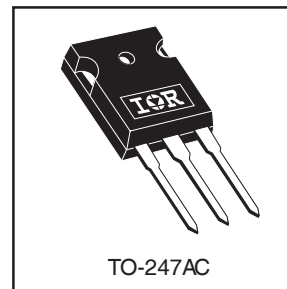
- UltraFast: Optimized for high operating frequencies 8-40 kHz in hard switching, >200 kHz in resonant mode
- Generation 4 IGBT design provides tighter parameter distribution and higher efficiency than Generation 3
- Industry standard TO-247AC package
- Lead-Free



$V_{CES} = 600V$
$V_{CE(on) typ.} = 1.72V$
@ $V_{GE} = 15V, I_C = 20A$

## Benefits

- Generation 4 IGBT's offer highest efficiency available
- IGBT's optimized for specified application conditions
- Designed to be a "drop-in" replacement for equivalent industry-standard Generation 3 IR IGBT's



## Absolute Maximum Ratings

	Parameter	Max.	Units
$V_{CES}$	Collector-to-Emitter Voltage	600	V
$I_C @ T_C = 25^\circ C$	Continuous Collector Current	40	A
$I_C @ T_C = 100^\circ C$	Continuous Collector Current	20	
$I_{CM}$	Pulsed Collector Current ①	160	
$I_{LM}$	Clamped Inductive Load Current ②	160	
$V_{GE}$	Gate-to-Emitter Voltage	$\pm 20$	V
$E_{ARV}$	Reverse Voltage Avalanche Energy ③	15	mJ
$P_D @ T_C = 25^\circ C$	Maximum Power Dissipation	160	W
$P_D @ T_C = 100^\circ C$	Maximum Power Dissipation	65	
$T_J$	Operating Junction and Storage Temperature Range	-55 to +150	°C
$T_{STG}$			
	Soldering Temperature, for 10 sec.	300 (0.063 in. (1.6mm) from case)	
	Mounting torque, 6-32 or M3 screw.	10 lbf•in (1.1N•m)	

## Thermal Resistance

	Parameter	Min.	Typ.	Max.	Units
$R_{\theta JC}$	Junction-to-Case	-----	-----	0.77	°C/W
$R_{\theta CS}$	Case-to-Sink, flat, greased surface	-----	0.24	-----	
$R_{\theta JA}$	Junction-to-Ambient, typical socket mount	-----	-----	40	
Wt	Weight	-----	6 (0.21)	-----	g (oz)

## Electrical Characteristics @ $T_J = 25^\circ\text{C}$ (unless otherwise specified)

	Parameter	Min.	Typ.	Max.	Units	Conditions	
$V_{(BR)CES}$	Collector-to-Emitter Breakdown Voltage	600	----	----	V	$V_{GE} = 0V, I_C = 250\mu A$	
$V_{(BR)ECS}$	Emitter-to-Collector Breakdown Voltage ④	18	----	----	V	$V_{GE} = 0V, I_C = 1.0A$ See Fig. 2, 5	
$\Delta V_{(BR)CES}/\Delta T_J$	Temperature Coeff. of Breakdown Voltage	----	0.63	----	$V/^\circ\text{C}$	$V_{GE} = 0V, I_C = 1.0mA$	
$V_{CE(on)}$	Collector-to-Emitter Saturation Voltage	----	1.72	2.1	V	$I_C = 20A, V_{GE} = 15V$	
		----	2.15	----			$I_C = 40A$
		----	1.7	----			$I_C = 20A, T_J = 150^\circ\text{C}$
$V_{GE(th)}$	Gate Threshold Voltage	3.0	----	6.0		$V_{CE} = V_{GE}, I_C = 250\mu A$	
$\Delta V_{GE(th)}/\Delta T_J$	Temperature Coeff. of Threshold Voltage	----	-13	----	$mV/^\circ\text{C}$	$V_{CE} = V_{GE}, I_C = 250\mu A$	
$g_{fe}$	Forward Transconductance ⑤	11	18	----	S	$V_{CE} = 100V, I_C = 20A$	
$I_{CES}$	Zero Gate Voltage Collector Current	----	----	250	$\mu A$	$V_{GE} = 0V, V_{CE} = 600V$	
		----	----	2.0		$V_{GE} = 0V, V_{CE} = 10V, T_J = 25^\circ\text{C}$	
		----	----	2500		$V_{GE} = 0V, V_{CE} = 600V, T_J = 150^\circ\text{C}$	
$I_{GES}$	Gate-to-Emitter Leakage Current	----	----	$\pm 100$	nA	$V_{GE} = \pm 20V$	

## Switching Characteristics @ $T_J = 25^\circ\text{C}$ (unless otherwise specified)

	Parameter	Min.	Typ.	Max.	Units	Conditions
$Q_g$	Total Gate Charge (turn-on)	----	100	150	nC	$I_C = 20A, V_{CC} = 400V, V_{GE} = 15V$ See Fig. 8
$Q_{ge}$	Gate - Emitter Charge (turn-on)	----	16	25		
$Q_{gc}$	Gate - Collector Charge (turn-on)	----	40	60		
$t_{d(on)}$	Turn-On Delay Time	----	34	----	ns	$T_J = 25^\circ\text{C}, I_C = 20A, V_{CC} = 480V, V_{GE} = 15V, R_G = 10\Omega$ Energy losses include "tail"
$t_r$	Rise Time	----	19	----		
$t_{d(off)}$	Turn-Off Delay Time	----	110	175		
$t_f$	Fall Time	----	120	180	mJ	See Fig. 10, 11, 13, 14
$E_{on}$	Turn-On Switching Loss	----	0.32	----		
$E_{off}$	Turn-Off Switching Loss	----	0.35	----		
$E_{ts}$	Total Switching Loss	----	0.67	1.0	mJ	$T_J = 150^\circ\text{C}, I_C = 20A, V_{CC} = 480V, V_{GE} = 15V, R_G = 10\Omega$ Energy losses include "tail"
$t_{d(on)}$	Turn-On Delay Time	----	30	----		
$t_r$	Rise Time	----	19	----		
$t_{d(off)}$	Turn-Off Delay Time	----	220	----	ns	$T_J = 150^\circ\text{C}, I_C = 20A, V_{CC} = 480V, V_{GE} = 15V, R_G = 10\Omega$ Energy losses include "tail"
$t_f$	Fall Time	----	160	----		
$E_{ts}$	Total Switching Loss	----	1.4	----		
$L_E$	Internal Emitter Inductance	----	13	----	nH	Measured 5mm from package
$C_{ies}$	Input Capacitance	----	2100	----	pF	$V_{GE} = 0V, V_{CC} = 30V, f = 1.0MHz$ See Fig. 7
$C_{oes}$	Output Capacitance	----	140	----		
$C_{res}$	Reverse Transfer Capacitance	----	34	----		

### Notes:

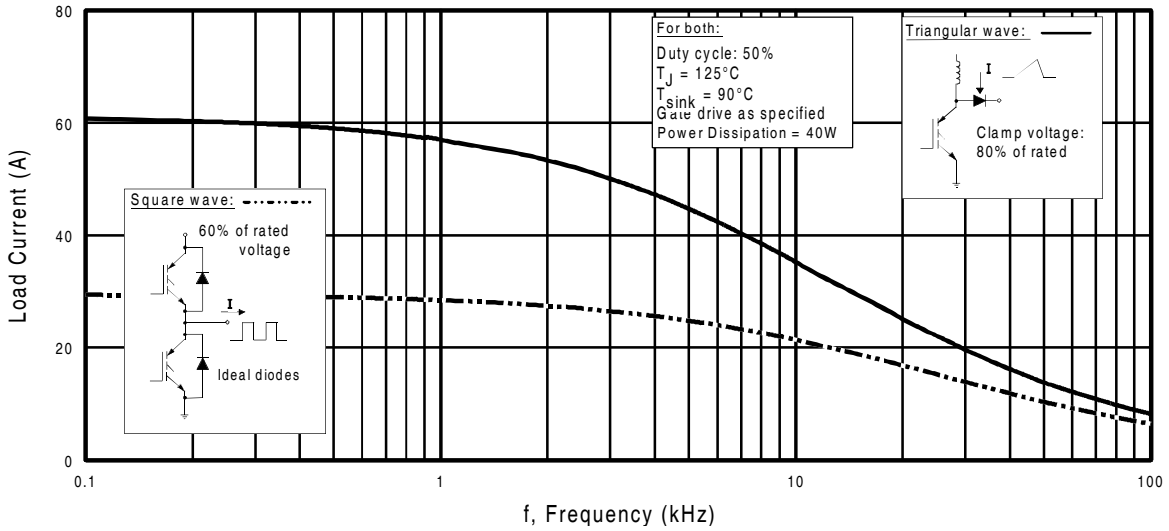
① Repetitive rating;  $V_{GE} = 20V$ , pulse width limited by max. junction temperature. ( See fig. 13b )

②  $V_{CC} = 80\%(V_{CES}), V_{GE} = 20V, L = 10\mu H, R_G = 10\Omega$ , (See fig. 13a)

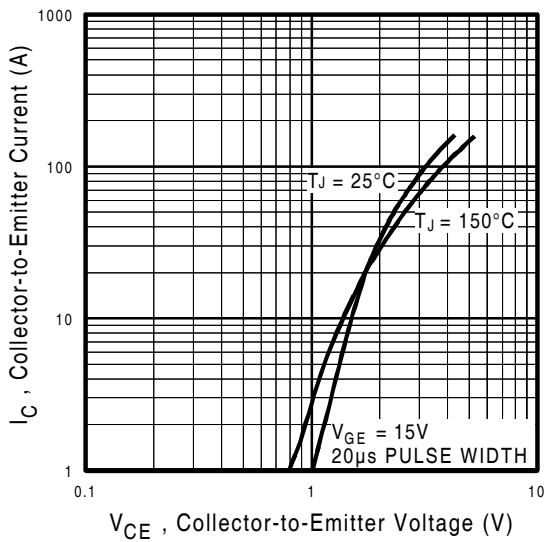
③ Repetitive rating; pulse width limited by maximum junction temperature.

④ Pulse width  $\leq 80\mu s$ ; duty factor  $\leq 0.1\%$ .

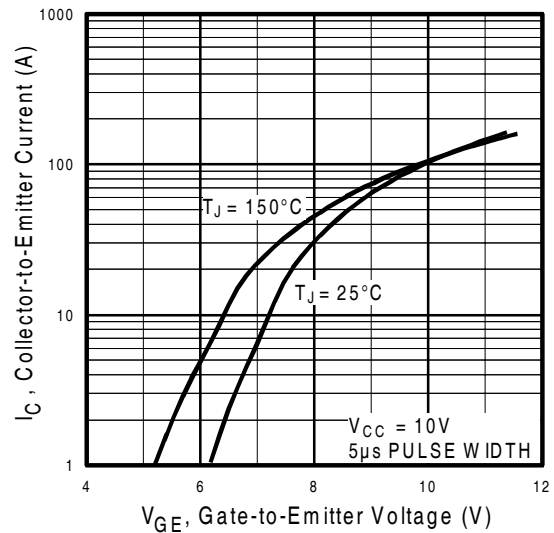
⑤ Pulse width  $5.0\mu s$ , single shot.



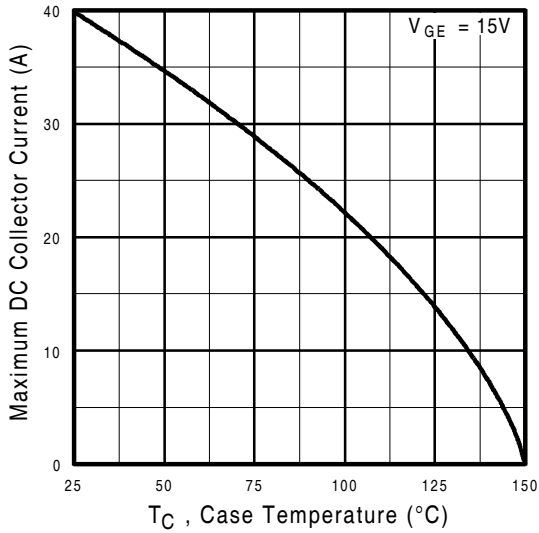
**Fig. 1 - Typical Load Current vs. Frequency**  
(For square wave,  $I = I_{RMS}$  of fundamental; for triangular wave,  $I = I_{PK}$ )



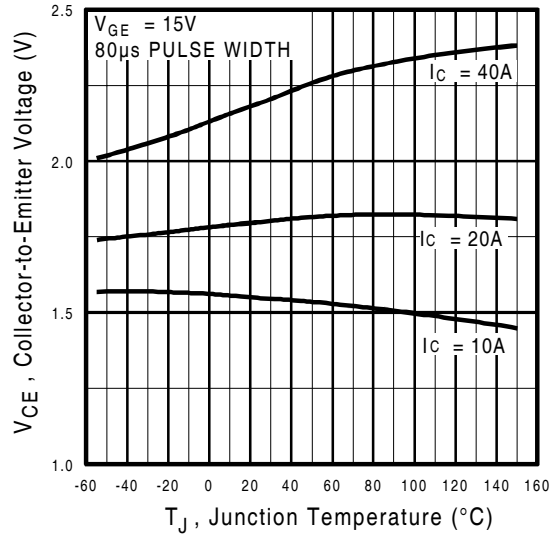
**Fig. 2 - Typical Output Characteristics**



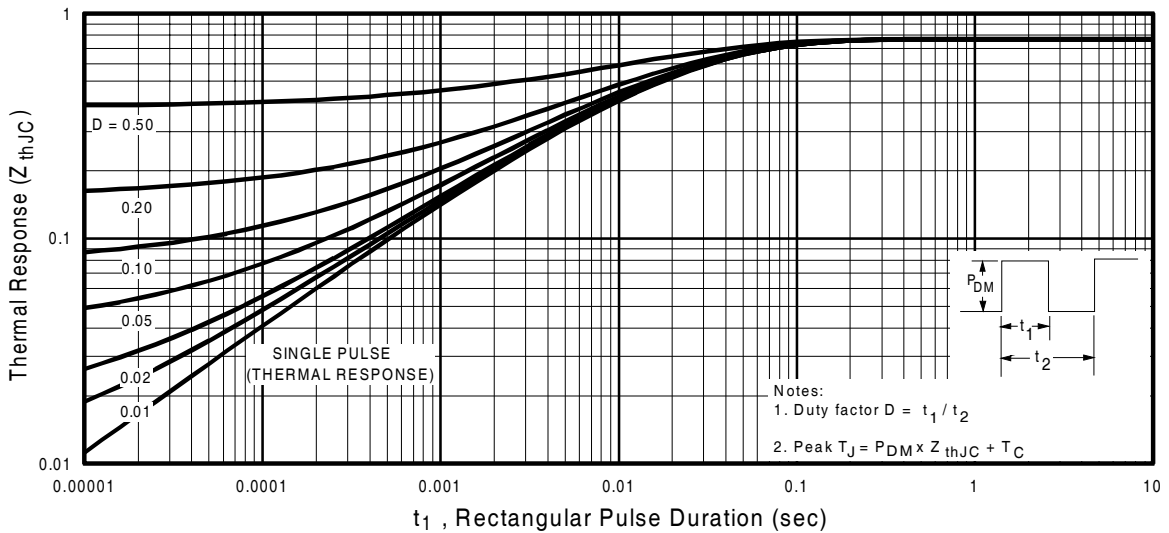
**Fig. 3 - Typical Transfer Characteristics**



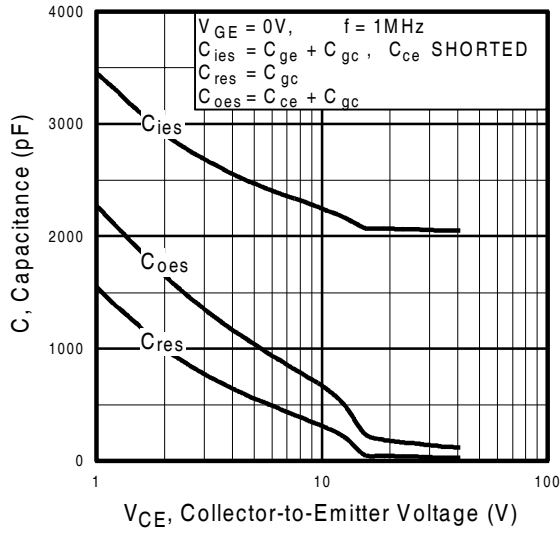
**Fig. 4 - Maximum Collector Current vs. Case Temperature**



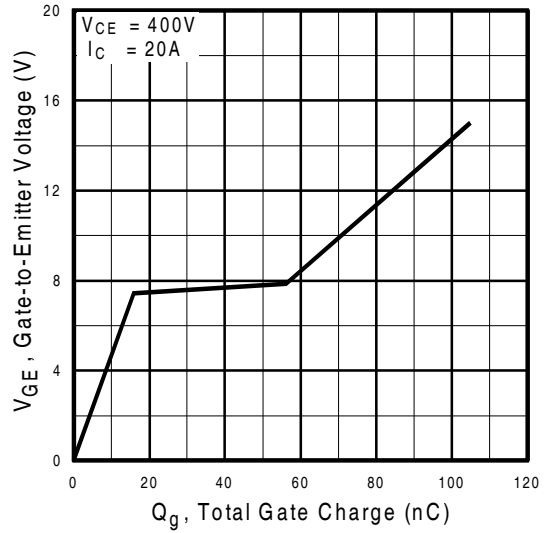
**Fig. 5 - Collector-to-Emitter Voltage vs. Junction Temperature**



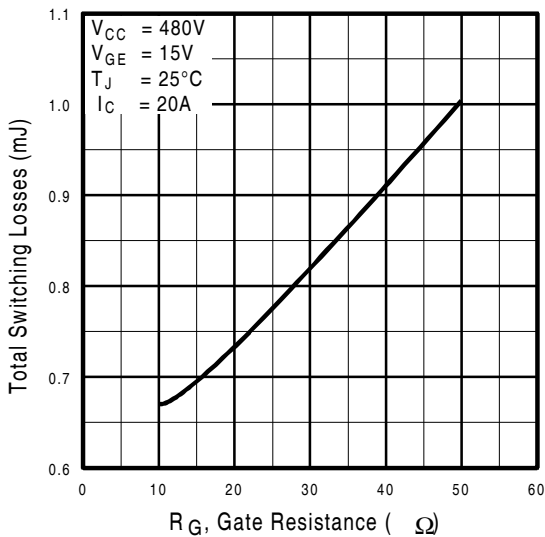
**Fig. 6 - Maximum Effective Transient Thermal Impedance, Junction-to-Case**



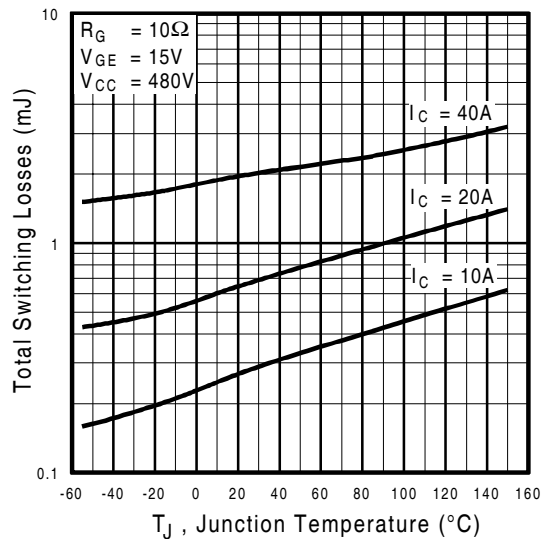
**Fig. 7** - Typical Capacitance vs. Collector-to-Emitter Voltage



**Fig. 8** - Typical Gate Charge vs. Gate-to-Emitter Voltage

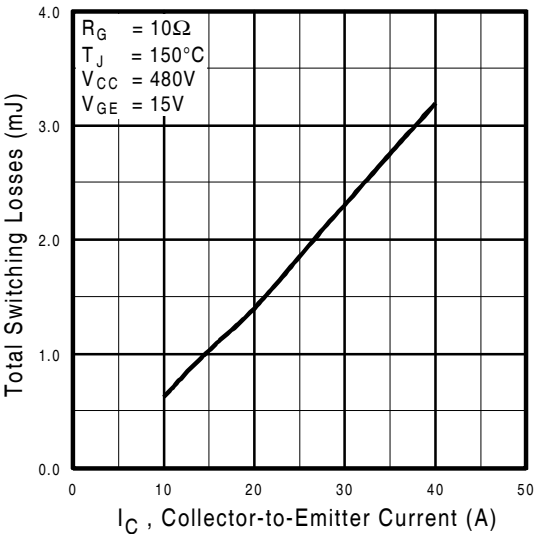


**Fig. 9** - Typical Switching Losses vs. Gate Resistance

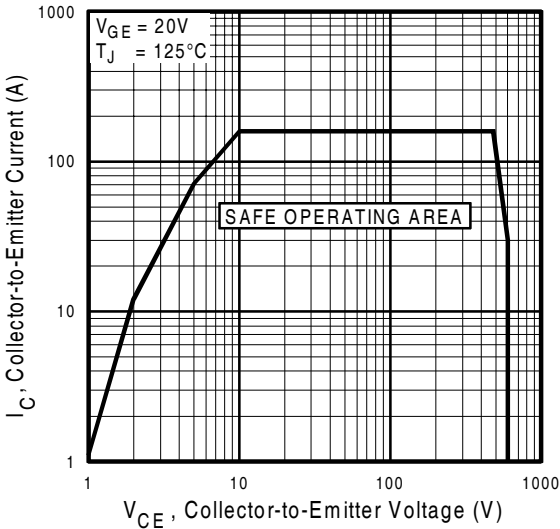


**Fig. 10** - Typical Switching Losses vs. Junction Temperature

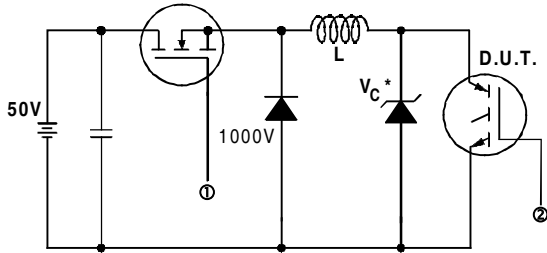
# IRG4PC40UPbF



**Fig. 11** - Typical Switching Losses vs. Collector-to-Emitter Current

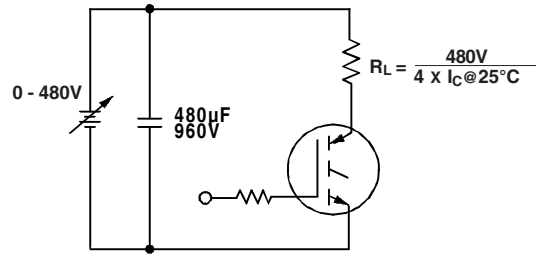


**Fig. 12** - Turn-Off SOA

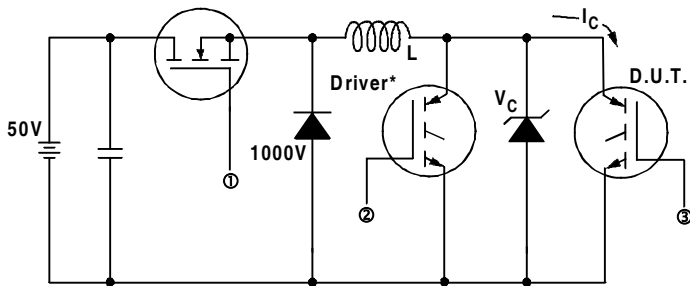


\* Driver same type as D.U.T.;  $V_c = 80\%$  of  $V_{ce(max)}$   
 \* Note: Due to the 50V power supply, pulse width and inductor will increase to obtain rated  $I_d$ .

**Fig. 13a** - Clamped Inductive Load Test Circuit

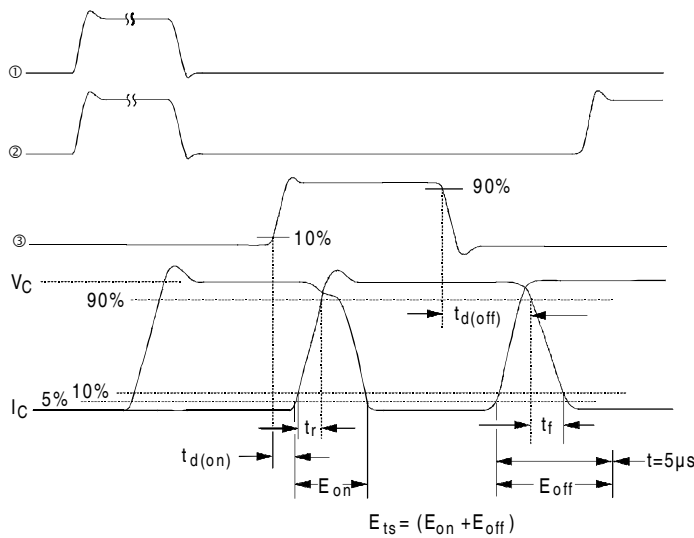


**Fig. 13b** - Pulsed Collector Current Test Circuit



**Fig. 14a** - Switching Loss Test Circuit

\* Driver same type as D.U.T.,  $V_C = 480V$



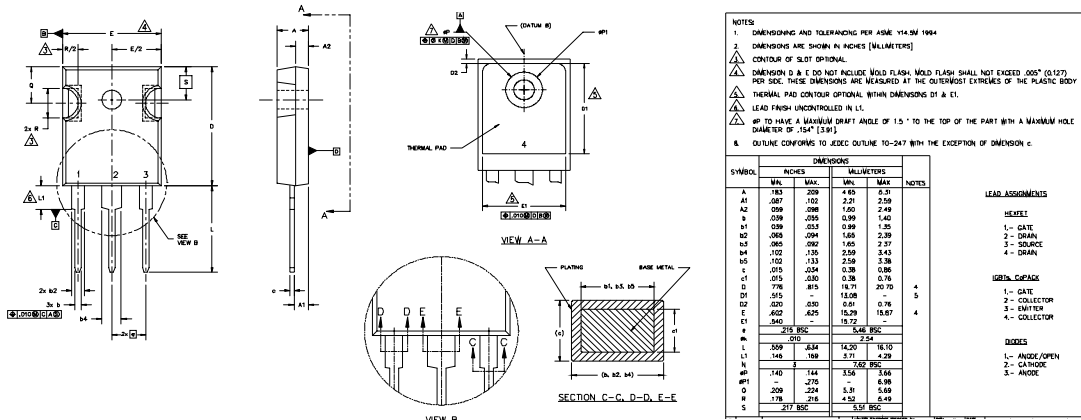
**Fig. 14b** - Switching Loss Waveforms

# IRG4PC40UPbF



## TO-247AC Package Outline

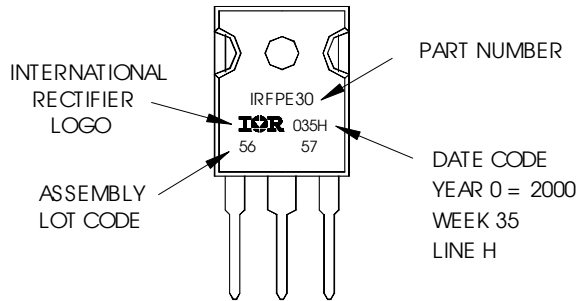
Dimensions are shown in millimeters (inches)



## TO-247AC Part Marking Information

EXAMPLE: THIS IS AN IRFP30  
WITH ASSEMBLY  
LOT CODE 5657  
ASSEMBLED ON WW 35, 2000  
IN THE ASSEMBLY LINE "H"

**Note:** "P" in assembly line position indicates "Lead-Free"



IR WORLD HEADQUARTERS: 233 Kansas St., El Segundo, California 90245, USA Tel: (310) 252-7105  
TAC Fax: (310) 252-7903

Visit us at [www.irf.com](http://www.irf.com) for sales contact information.  
Data and specifications subject to change without notice. 04/04