

### 300MHz Low Power Current Feedback Amplifiers with Enable



The EL5162, EL5163, EL5262, EL5263, and EL5362 are current feedback amplifiers with a bandwidth

of 300MHz. This makes these amplifiers ideal for today's high speed video and monitor applications.

With a supply current of just 1.5mA and the ability to run from a single supply voltage from 5V to 12V, these amplifiers are also ideal for handheld, portable or battery-powered equipment.

The EL5162 also incorporates an enable and disable function to reduce the supply current to 100µA typical per amplifier. Allowing the CE pin to float or applying a low logic level will enable the amplifier.

The EL5162 is available in 6-pin SOT-23 and 8-pin SO packages, the EL5163 in 5-pin SOT-23 and SC-70 packages, the EL5262 in the 10-pin MSOP package, the EL5263 in 8-pin MSOP and SO packages, and the EL5362 in 16-pin SO (0.150") and QSOP packages. All operate over the industrial temperature range of -40°C to +85°C.

### Features

- 500MHz -3dB bandwidth
- 4000V/µs slew rate
- 1.5mA supply current
- Single and dual supply operation, from 5V to 12V supply span
- Fast enable/disable (EL5162, EL5262 & EL5362 only)
- Available in SOT-23 packages
- High speed, 1.4GHz product available (EL5167 & EL5167)
- High speed, 4mA, 630MHz product available (EL5164 & EL5165)

### Applications

- Battery-powered equipment
- Handheld, portable devices
- Video amplifiers
- Cable drivers
- RGB amplifiers
- Test equipment
- Instrumentation
- Current to voltage converters

### Ordering Information

| PART NUMBER  | PACKAGE      | TAPE & REEL  | PKG. DWG. # |
|--------------|--------------|--------------|-------------|
| EL5162IS     | 8-Pin SO     | -            | MDP0027     |
| EL5162IS-T7  | 8-Pin SO     | 7"           | MDP0027     |
| EL5162IS-T13 | 8-Pin SO     | 13"          | MDP0027     |
| EL5162IW-T7  | 6-Pin SOT-23 | 7" (3K pcs)  | MDP0038     |
| EL5162IW-T7A | 6-Pin SOT-23 | 7" (250 pcs) | MDP0038     |
| EL5163IW-T7  | 5-Pin SOT-23 | 7" (3K pcs)  | MDP0038     |
| EL5163IW-T7A | 5-Pin SOT-23 | 7" (250 pcs) | MDP0038     |
| EL5163IC-T7  | 5-Pin SC-70  | 7" (3K pcs)  | P5.049      |
| EL5163IC-T7A | 5-Pin SC-70  | 7" (250 pcs) | P5.049      |
| EL5262IY     | 10-Pin MSOP  | -            | MDP0043     |
| EL5262IY-T7  | 10-Pin MSOP  | 7"           | MDP0043     |
| EL5262IY-T13 | 10-Pin MSOP  | 13"          | MDP0043     |

| PART NUMBER  | PACKAGE            | TAPE & REEL | PKG. DWG. # |
|--------------|--------------------|-------------|-------------|
| EL5263IY     | 8-Pin MSOP         | -           | MDP0043     |
| EL5263IY-T7  | 8-Pin MSOP         | 7"          | MDP0043     |
| EL5263IY-T13 | 8-Pin MSOP         | 13"         | MDP0043     |
| EL5263IS     | 8-Pin SO           | -           | MDP0027     |
| EL5263IS-T7  | 8-Pin SO           | 7"          | MDP0027     |
| EL5263IS-T13 | 8-Pin SO           | 13"         | MDP0027     |
| EL5362IS     | 16-Pin SO (0.150") | -           | MDP0027     |
| EL5362IS-T7  | 16-Pin SO (0.150") | 7"          | MDP0027     |
| EL5362IS-T13 | 16-Pin SO (0.150") | 13"         | MDP0027     |
| EL5362IU     | 16-Pin QSOP        | -           | MDP0040     |
| EL5362IU-T7  | 16-Pin QSOP        | 7"          | MDP0040     |
| EL5362IU-T13 | 16-Pin QSOP        | 13"         | MDP0040     |

Pinouts

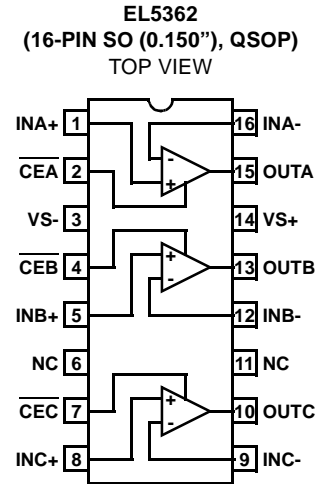
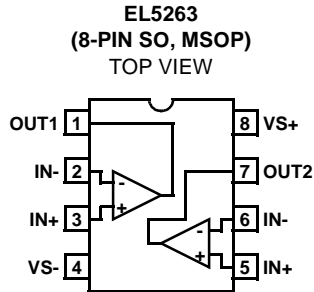
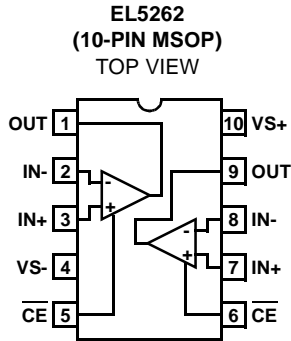
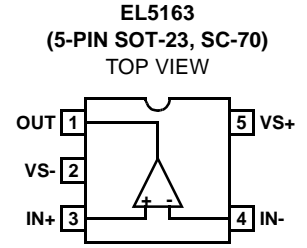
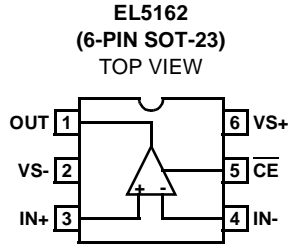
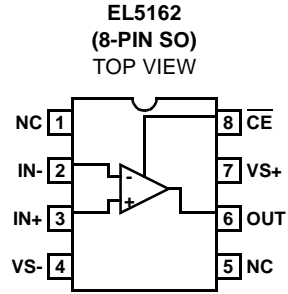

# EL5162, EL5163, EL5262, EL5263, EL5362

## Absolute Maximum Ratings (T<sub>A</sub> = 25°C)

|                                                                            |                                                                       |
|----------------------------------------------------------------------------|-----------------------------------------------------------------------|
| Supply Voltage between V <sub>S+</sub> and V <sub>S-</sub> . . . . . 13.2V | Maximum Voltage between IN+ and IN-, disabled. . . . . ±1.5V          |
| Maximum Continuous Output Current . . . . . 50mA                           | Current into IN+, IN-, CE . . . . . ±5mA                              |
| Operating Junction Temperature . . . . . 125°C                             | Pin Voltages. . . . . V <sub>S-</sub> - 0.5V to V <sub>S+</sub> +0.5V |
| Power Dissipation . . . . . See Curves                                     | Storage Temperature . . . . . -65°C to +150°C                         |
|                                                                            | Ambient Operating Temperature . . . . . -40°C to +85°C                |

*CAUTION: Stresses above those listed in "Absolute Maximum Ratings" may cause permanent damage to the device. This is a stress only rating and operation of the device at these or any other conditions above those indicated in the operational sections of this specification is not implied.*

*IMPORTANT NOTE: All parameters having Min/Max specifications are guaranteed. Typical values are for information purposes only. Unless otherwise noted, all tests are at the specified temperature and are pulsed tests, therefore: T<sub>J</sub> = T<sub>C</sub> = T<sub>A</sub>*

## Electrical Specifications V<sub>S+</sub> = +5V, V<sub>S-</sub> = -5V, R<sub>F</sub> = 750Ω for A<sub>V</sub> = 1, R<sub>F</sub> = 400Ω for A<sub>V</sub> = 2, R<sub>L</sub> = 150Ω, T<sub>A</sub> = 25°C unless otherwise specified.

| PARAMETER                      | DESCRIPTION                                  | CONDITIONS                                                                                           | MIN   | TYP  | MAX   | UNIT   |
|--------------------------------|----------------------------------------------|------------------------------------------------------------------------------------------------------|-------|------|-------|--------|
| <b>AC PERFORMANCE</b>          |                                              |                                                                                                      |       |      |       |        |
| BW                             | -3dB Bandwidth                               | A <sub>V</sub> = +1, R <sub>L</sub> = 500Ω, R <sub>F</sub> = 598Ω                                    |       | 500  |       | MHz    |
|                                |                                              | A <sub>V</sub> = +2, R <sub>L</sub> = 150Ω, R <sub>F</sub> = 422Ω                                    |       | 233  |       | MHz    |
| BW1                            | 0.1dB Bandwidth                              |                                                                                                      |       | 30   |       | MHz    |
| SR                             | Slew Rate                                    | V <sub>O</sub> = -2.5V to +2.5V, A <sub>V</sub> = +2, R <sub>L</sub> = 100Ω (EL5262, EL5263, EL5362) | 2000  | 2500 | 4000  | V/μs   |
|                                |                                              | V <sub>O</sub> = -2.5V to +2.5V, A <sub>V</sub> = +2, R <sub>L</sub> = 100Ω (EL5162, EL51632)        | 2800  | 4000 | 6000  | V/μs   |
| t <sub>S</sub>                 | 0.1% Settling Time                           | V <sub>OUT</sub> = -2.5V to +2.5V, A <sub>V</sub> = +1                                               |       | 25   |       | ns     |
| e <sub>N</sub>                 | Input Voltage Noise                          |                                                                                                      |       | 3    |       | nV/√Hz |
| i <sub>N-</sub>                | IN- Input Current Noise                      |                                                                                                      |       | 10   |       | pA/√Hz |
| i <sub>N+</sub>                | IN+ Input Current Noise                      |                                                                                                      |       | 6.5  |       | pA/√Hz |
| dG                             | Differential Gain Error (Note 1)             | A <sub>V</sub> = +2                                                                                  |       | 0.05 |       | %      |
| dP                             | Differential Phase Error (Note 1)            | A <sub>V</sub> = +2                                                                                  |       | 0.15 |       | °      |
| <b>DC PERFORMANCE</b>          |                                              |                                                                                                      |       |      |       |        |
| V <sub>OS</sub>                | Offset Voltage                               |                                                                                                      | -5    | 1.5  | +5    | mV     |
| T <sub>C</sub> V <sub>OS</sub> | Input Offset Voltage Temperature Coefficient | Measured from T <sub>MIN</sub> to T <sub>MAX</sub>                                                   |       | 6    |       | μV/°C  |
| R <sub>OL</sub>                | Transimpedance                               |                                                                                                      | 500   | 1000 |       | kΩ     |
| <b>INPUT CHARACTERISTICS</b>   |                                              |                                                                                                      |       |      |       |        |
| CMIR                           | Common Mode Input Range                      | Guaranteed by CMRR test                                                                              | ±3    | ±3.3 |       | V      |
| CMRR                           | Common Mode Rejection Ratio                  | V <sub>IN</sub> = ±3V                                                                                | 50    | 62   | 75    | dB     |
| -ICMR                          | - Input Current Common Mode Rejection        |                                                                                                      | -1    | 0.22 | +1    | μA/V   |
| +I <sub>IN</sub>               | + Input Current                              |                                                                                                      | -8    | 0.5  | +8    | μA     |
| -I <sub>IN</sub>               | - Input Current                              |                                                                                                      | -10   | 2    | +10   | μA     |
| R <sub>IN</sub>                | Input Resistance                             |                                                                                                      | 0.8   | 1.6  | 3     | MΩ     |
| C <sub>IN</sub>                | Input Capacitance                            |                                                                                                      |       | 1    |       | pF     |
| <b>OUTPUT CHARACTERISTICS</b>  |                                              |                                                                                                      |       |      |       |        |
| V <sub>O</sub>                 | Output Voltage Swing                         | R <sub>L</sub> = 150Ω to GND                                                                         | ±3.35 | ±3.6 | ±3.75 | V      |
|                                |                                              | R <sub>L</sub> = 1kΩ to GND                                                                          | ±3.75 | ±3.9 | ±4.15 | V      |
| I <sub>OUT</sub>               | Output Current                               | R <sub>L</sub> = 10Ω to GND                                                                          | 60    | 100  |       | mA     |

**EL5162, EL5163, EL5262, EL5263, EL5362**

**Electrical Specifications**  $V_{S+} = +5V$ ,  $V_{S-} = -5V$ ,  $R_F = 750\Omega$  for  $A_V = 1$ ,  $R_F = 400\Omega$  for  $A_V = 2$ ,  $R_L = 150\Omega$ ,  $T_A = 25^\circ C$  unless otherwise specified. **(Continued)**

| PARAMETER                                   | DESCRIPTION                                       | CONDITIONS                           | MIN          | TYP | MAX          | UNIT      |
|---------------------------------------------|---------------------------------------------------|--------------------------------------|--------------|-----|--------------|-----------|
| <b>SUPPLY</b>                               |                                                   |                                      |              |     |              |           |
| $I_{SON}$                                   | Supply Current - Enabled, per Amplifier           | No load, $V_{IN} = 0V$               | 1.3          | 1.5 | 1.7          | mA        |
| $I_{SOFF-}$                                 | Supply Current - Disabled, per Amplifier          | No load, $V_{IN} = 0V$               | -25          | -14 | 0            | $\mu A$   |
| $I_{SOFF+}$                                 |                                                   |                                      | 0            |     | +25          | $\mu A$   |
| PSRR                                        | Power Supply Rejection Ratio                      | DC, $V_S = \pm 4.75V$ to $\pm 5.25V$ | 65           | 76  |              | dB        |
| -IPSR                                       | - Input Current Power Supply Rejection            | DC, $V_S = \pm 4.75V$ to $\pm 5.25V$ | -0.5         | 0.1 | +0.5         | $\mu A/V$ |
| <b>ENABLE (EL5162, EL5262, EL5362 ONLY)</b> |                                                   |                                      |              |     |              |           |
| $t_{EN}$                                    | Enable Time                                       |                                      |              | 380 |              | ns        |
| $t_{DIS}$                                   | Disable Time                                      |                                      |              | 800 |              | ns        |
| $I_{IHCE}$                                  | $\overline{CE}$ Pin Input High Current            | $\overline{CE} = V_{S+}$             | 1            | 15  | 25           | $\mu A$   |
| $I_{ILCE}$                                  | $\overline{CE}$ Pin Input Low Current             | $\overline{CE} = (V_{S+}) - 5V$      | -1           | 0   | +1           | $\mu A$   |
| $V_{IHCE}$                                  | $\overline{CE}$ Input High Voltage for Power-down |                                      | $V_{S+} - 1$ |     |              | V         |
| $V_{ILCE}$                                  | $\overline{CE}$ Input Low Voltage for Power-down  |                                      |              |     | $V_{S+} - 3$ | V         |

NOTE:

1. Standard NTSC test, AC signal amplitude =  $286mV_{p-p}$ ,  $f = 3.58MHz$

Typical Performance Curves

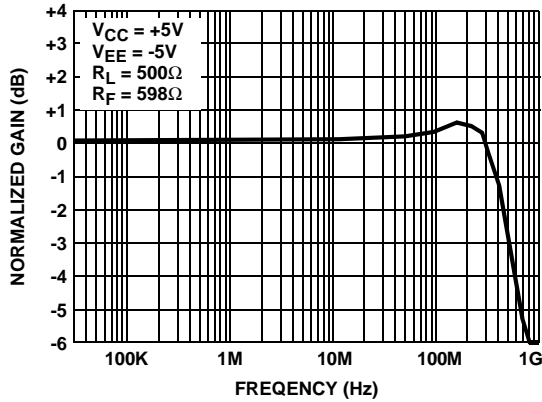

FIGURE 1. FREQUENCY RESPONSE FOR  $A_V = +1$

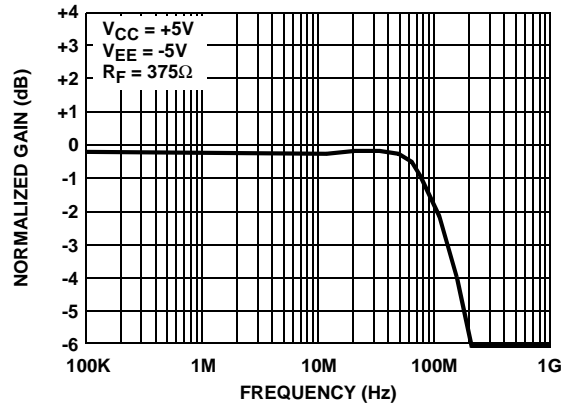

FIGURE 2. FREQUENCY RESPONSE FOR  $A_V = +4.6$

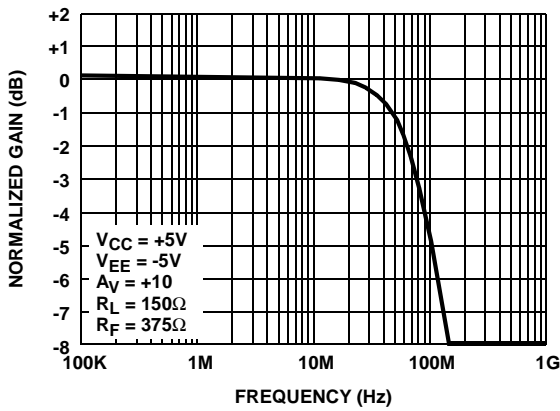

FIGURE 3. FREQUENCY RESPONSE FOR  $A_V = +10$

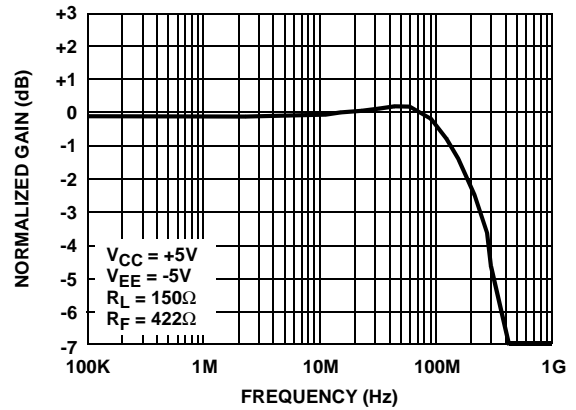

FIGURE 4. FREQUENCY RESPONSE FOR  $A_V = +2$

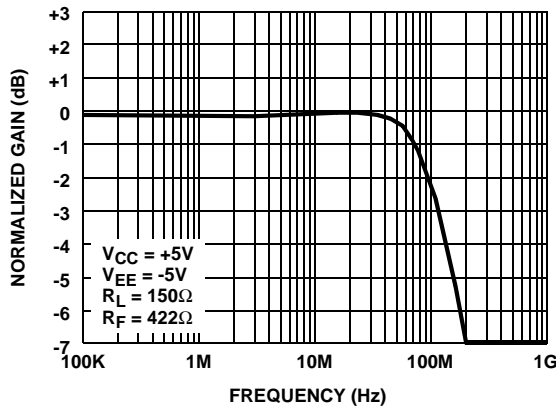

FIGURE 5. FREQUENCY RESPONSE FOR  $A_V = +4$

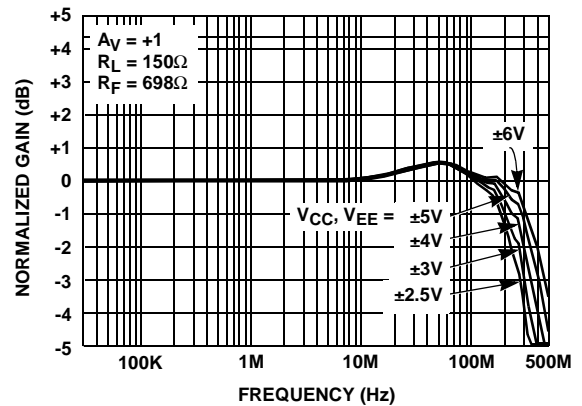

FIGURE 6. FREQUENCY RESPONSE FOR VARIOUS  $V_{CC}, V_{EE}$

Typical Performance Curves (Continued)

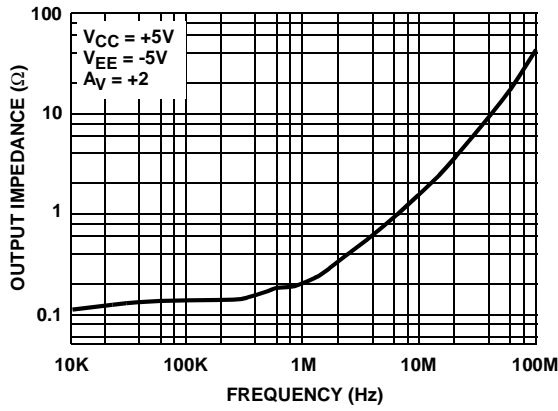

FIGURE 7. CLOSED LOOP OUTPUT IMPEDANCE

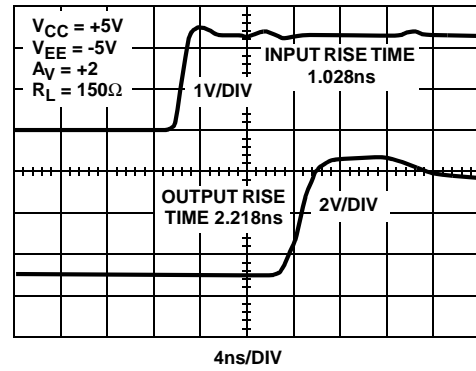

FIGURE 8. EL5262 OUTPUT RISE TIME

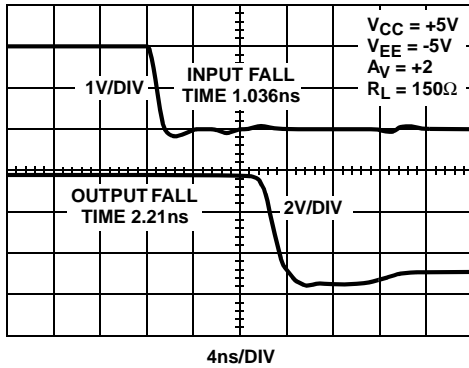

FIGURE 9. EL5262 OUTPUT FALL TIME

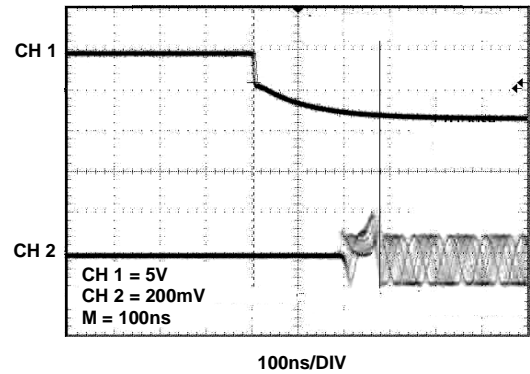

FIGURE 10. TURN ON TIME

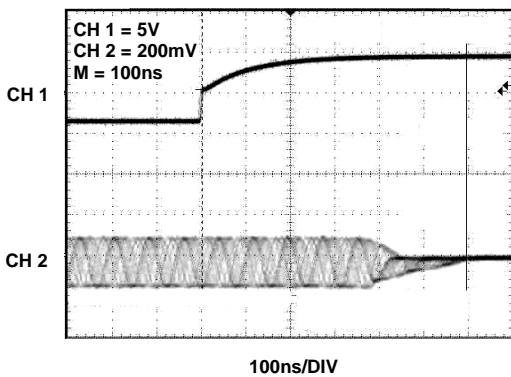

FIGURE 11. TURN OFF TIME

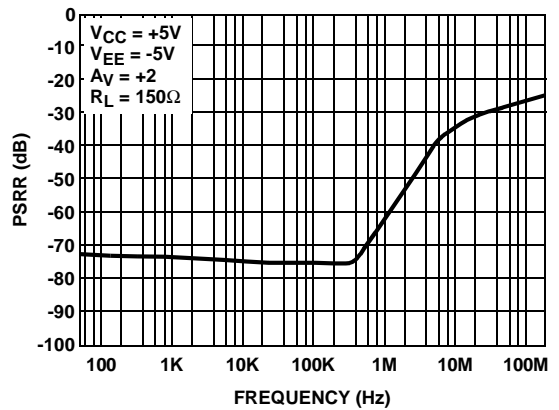

FIGURE 12. PSRR (VCC)

Typical Performance Curves (Continued)

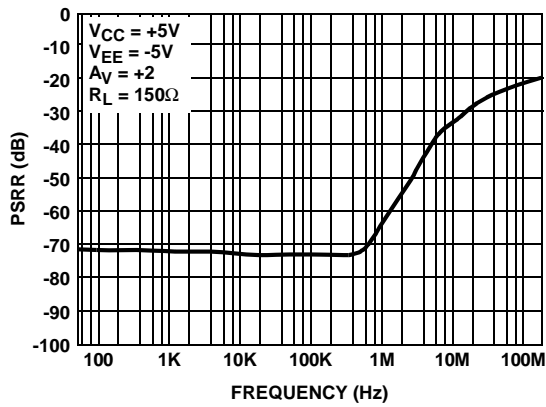

FIGURE 13. PSRR ( $V_{EE}$ )

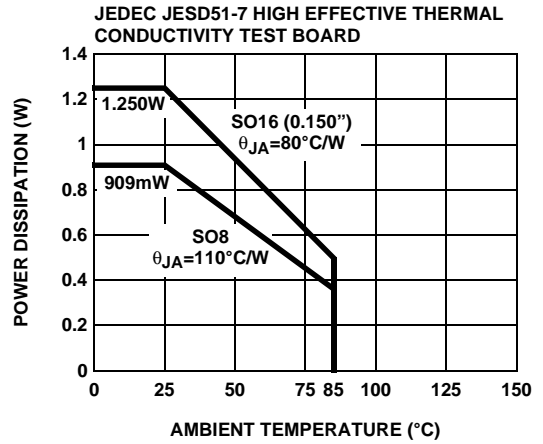

FIGURE 14. PACKAGE POWER DISSIPATION vs AMBIENT TEMPERATURE

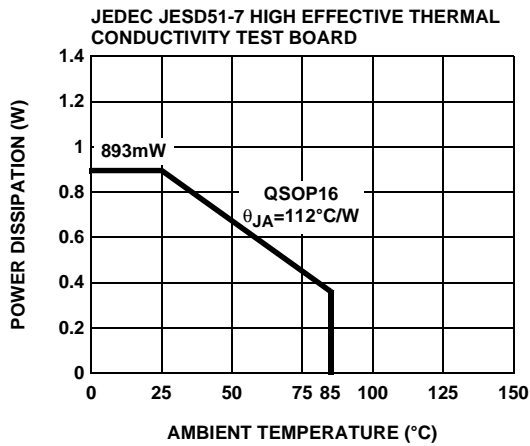

FIGURE 15. PACKAGE POWER DISSIPATION vs AMBIENT TEMPERATURE

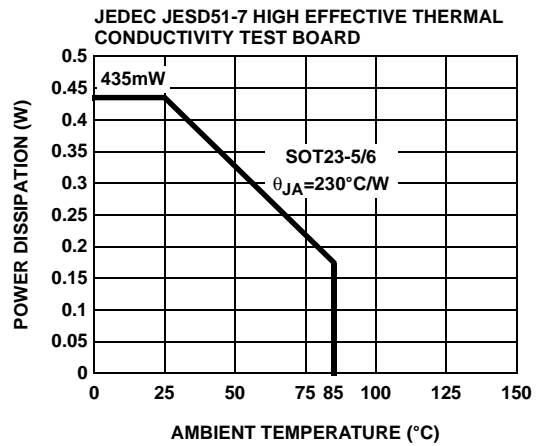

FIGURE 16. PACKAGE POWER DISSIPATION vs AMBIENT TEMPERATURE

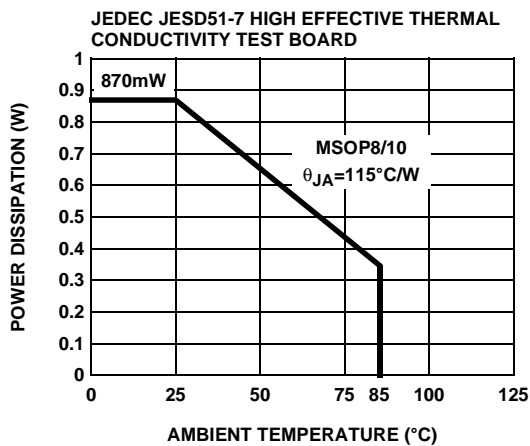

FIGURE 17. PACKAGE POWER DISSIPATION vs AMBIENT TEMPERATURE

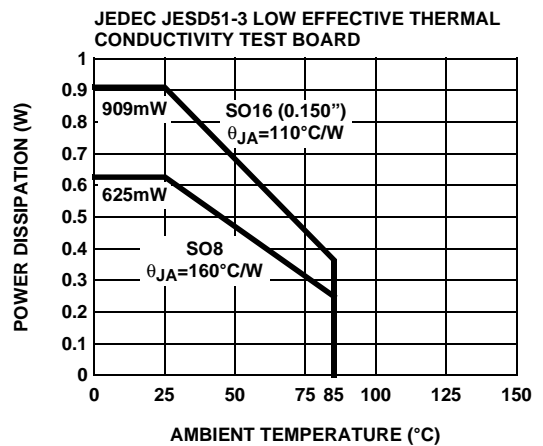

FIGURE 18. PACKAGE POWER DISSIPATION vs AMBIENT TEMPERATURE

Typical Performance Curves (Continued)

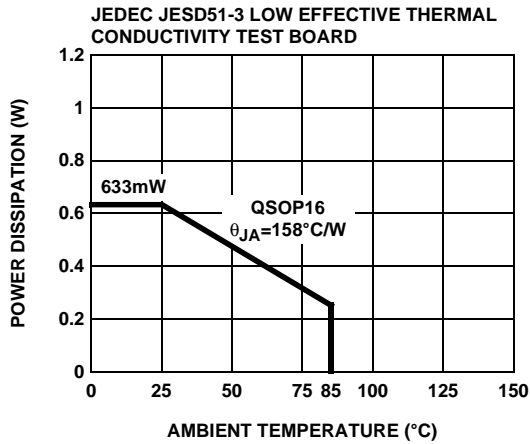

FIGURE 19. PACKAGE POWER DISSIPATION vs AMBIENT TEMPERATURE

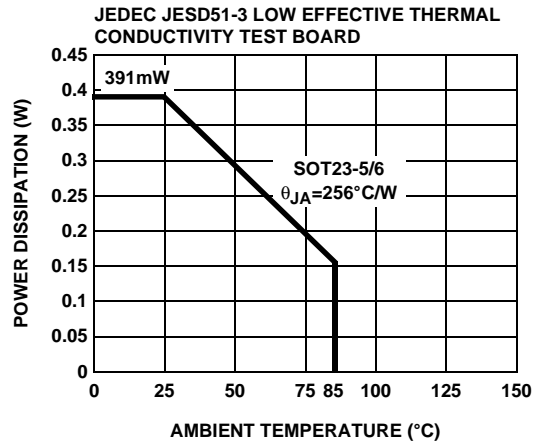

FIGURE 20. PACKAGE POWER DISSIPATION vs AMBIENT TEMPERATURE

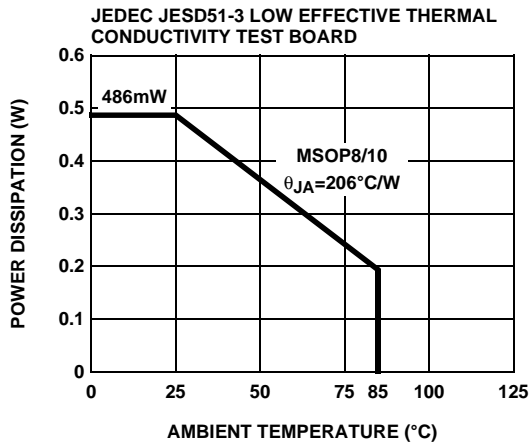

FIGURE 21. PACKAGE POWER DISSIPATION vs AMBIENT TEMPERATURE

All Intersil U.S. products are manufactured, assembled and tested utilizing ISO9000 quality systems. Intersil Corporation's quality certifications can be viewed at [www.intersil.com/design/quality](http://www.intersil.com/design/quality)

*Intersil products are sold by description only. Intersil Corporation reserves the right to make changes in circuit design, software and/or specifications at any time without notice. Accordingly, the reader is cautioned to verify that data sheets are current before placing orders. Information furnished by Intersil is believed to be accurate and reliable. However, no responsibility is assumed by Intersil or its subsidiaries for its use; nor for any infringements of patents or other rights of third parties which may result from its use. No license is granted by implication or otherwise under any patent or patent rights of Intersil or its subsidiaries.*

For information regarding Intersil Corporation and its products, see [www.intersil.com](http://www.intersil.com)