

Technical Data

S1800 / S1803 / S1850 Series

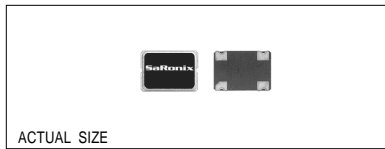

Description

The 5V S1800, S1850 and 3.3V S1803 are crystal-controlled, low-current oscillators providing precise rise and fall times to drive high speed CMOS and TTL loads. The sub-miniature, very low profile leadless ceramic packages have gold-plated contact pads, ideal for today's pick-and-place SMT environments. The S1850 is a high output load version available to 80 MHz.

Applications & Features

- Sub-miniature, 1.1 mm high ceramic package ideal for SMT applications
- 10µA max standby mode on S1800 and S1803
- Available as 3.3V and 5V versions
- CMOS, HCMOS & TTL compatible
- Perfect for PC's; notebook, palmtop computers; portable applications; PCMCIA cards; disc drives. Anywhere small size, low power, surface mountability are a priority
- Available on tape & reel; 16mm tape, 1000pcs per reel

Solder Reflow Guide

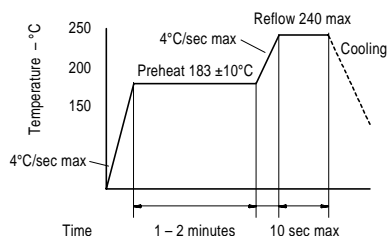

Frequency Range:	1.5440 MHz to 80 MHz			
Frequency Stability:	±25, ±50, ±100 ppm over all conditions; calibration, tolerance, operating temperature, input voltage change, load change, aging (1 Year @ 25°C average ambient temperature), shock and vibration.			
Temperature Range:	Operating: -10 to +70°C or -40 to +85°C Storage: -55 to +125°C			
Supply Voltage:	+5.0V ±10%, 3.3V ±10%			
Supply Current:		S1800	S1803	S1850
1.544 to 32 MHz:	25mA max	15mA max	27mA max	
32+ to 50 MHz:	35mA max	18mA max	35mA max	
50+ to 80 MHz:		25mA max	75mA max	
1.544 to 50 MHz (standby):	10µA max			
1.544 to 80 MHz (standby):		10µA max		
Standby Current:	10µA max on S1800 and S1803 only			
Output:	Symmetry: 45/55% max @ 50% VDD, 40/60% max @ 1.5V on S1800 & 1850			
Rise & Fall Times:	7ns max (10ns max: S1800) 20% to 80% VDD, 1.544 to 50 MHz 5ns max, 50+ to 80 MHz (S1803 & S1850 only)			
Logic 0:	10% VDD max			
Logic 1:	90% VDD min			
Load:	S1800/S1803: 15 pF max, 10 LSTTL S1850: 50 pF max 1.544 to 50 MHz, 10 TTL 30 pF max 50+ to 70 MHz, 10 TTL 20 pF max 70+ to 80 MHz (HCMOS), 10 TTL			
Jitter:	8ps max RMS period jitter			
Mechanical:	Shock: MIL-STD-883, Method 2002, Condition B Solderability: MIL-STD-883, Method 2003 Vibration: MIL-STD-883, Method 2007, Condition A Solvent Resistance: MIL-STD-202, Method 215 Terminal Strength: MIL-STD-883, Method 2004, Condition D Resistance to Soldering Heat: MIL-STD-202, Method 210, Condition I or J			
Environmental:	Gross Leak Test: MIL-STD-883, Method 1014, Condition C Fine Leak Test: MIL-STD-883, Method 1014, Condition A2 Thermal Shock: MIL-STD-883, Method 1011, Condition A Moisture Resistance: MIL-STD-883, Method 1004			

Part Numbering Guide

Saronix **S 1803 C - 60.0000 (T)**

(T) = Tape & Reel full reel increments only

Series

S1800 = 5.0V, 1.544 to 50 MHz, 15 pF, standby
S1803 = 3.3V, 1.544 to 80 MHz, 15 pF, standby
S1850 = 5.0V, 1.544 to 80 MHz, 50 pF high drive

Stability Tolerance

A = ±25 ppm, -10 to +70°C
B = ±50 ppm, -10 to +70°C
C = ±100 ppm, -10 to +70°C
E = ±50 ppm, -40 to +85°C
F = ±100 ppm, -40 to +85°C

Frequency (MHz)

Technical Data

S1800 / S1803 / S1850 Series

Tri-State Logic Table

Pad 1 Input	Pad 3 Output
Logic 1 or NC	Oscillation
Logic 0 or GND	High Impedance

Required Input Levels on Pad 1:
 Logic 1 = 2.2V min
 Logic 0 = 0.8V max

Package Details

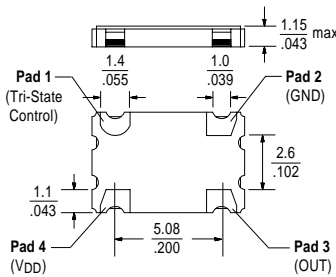
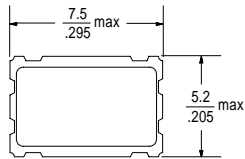

Marking Format*

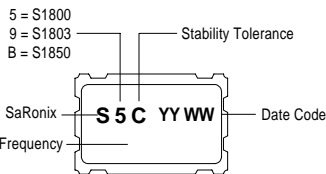

*Exact location of items may vary

Recommended Land Pattern

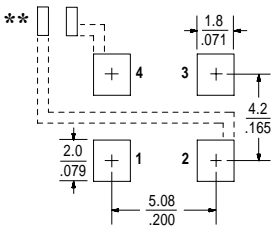

**External high frequency power supply decoupling required.

Scale: None (Dimensions in $\frac{\text{mm}}{\text{inches}}$)

Test Circuit

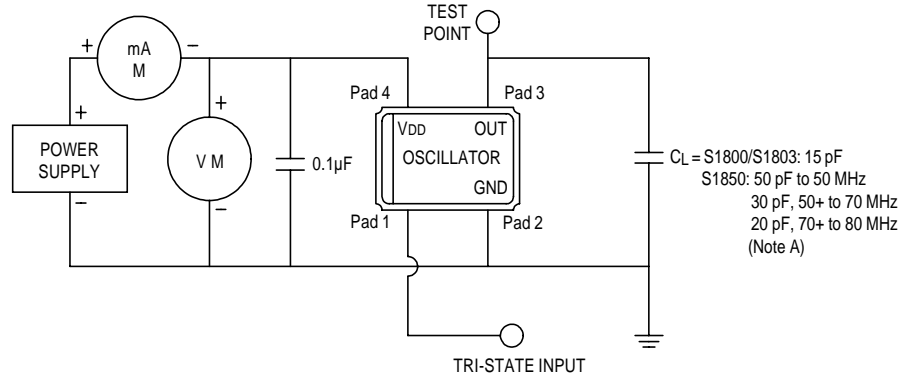

Note A: CL includes probe and fixture capacitance

Output Waveform

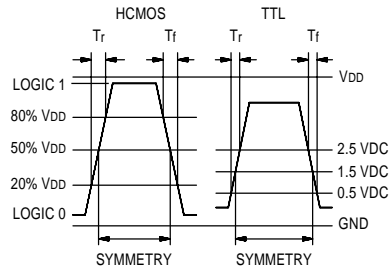

All specifications are subject to change without notice.