



**OptiMOS<sup>®</sup> Power-Transistor**
**Features**

- For fast switching converters and sync. rectification
- N-channel enhancement - logic level
- 175 °C operating temperature
- Avalanche rated
- Pb-free lead plating, RoHS compliant

**Product Summary**

$V_{DS}$	60	V
$R_{DS(on),max}$ SMD version	11	m $\Omega$
$I_D$	78	A

Type	IPB110N06L G	IPP110N06L G
		
<b>Package</b>	PG-TO263-3-2	PG-TO220-3-1
<b>Marking</b>	110N06L	110N06L

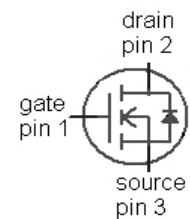
**Maximum ratings, at  $T_j=25\text{ °C}$ , unless otherwise specified**

Parameter	Symbol	Conditions	Value	Unit
Continuous drain current	$I_D$	$T_C=25\text{ °C}$	78	A
		$T_C=100\text{ °C}$	55	
Pulsed drain current	$I_{D,pulse}$	$T_C=25\text{ °C}^{1)}$	312	
Avalanche energy, single pulse	$E_{AS}$	$I_D=78\text{ A}, R_{GS}=25\ \Omega$	280	mJ
Reverse diode $dv/dt$	$dv/dt$	$I_D=78\text{ A}, V_{DS}=48\text{ V},$ $di/dt=200\text{ A}/\mu\text{s},$ $T_{j,max}=175\text{ °C}$	6	kV/ $\mu\text{s}$
Gate source voltage	$V_{GS}$		$\pm 20$	V
Power dissipation	$P_{tot}$	$T_C=25\text{ °C}$	158	W
Operating and storage temperature	$T_j, T_{stg}$		-55 ... 175	$^{\circ}\text{C}$
IEC climatic category; DIN IEC 68-1			55/175/56	

<sup>1)</sup> See figure 3

Parameter	Symbol	Conditions	Values			Unit
			min.	typ.	max.	

**Thermal characteristics**

Thermal resistance, junction - case	$R_{thJC}$		-	-	0.95	K/W
SMD version, device on PCB	$R_{thJA}$	minimal footprint	-	-	62	
		6 cm <sup>2</sup> cooling area <sup>2)</sup>	-	-	40	

**Electrical characteristics, at  $T_j=25\text{ }^\circ\text{C}$ , unless otherwise specified**
**Static characteristics**

Drain-source breakdown voltage	$V_{(BR)DSS}$	$V_{GS}=0\text{ V}, I_D=1\text{ mA}$	60	-	-	V
Gate threshold voltage	$V_{GS(th)}$	$V_{DS}=V_{GS}, I_D=94\text{ }\mu\text{A}$	1.2	1.6	2	
Zero gate voltage drain current	$I_{DSS}$	$V_{DS}=60\text{ V}, V_{GS}=0\text{ V}, T_j=25\text{ }^\circ\text{C}$	-	0.01	1	$\mu\text{A}$
		$V_{DS}=60\text{ V}, V_{GS}=0\text{ V}, T_j=125\text{ }^\circ\text{C}$	-	1	100	
Gate-source leakage current	$I_{GSS}$	$V_{GS}=20\text{ V}, V_{DS}=60\text{ V}$	-	1	100	nA
Drain-source on-state resistance	$R_{DS(on)}$	$V_{GS}=10\text{ V}, I_D=78\text{ A}$	-	8.5	11	m $\Omega$
		$V_{GS}=4.5\text{ V}, I_D=52\text{ A}$	-	10.9	15	
		$V_{GS}=10\text{ V}, I_D=78\text{ A},$ SMD version		8.2	11.0	
		$V_{GS}=4.5\text{ V}, I_D=52\text{ A},$ SMD version		10.6	14.7	
Gate resistance	$R_G$		-	1.9	-	$\Omega$
Transconductance	$g_{fs}$	$ V_{DS} >2 I_D R_{DS(on)max},$ $I_D=78\text{ A}$	47	93	-	S

<sup>2)</sup> Device on 40 mm x 40 mm x 1.5 mm epoxy PCB FR4 with 6 cm<sup>2</sup> (one layer, 70  $\mu\text{m}$  thick) copper area for drain connection. PCB is vertical in still air.

Parameter	Symbol	Conditions	Values			Unit
			min.	typ.	max.	

**Dynamic characteristics**

Input capacitance	$C_{iss}$	$V_{GS}=0\text{ V}, V_{DS}=30\text{ V},$ $f=1\text{ MHz}$	-	2000	2700	pF
Output capacitance	$C_{oss}$		-	470	630	
Reverse transfer capacitance	$C_{rss}$		-	120	180	
Turn-on delay time	$t_{d(on)}$	$V_{DD}=30\text{ V}, V_{GS}=10\text{ V},$ $I_D=78\text{ A}, R_G=3\ \Omega$	-	8	13	ns
Rise time	$t_r$		-	19	29	
Turn-off delay time	$t_{d(off)}$		-	45	68	
Fall time	$t_f$		-	18	27	

**Gate Charge Characteristics<sup>3)</sup>**

Gate to source charge	$Q_{gs}$	$V_{DD}=30\text{ V}, I_D=78\text{ A},$ $V_{GS}=0\text{ to }10\text{ V}$	-	8	11	nC
Gate charge at threshold	$Q_{g(th)}$		-	3	4	
Gate to drain charge	$Q_{gd}$		-	20	30	
Switching charge	$Q_{sw}$		-	25	36	
Gate charge total	$Q_g$		-	59	79	
Gate plateau voltage	$V_{plateau}$		-	4.0	-	V
Output charge	$Q_{oss}$	$V_{DD}=30\text{ V}, V_{GS}=0\text{ V}$	-	19	25	

**Reverse Diode**

Diode continuous forward current	$I_S$	$T_C=25\text{ }^\circ\text{C}$	-	-	78	A
Diode pulse current	$I_{S,pulse}$		-	-	312	
Diode forward voltage	$V_{SD}$	$V_{GS}=0\text{ V}, I_F=78\text{ A},$ $T_J=25\text{ }^\circ\text{C}$	-	0.98	1.3	V
Reverse recovery time	$t_{rr}$	$V_R=30\text{ V}, I_F=I_S,$ $di_F/dt=100\text{ A}/\mu\text{s}$	-	54	67	ns
Reverse recovery charge	$Q_{rr}$		-	61	76	nC

<sup>3)</sup> See figure 16 for gate charge parameter definition

**1 Power dissipation**

$P_{tot}=f(T_C)$

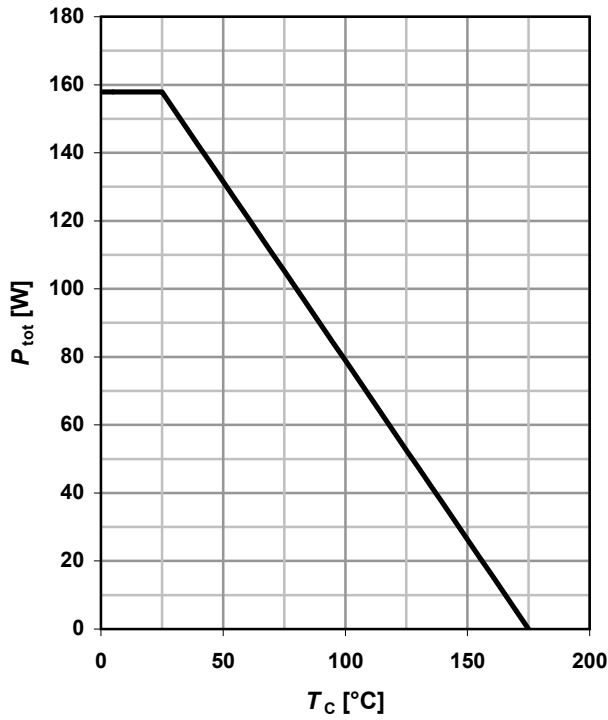

**2 Drain current**

$I_D=f(T_C); V_{GS} \geq 10\text{ V}$

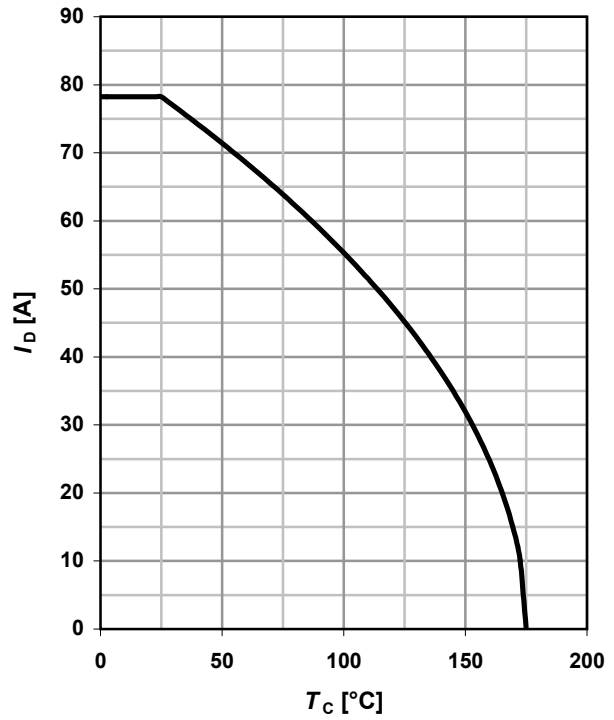

**3 Safe operating area**

$I_D=f(V_{DS}); T_C=25\text{ °C}; D=0$

parameter:  $t_p$

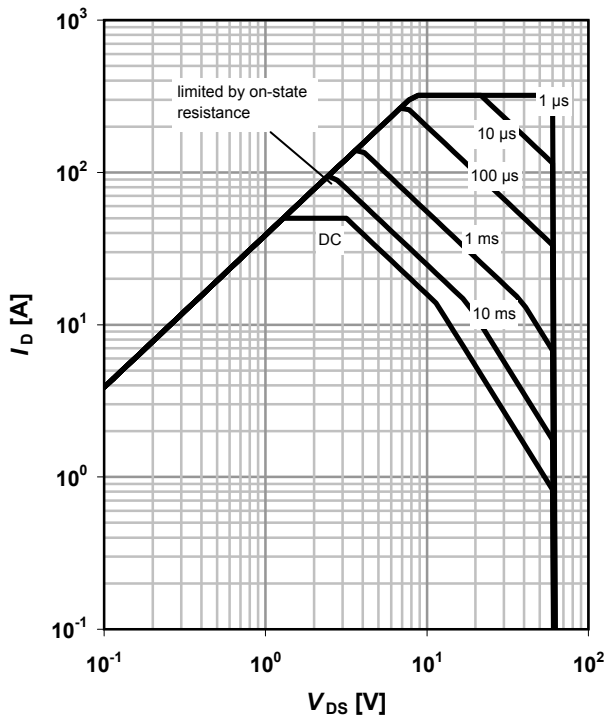

**4 Max. transient thermal impedance**

$Z_{thJC}=f(t_p)$

parameter:  $D=t_p/T$

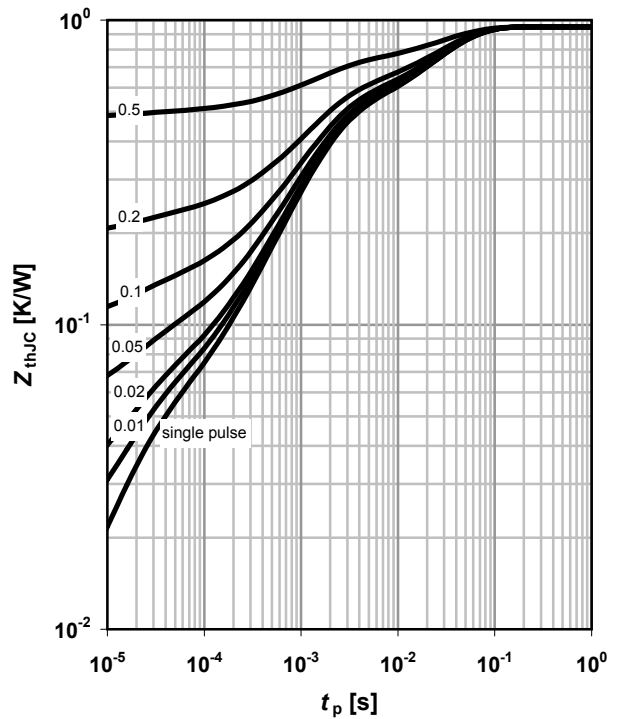

**5 Typ. output characteristics**

$I_D = f(V_{DS}); T_j = 25\text{ }^\circ\text{C}$

parameter:  $V_{GS}$

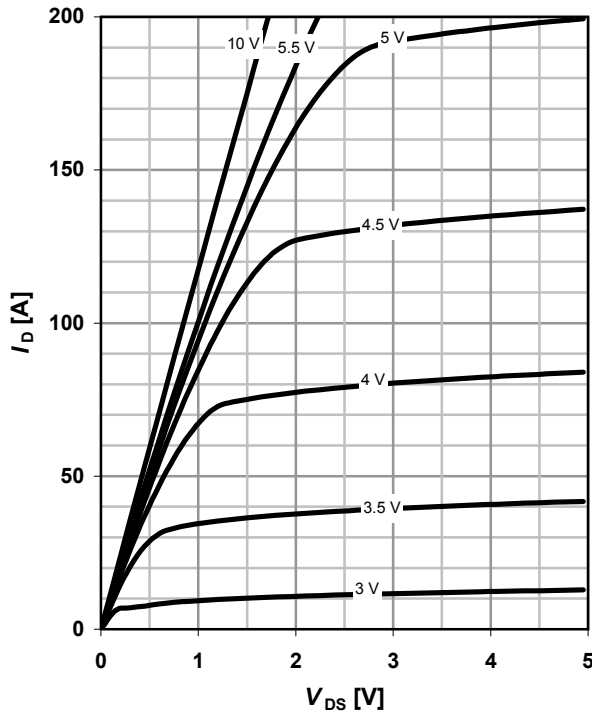

**6 Typ. drain-source on resistance**

$R_{DS(on)} = f(I_D); T_j = 25\text{ }^\circ\text{C}$

parameter:  $V_{GS}$

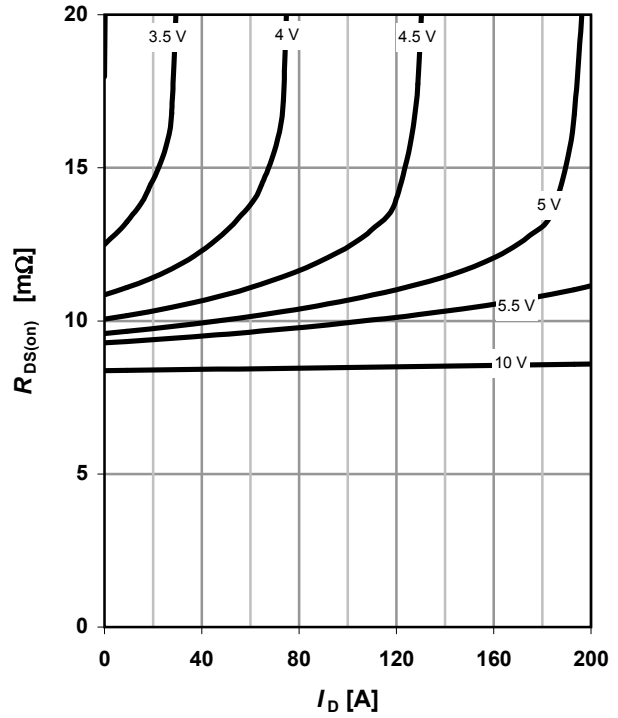

**7 Typ. transfer characteristics**

$I_D = f(V_{GS}); |V_{DS}| > 2|I_D|R_{DS(on)max}$

parameter:  $T_j$

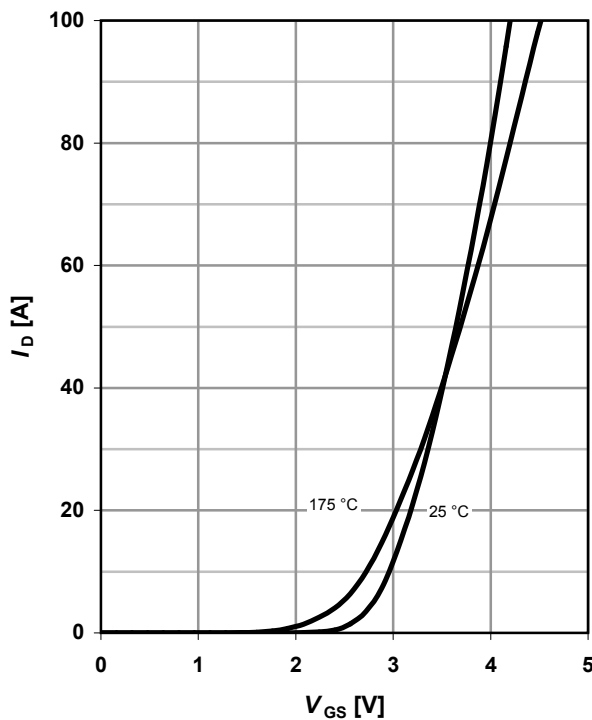

**8 Typ. forward transconductance**

$g_{fs} = f(I_D); T_j = 25\text{ }^\circ\text{C}$

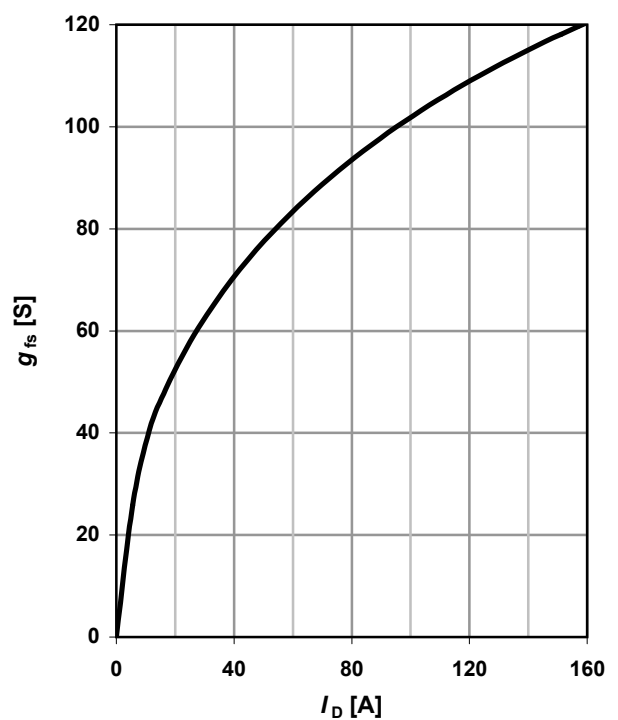

**9 Drain-source on-state resistance**

$R_{DS(on)}=f(T_j); I_D=78\text{ A}; V_{GS}=10\text{ V}$

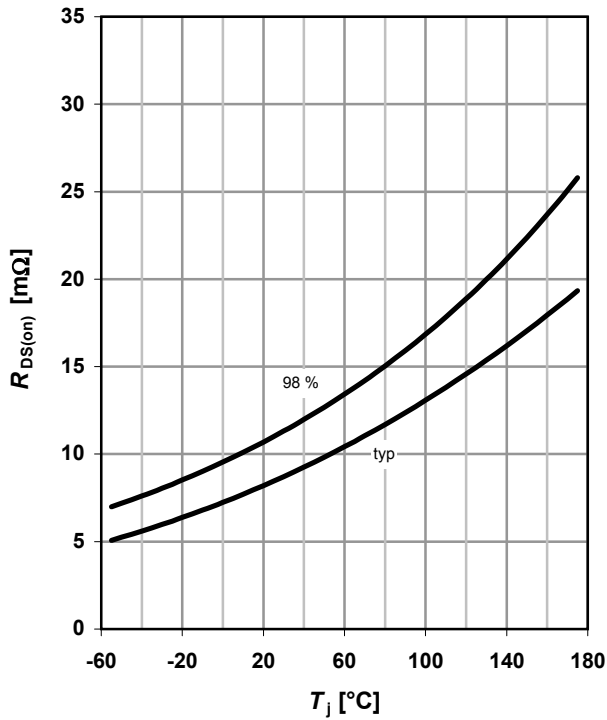

**10 Typ. gate threshold voltage**

$V_{GS(th)}=f(T_j); V_{GS}=V_{DS}$

parameter:  $I_D$

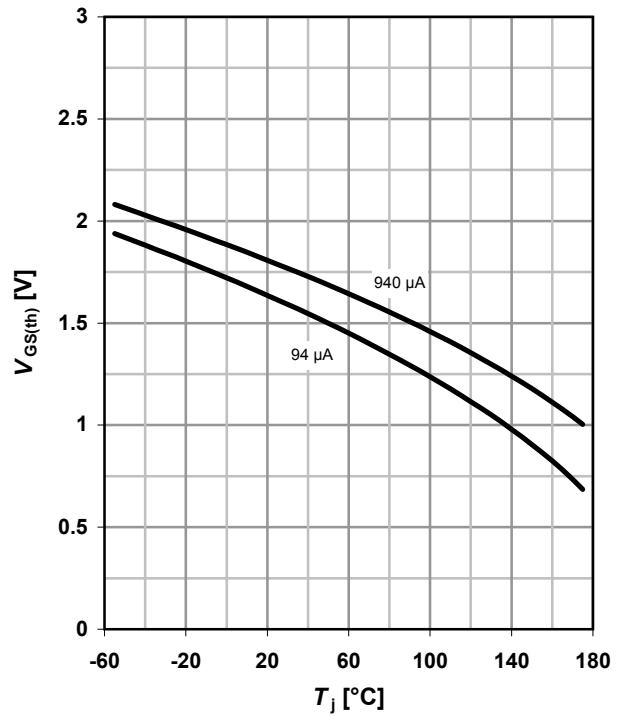

**11 Typ. capacitances**

$C=f(V_{DS}); V_{GS}=0\text{ V}; f=1\text{ MHz}$

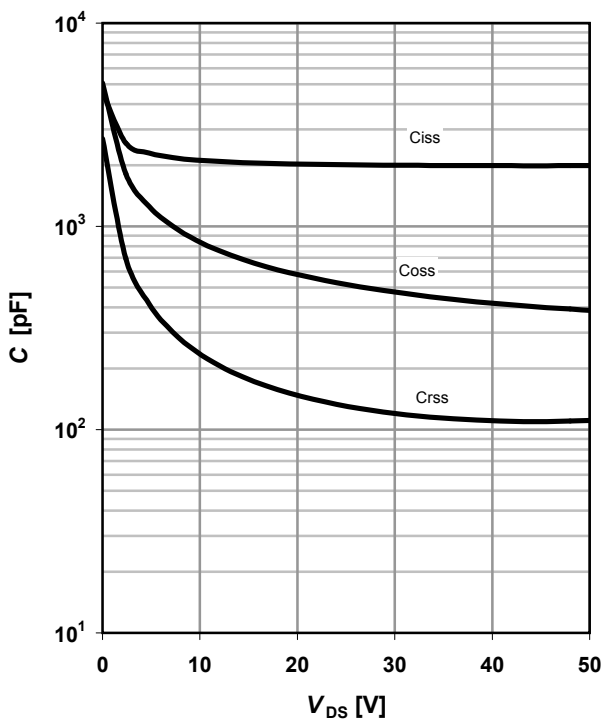

**12 Forward characteristics of reverse diode**

$I_F=f(V_{SD})$

parameter:  $T_j$

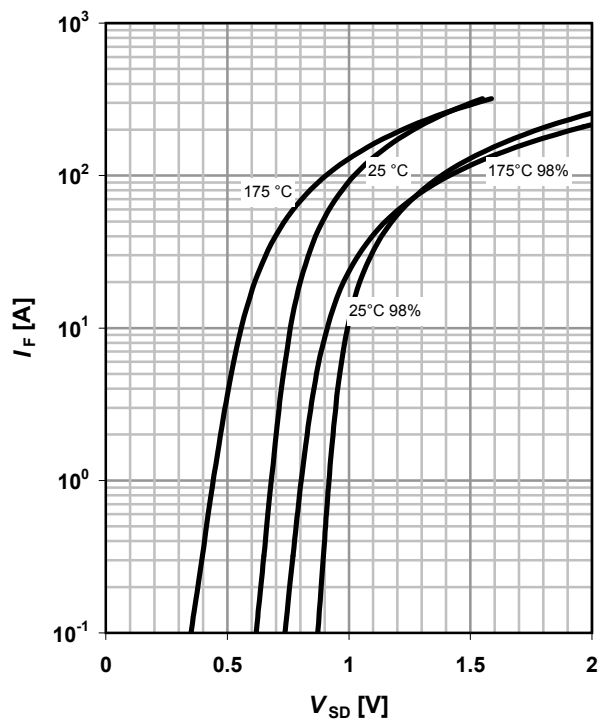

**13 Avalanche characteristics**

$I_{AS}=f(t_{AV}); R_{GS}=25 \Omega$

parameter:  $T_{j(start)}$

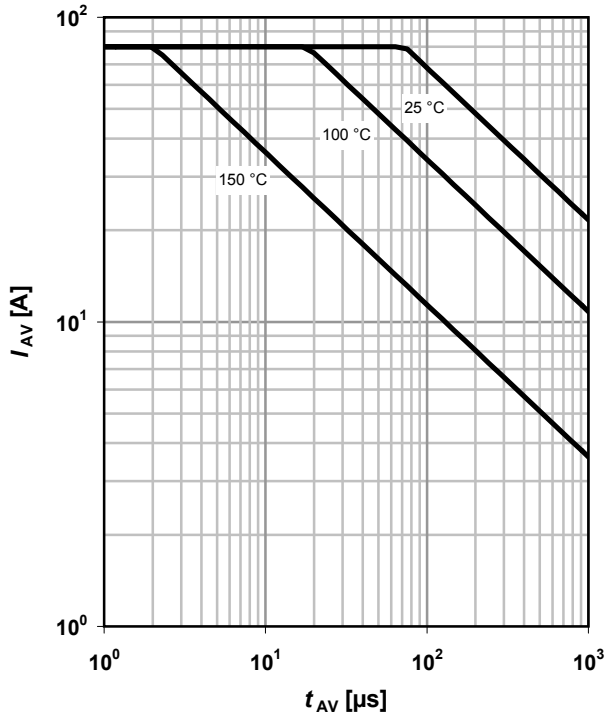

**14 Typ. gate charge**

$V_{GS}=f(Q_{gate}); I_D=78 \text{ A pulsed}$

parameter:  $V_{DD}$

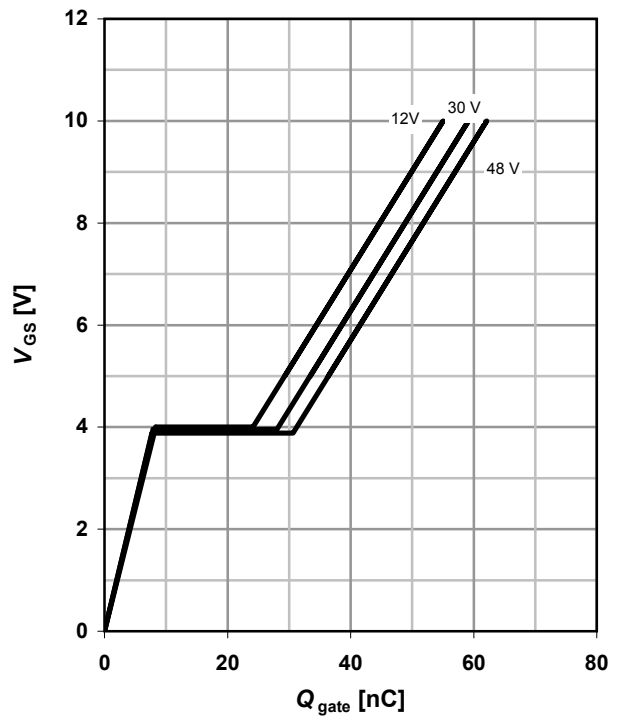

**15 Drain-source breakdown voltage**

$V_{BR(DSS)}=f(T_j); I_D=1 \text{ mA}$

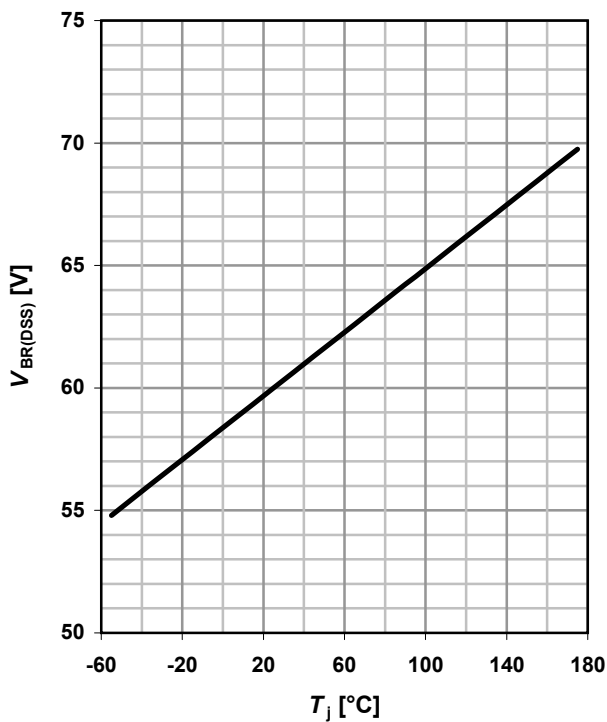

**16 Gate charge waveforms**

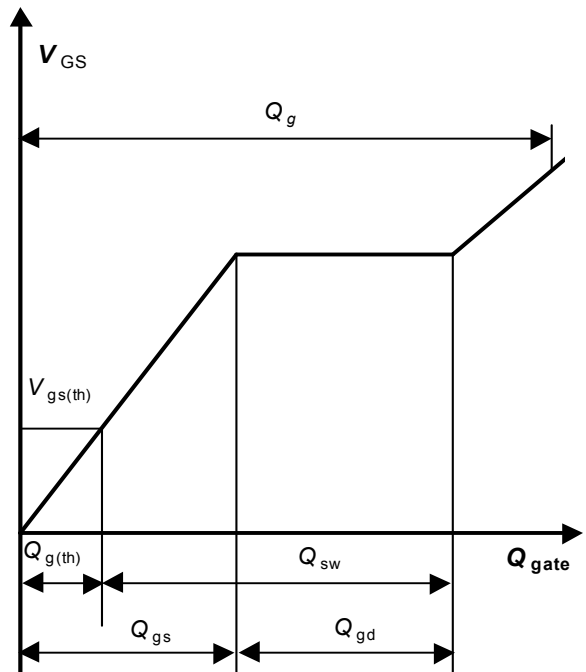

PG-TO-263 (D<sup>2</sup>-Pak)

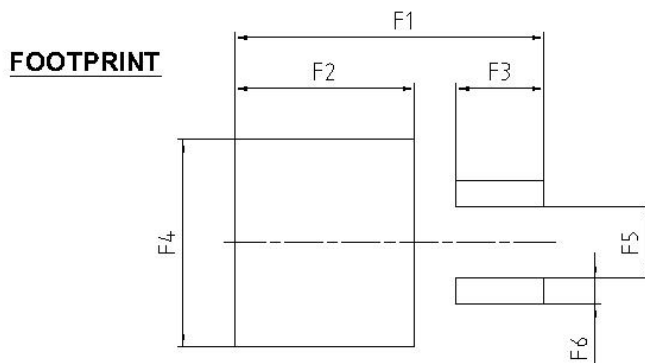
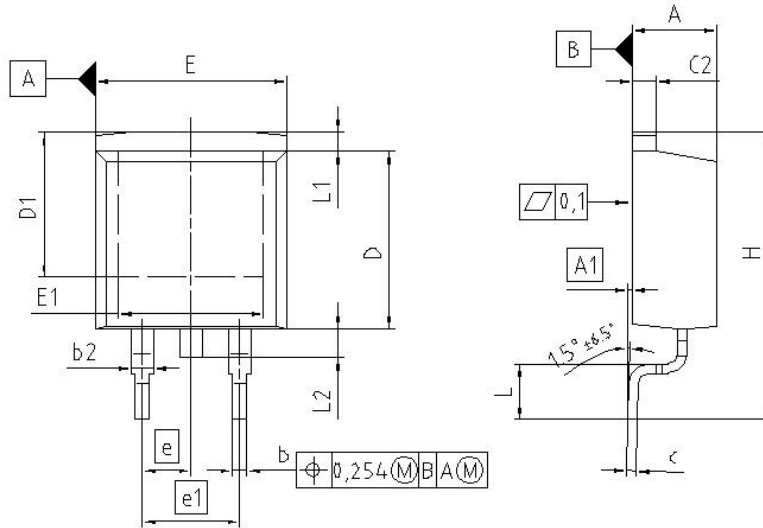

DIM	MILLIMETERS		INCHES	
	MIN	MAX	MIN	MAX
A	4.300	4.572	0.169	0.180
A1	0.000	0.254	0.000	0.010
b	0.850	0.850	0.026	0.033
b2	0.950	1.321	0.037	0.052
c	0.330	0.650	0.013	0.026
c2	0.170	1.400	0.046	0.055
D	8.509	9.450	0.335	0.372
D1	7.100	-	0.280	-
E	9.800	10.312	0.386	0.406
E1	6.500		0.256	
e	2.540		0.100	
e1	5.080		0.200	
N	2		2	
H	14.605	15.875	0.575	0.625
L	2.200	3.000	0.087	0.118
L1	-	1.600	-	0.063
L2	1.000	1.778	0.039	0.070
F1	16.050	16.250	0.632	0.640
F2	9.300	9.500	0.366	0.374
F3	4.500	4.700	0.177	0.185
F4	10.700	10.900	0.421	0.429
F5	3.630	3.830	0.143	0.151
F6	1.100	1.300	0.043	0.051

**REFERENCE**  
JEDEC TO263

**SCALE**

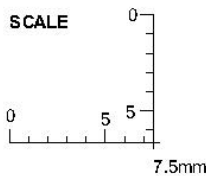

7.5mm

**EUROPEAN PROJECTION**

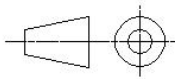

**ISSUE DATE**  
12-02-2006

**FILE**  
TO263\_2

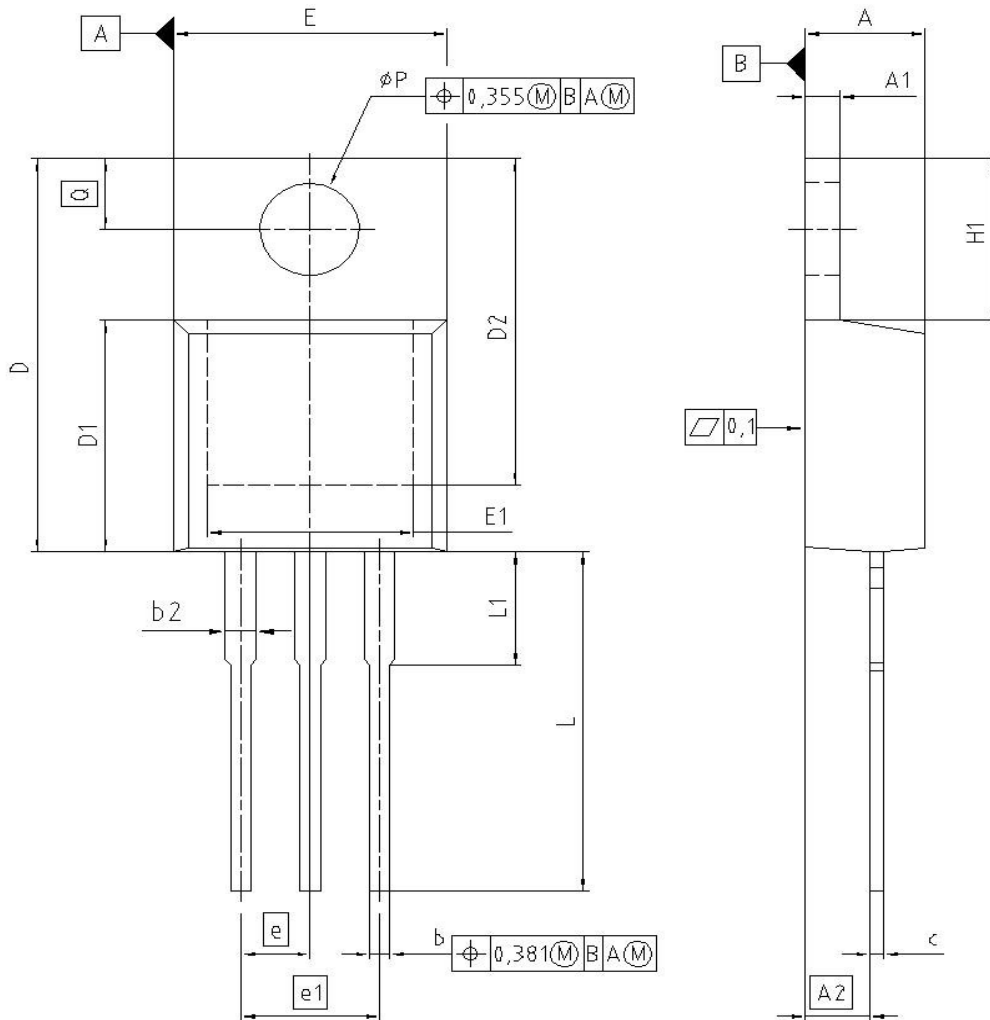

**PG-TO220-3: Outline**

DIM	MILLIMETERS		INCHES	
	MIN	MAX	MIN	MAX
A	4.300	4.572	0.169	0.180
A1	1.170	1.400	0.046	0.055
A2	2.215	2.718	0.087	0.107
b	0.650	0.864	0.026	0.034
b2	0.635	1.778	0.025	0.070
c	0.330	0.600	0.013	0.024
D	14.808	15.950	0.583	0.628
D1	8.509	9.450	0.335	0.372
D2	12.850	13.100	0.506	0.516
E	9.700	10.363	0.382	0.408
E1	6.500	8.600	0.256	0.339
e	2.540		0.100	
e1	5.080		0.200	
N	3		3	
H1	5.900	6.900	0.232	0.272
L	13.000	14.000	0.512	0.551
L1	-	4.800	-	0.189
pP	3.700	3.886	0.146	0.153
Q	2.600	3.000	0.102	0.118

**REFERENCE**  
JEDEC TO220

**SCALE**

**EUROPEAN PROJECTION**

**ISSUE DATE**  
01-06-2005

**FILE**  
TO220\_1

**Published by**  
Infineon Technologies AG  
81726 München, Germany  
© Infineon Technologies AG 2006.  
All Rights Reserved.

**Attention please!**

The information given in this data sheet shall in no event be regarded as a guarantee of conditions or characteristics ("Beschaffenheitsgarantie"). With respect to any examples or hints given herein, any typical values stated herein and/or any information regarding the application of the device, Infineon Technologies hereby disclaims any and all warranties and liabilities of any kind, including without limitation warranties of

**Information**

For further information on technology, delivery terms and conditions and prices please contact your nearest Infineon Technologies Office ([www.infineon.com](http://www.infineon.com)).

**Warnings**

Due to technical requirements components may contain dangerous substances. For information on the types in question please contact your nearest Infineon Technologies Office.

Infineon Technologies Components may only be used in life-support devices or systems with the express written approval of Infineon Technologies, if a failure of such components can reasonably be expected to cause the failure of that life-support device or system, or to affect the safety or effectiveness of that device or system. Life support devices or systems are intended to be implanted in the human body, or to support and/or maintain and sustain and/or protect human life. If they fail, it is reasonable to assume that the health of the user or other persons may be endangered.