

**Features**

- Colorless transparency lens type
- $\phi 5\text{mm}$ (T-13/4) all plastic mold type
- High luminosity

**Outline Dimensions**

**unit : mm**

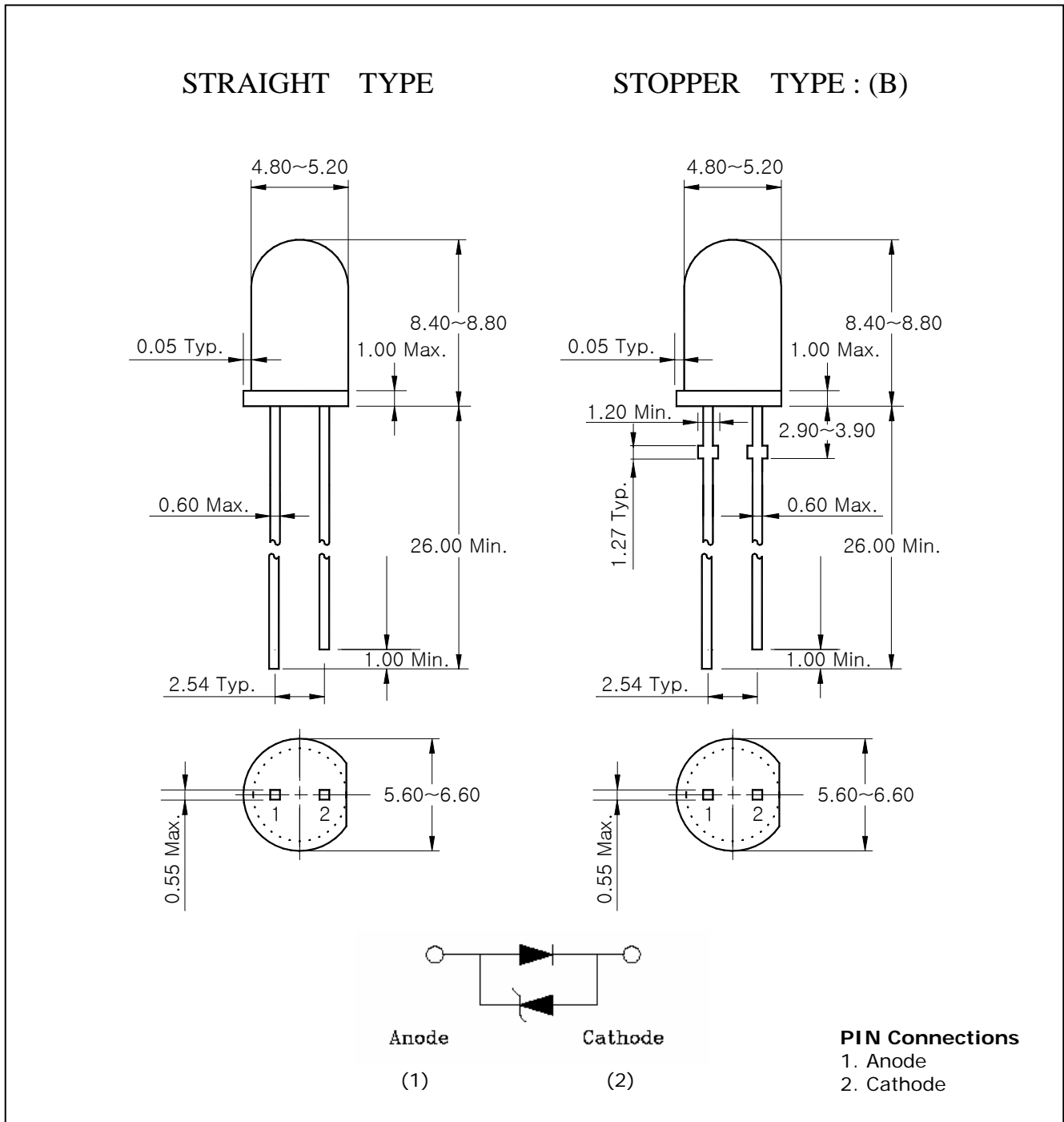

# SW5315E-G / SW5315E-G(B)

## Absolute Maximum Ratings

(Ta=25°C)

Characteristic	Symbol	Rating	Unit
Power dissipation	$P_D$	110	mW
Forward current	$I_F$	30	mA
*1 Peak forward current	$I_{FP}$	50	mA
Operating temperature range	$T_{opr}$	-20 ~ +85	°C
Storage temperature range	$T_{stg}$	-30 ~ +100	°C
*2 Soldering temperature	$T_{sol}$	260°C for 10 seconds	

\*1. Duty ratio = 1/16, Pulse width = 0.1ms

\*2. Keep the distance more than 2.0mm from PCB to the bottom of LED package

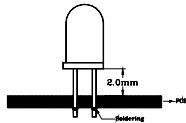

- ※ Recommend document
- . LED is very sensitive to ESD.

## Electrical / Optical Characteristics

(Ta=25°C)

Characteristic	Symbol	Test Condition	Min.	Typ.	Max.	Unit
Forward voltage	$V_F$	$I_F = 20\text{mA}$	2.8	-	3.6	V
*3 Luminous intensity	$I_V$	$I_F = 20\text{mA}$	1760	-	5940	mcd
*4 Chromaticity coordinates	X	$I_F = 20\text{mA}$	0.25	-	0.37	-
	Y		0.21	-	0.40	-
*5 Half angle	$\theta_{1/2}$	$I_F = 20\text{mA}$	-	$\pm 20$	-	deg

\*3. Luminous intensity maximum tolerance for each grade classification limit is  $\pm 18\%$

\*3. Luminous Intensity Classification

S	T	U
1760~2640	2640~3960	3960~5940

\*4. The chromaticity coordinates are derived from the CIE 1931 Chromaticity Diagram and represent the perceived color of the device.

\*5.  $\theta_{1/2}$  is the off-axis angle where the luminous intensity is 1/2 the peak intensity

## Characteristic Diagrams

**Fig. 1  $I_F - V_F$**

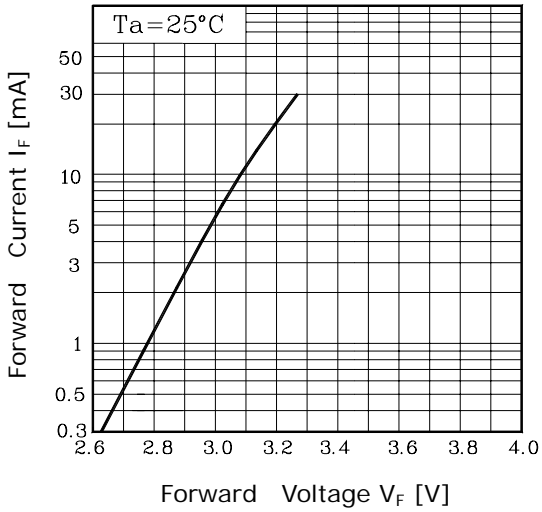

**Fig. 2  $I_V - I_F$**

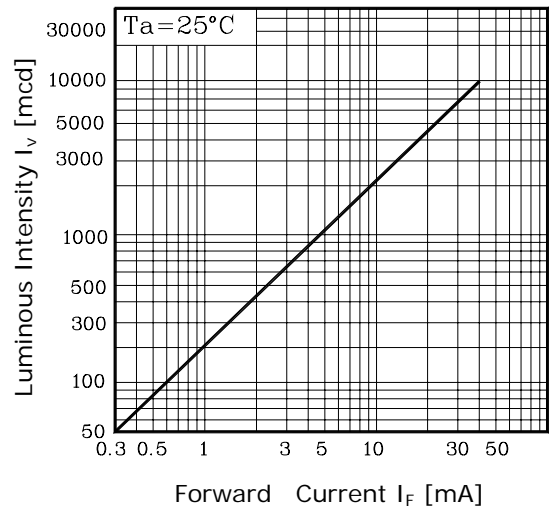

**Fig. 3  $I_F - T_a$**

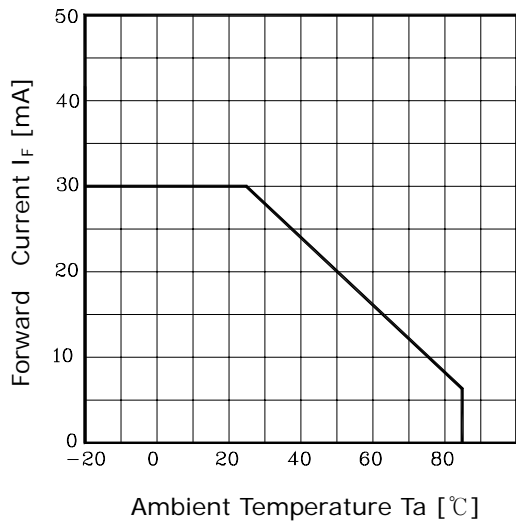

**Fig. 4 Spectrum Distribution**

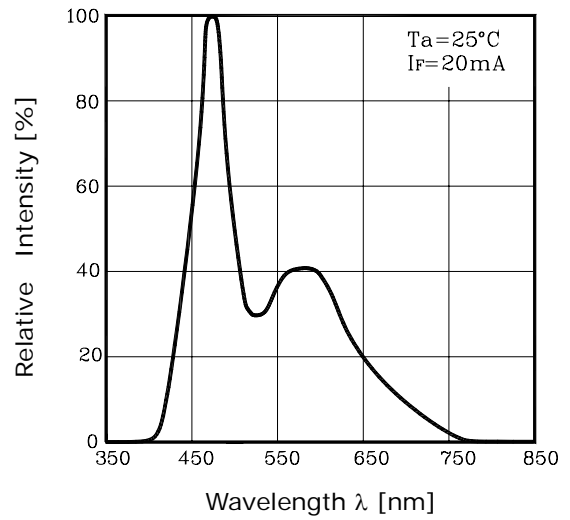

**Fig. 5 Radiation Diagram**

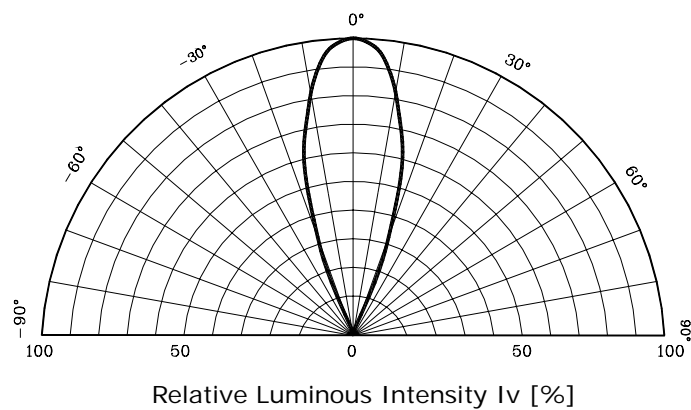

◆ CIE 1931 UCS Diagram

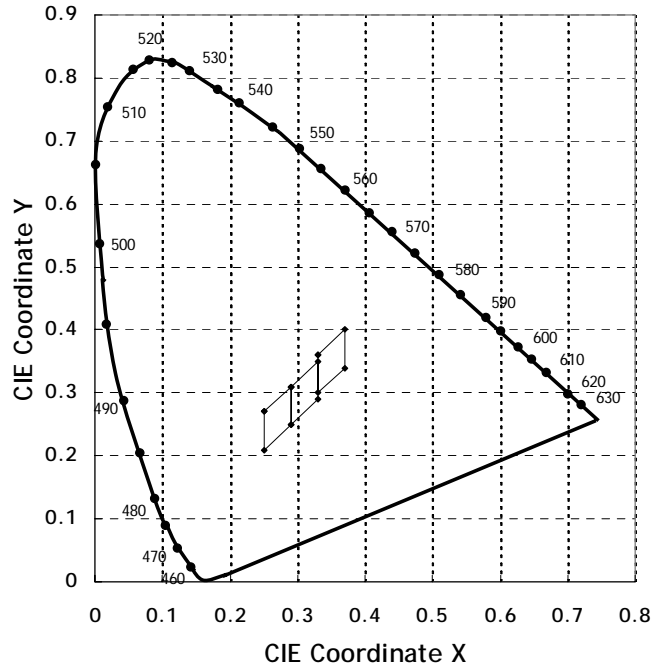
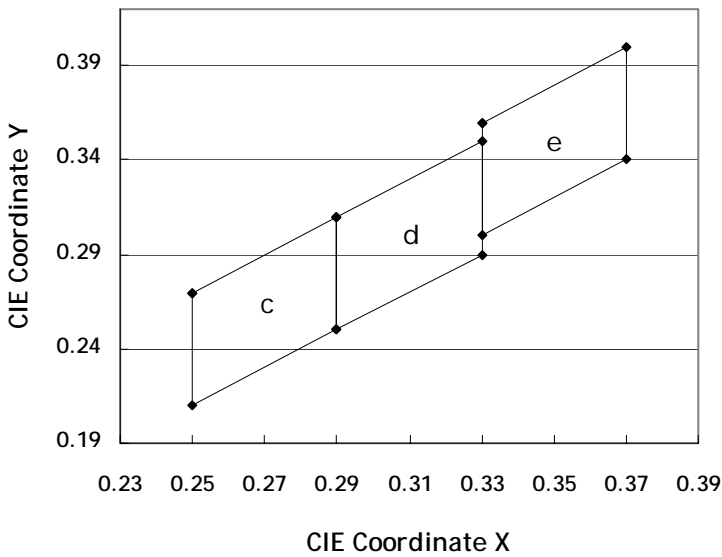

● CIE Coordinates Grade Classification (Ta=25°C, If=20mA)

Color Bin	CIE Coordinates		Color Bin	CIE Coordinates		Color Bin	CIE Coordinates	
	X	Y		X	Y		X	Y
c	0.25	0.27	d	0.29	0.31	e	0.33	0.36
	0.25	0.21		0.29	0.25		0.33	0.30
	0.29	0.25		0.33	0.29		0.37	0.34
	0.29	0.31		0.33	0.35		0.37	0.40

(Do not use to combine grade classification. It must be used separately grade classification)

**The AUK Corp. products are intended for the use as components in general electronic equipment (Office and communication equipment, measuring equipment, home appliance, etc.).**

**Please make sure that you consult with us before you use these AUK Corp. products in equipments which require high quality and / or reliability, and in equipments which could have major impact to the welfare of human life(atomic energy control, airplane, spaceship, transportation, combustion control, all types of safety device, etc.). AUK Corp. cannot accept liability to any damage which may occur in case these AUK Corp. products were used in the mentioned equipments without prior consultation with AUK Corp..**

**Specifications mentioned in this publication are subject to change without notice.**