

### Features

- Glass Passivated Die Construction
- Super-Fast Recovery Time for High Efficiency
- Low Forward Voltage Drop and High Current Capability
- **Lead Free Finish, RoHS Compliant (Note 2)**
- "Green" Molding Compound (No Br, Sb)
- **Qualified to AEC-Q101 Standards for High Reliability**

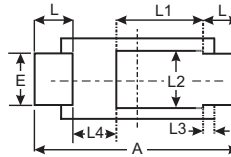
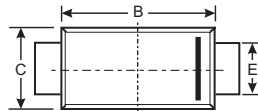
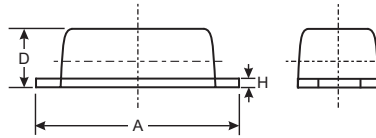

PowerDI™123			
Dim	Min	Max	Typ
A	3.50	3.90	3.70
B	2.60	3.00	2.80
C	1.63	1.93	1.78
D	0.93	1.00	0.98
E	0.85	1.25	1.00
H	0.15	0.25	0.20
L	0.45	0.85	0.65
L1	—	—	1.35
L2	—	—	1.10
L3	—	—	0.20
L4	0.90	1.30	1.05
All Dimensions in mm			

### Mechanical Data

- Case: PowerDI™ 123
- Case Material: Molded Plastic, "Green" Molding Compound. UL Flammability Classification Rating 94V-0
- Moisture Sensitivity: Level 1 per J-STD-020C
- Terminal Connections: Cathode Band
- Terminals: Finish – Matte Tin annealed over Copper leadframe. Solderable per MIL-STD-202, Method 208 (E3)
- Marking & Type Code Information: See Last Page
- Ordering Information: See Last Page
- Weight: 0.01 grams (approximate)

### Maximum Ratings and Electrical Characteristics T<sub>A</sub> = 25°C unless otherwise specified

Single phase, half wave, 60Hz, resistive or inductive load.  
For capacitive load, derate current by 20%.

Characteristic	Symbol	DFLU1400	Unit
Peak Repetitive Reverse Voltage Working Peak Reverse Voltage DC Blocking Voltage	V <sub>RRM</sub> V <sub>RWM</sub> V <sub>R</sub>	400	V
RMS Reverse Voltage	V <sub>R(RMS)</sub>	280	V
Average Rectified Output Current	I <sub>O</sub>	1.0	A
Non-Repetitive Peak Forward Surge Current 8.3ms Single half sine-wave Superimposed on Rated Load	I <sub>FSM</sub>	30	A
Forward Voltage Drop (Note 5) @ I <sub>F</sub> = 1.0A	V <sub>FM</sub>	1.25	V
Peak Reverse Current @ T <sub>A</sub> = 25°C at Rated DC Blocking Voltage (Note 5) @ T <sub>A</sub> = 100°C	I <sub>RM</sub>	5.0 200	μA
Reverse Recovery Time (Note 4)	t <sub>rr</sub>	25	ns
Typical Total Capacitance (f = 1MHz, V <sub>R</sub> = 4VDC)	C <sub>T</sub>	14	pF
Operating and Storage Temperature Range	T <sub>j</sub> , T <sub>STG</sub>	-65 to +150	°C

### Thermal Characteristics @ T<sub>A</sub> = 25°C unless otherwise specified

Characteristic	Symbol	Typ	Max	Unit
Power Dissipation (Note 1)	P <sub>D</sub>	—	1.0	W
Thermal Resistance Junction to Ambient (Note 1)	R <sub>θJA</sub>	117	—	°C/W
Thermal Resistance Junction to Soldering (Note 3)	R <sub>θJS</sub>	—	6	°C/W

- Notes:
1. Device mounted on 1" x 1", Polyimide PCB; 2 oz. Cu pad layout as shown on Diodes Inc. suggested pad layout document AP02001.pdf.
  2. RoHS revision 13.2.2003. Glass and High Temperature Solder Exemptions Applied, see *EU Directive Annex Notes 5 and 7*.
  3. Theoretical R<sub>θJS</sub> calculated from the top center of the die straight down to the PCB cathode tab solder junction.
  4. Measured with I<sub>F</sub> = 0.5A, I<sub>R</sub> = 1.0A, I<sub>rr</sub> = 0.25A. See figure 5.
  5. Short duration pulse test to minimize self-heating effect.

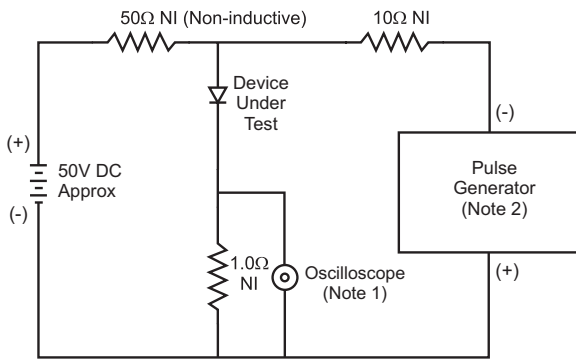
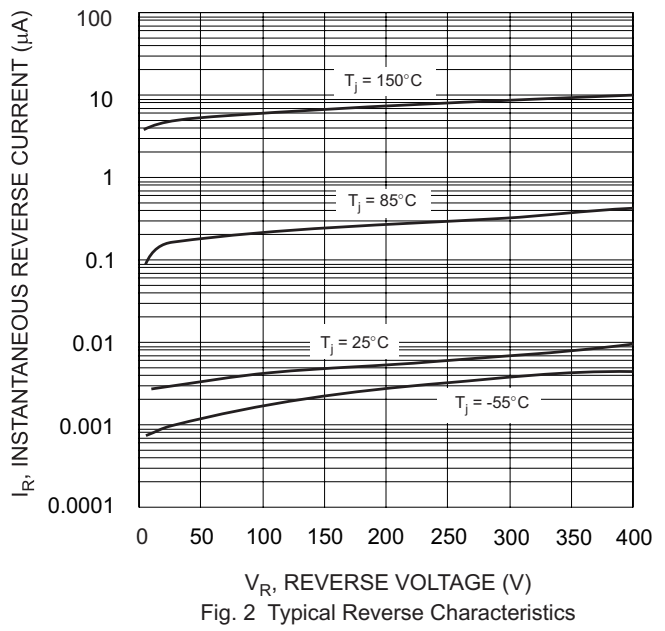
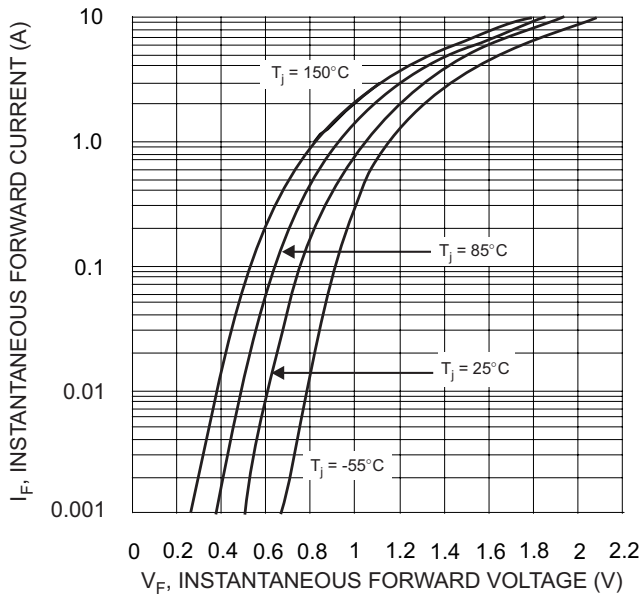

Notes:  
 1. Rise Time = 7.0ns max. Input Impedance = 1.0MΩ, 22pF.  
 2. Rise Time = 10ns max. Input Impedance = 50Ω.

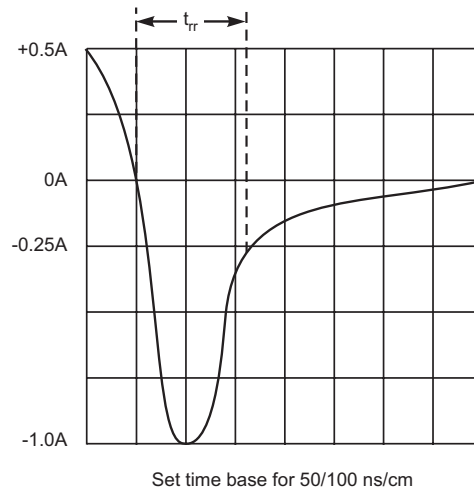
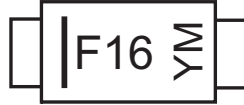

Fig. 3 Reverse Recovery Time Characteristic and Test Circuit

**Ordering Information** (Note 6)

Device	Marking Code	Packaging	Shipping
DFLU1400-7	F16	PowerDI™123	3000/Tape & Reel

Notes: 6. For Packaging Details, go to our website at <http://www.diodes.com/datasheets/ap02007.pdf>.

**Marking Information**

F16 = Product Type Marking Code (See Table Above)  
 YM = Date Code Marking  
 Y = Year (ex: S = 2005)  
 M = Month (ex: 9 = September)

## Date Code Key

Year	2005	2006	2007	2008	2009
Code	S	T	U	V	W

Month	Jan	Feb	March	Apr	May	Jun	Jul	Aug	Sep	Oct	Nov	Dec
Code	1	2	3	4	5	6	7	8	9	O	N	D

**IMPORTANT NOTICE**

Diodes, Inc. and its subsidiaries reserve the right to make changes without further notice to any product herein to make corrections, modifications, enhancements, improvements, or other changes. Diodes, Inc. does not assume any liability arising out of the application or use of any product described herein; neither does it convey any license under its patent rights, nor the rights of others. The user of products in such applications shall assume all risks of such use and will agree to hold Diodes Incorporated and all the companies whose products are represented on our website, harmless against all damages.

**LIFE SUPPORT**

The products located on our website at [www.diodes.com](http://www.diodes.com) are not recommended for use in life support systems where a failure or malfunction of the component may directly threaten life or cause injury without the expressed written approval of Diodes Incorporated.