



3A Low Dropout Regulator with Enable

Features

- 1.5V, 1.8V, 2.5V, 3.3V and Adjustable Outputs
- Over Current and Over Temperature Protection
- Output Current 3A
- Enable Pin
- 20µA Quiescent Current in Shutdown
- TO-263-5 Package

Applications

- Battery Powered Systems
- Motherboards
- Peripheral Cards
- Network Cards
- Set Top Boxes
- Notebook Computers

General Description

The G9966 is a high performance positive voltage regulator designed for use in applications requiring very low dropout voltage at up to 3 Amps. Since it has superior dropout characteristics compared with regular LDOs, it can be used to supply 2.5V on motherboards or 1.5V, 1.8V, 3.3V on peripheral cards from the power supply thus allowing the elimination of costly heatsinks. An enable pin further reduces power dissipation while shut down. The G9966 provides excellent regulation over variations in line, load and temperature. It provides over current and over temperature protection functions.

The G9966 is available with 1.5V, 1.8V, 2.5V, 3.3V and adjustable outputs in TO-263-5 package.

Ordering Information

ORDER NUMBER	MARKING	TEMP. RANGE	PACKAGE (Pb free)
G9966-15TGU	G9966-15	-40°C ~ +85°C	TO-263-5
G9966-18TGU	G9966-18	-40°C ~ +85°C	TO-263-5
G9966-25TGU	G9966-25	-40°C ~ +85°C	TO-263-5
G9966-33TGU	G9966-33	-40°C ~ +85°C	TO-263-5
G9966-ADJTGU	G9966	-40°C ~ +85°C	TO-263-5

Pin Configuration

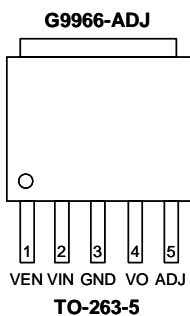
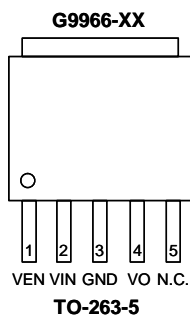

Typical Application Circuit

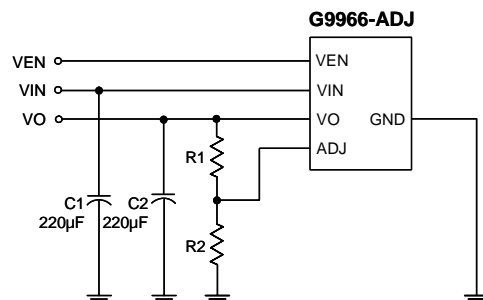
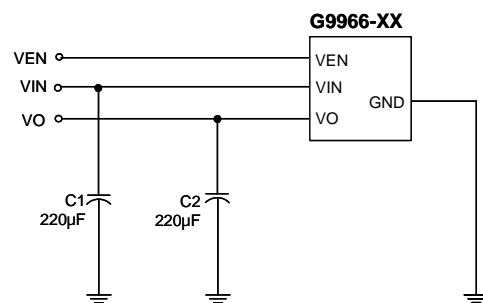

$$VO = \frac{1.2 (R1+R2)}{R2} \text{ Volts}$$

R2=12kΩ is recommended

**Absolute Maximum Ratings** (Note 1)

Input Voltage	7V
V _{EN} Voltage	V _{IN} +0.3V
Power Dissipation Internally Limited	(Note 2)
Maximum Junction Temperature	150°C
Storage Temperature	
Range	-65°C ≤ T _J ≤ +150°C
Reflow Temperature (soldering, 10sec)	260°C
Thermal Resistance Junction to Ambient, (θ _{JA})	
TO-263-5 ⁽¹⁾	70°C/W
Thermal Resistance Junction to Case, (θ _{JC})	
TO-263-5	5°C/W
ESD Rating (Human Body Model)	2kV

Operation Conditions (Note 1)

Input Voltage	2.2V ~5.5V
Temperature Range	-40°C ≤ T _A ≤ +85°C

Note ⁽¹⁾: See Recommended Minimum Footprint

Electrical Characteristics

V_{EN} = V_{IN}, V_{IN} = 5V, I_O = 0.5A, C_{IN} = C_{OUT} = 220μF, T_A = T_J = 25°C unless otherwise specified (Note 3)

PARAMETER	SYMBOL	CONDITION	MIN	TYP	MAX	UNIT
Supply Voltage	V _{IN}		2.2	---	5.5	V
Output Voltage	V _O	V _{IN} = V _O + 0.7V, I _O = 10mA	-2	V _O	2	%
Line Regulation		V _O + 0.7V ≤ V _{IN} ≤ 5.5V, I _O = 10mA	---	0.3	2	%
Load Regulation		G9966-15 V _{IN} = 2.5V, 10mA ≤ I _{OUT} ≤ 3A	---	1	2	%
		G9966-18 V _{IN} = 3.8V, 10mA ≤ I _{OUT} ≤ 3A				
		G9966-25 V _{IN} = 5V, 10mA ≤ I _{OUT} ≤ 3A				
		G9966-33 V _{IN} = 5V, 10mA ≤ I _{OUT} ≤ 3A				
Quiescent Current	I _Q	V _{IN} = 5V	---	3	10	mA
Ripple Rejection		f _i = 120Hz, 1V _{P-P} , I _O = 100mA	---	55	---	dB
Dropout Voltage	V _D	G9966-15 ΔV _{OUT} = 2%, I _{OUT} = 3A	---	0.85	1	V
		G9966-18 ΔV _{OUT} = 2%, I _{OUT} = 3A	---	0.8	0.95	
		G9966-25 ΔV _{OUT} = 2%, I _{OUT} = 3A	---	0.6	0.8	
		G9966-33 ΔV _{OUT} = 2%, I _{OUT} = 3A	---	0.55	0.7	
Short Circuit Current			---	1	---	A
Over Temperature			---	150	---	°C
V _{EN} Voltage High	V _{ENH}	Output Active	1.6	---	---	V
V _{EN} Voltage Low	V _{ENL}	Output Disabled	---	---	0.4	V
V _{EN} Bias Current Low	I _{ENL}	V _{EN} = 0.4V	---	---	20	μA
Shutdown Current		V _{IN} = 5V, V _{EN} = 0V	---	20	35	μA
ADJ Reference Voltage	V _{REF}	V _{IN} = 2.2V, V _{ADJ} = V _{OUT} , I _O = 10mA	1.176	1.2	1.224	V
ADJ Pin Threshold			---	0.2	---	V

Note 1: Absolute Maximum Ratings are limits beyond which damage to the device may occur. Operating Conditions are conditions under which the device functions but the specifications might not be guaranteed. For guaranteed specifications and test conditions see the Electrical Characteristics.

Note2: The maximum power dissipation is a function of the maximum junction temperature, T_{Jmax}; total thermal resistance, θ_{JA}, and ambient temperature T_A. The maximum allowable power dissipation at any ambient temperature is (T_{Jmax} - T_A) / θ_{JA}. If this dissipation is exceeded, the die temperature will rise above 150°C and IC will go into thermal shutdown.

Note3: Low duty pulse techniques are used during test to maintain junction temperature as close to ambient as possible.



Definitions

Dropout Voltage

The input/output voltage differential at which the regulator output no longer maintains regulation against further reductions in input voltage. Measured when the output drops 2% below its nominal value, dropout voltage is affected by junction temperature, load current and minimum input supply requirements.

Line Regulation

The change in output voltage for a change in input voltage. The measurement is made under conditions of low dissipation or by using pulse techniques such that average chip temperature is not significantly affected.

Load Regulation

The change in output voltage for a change in load current at constant chip temperature. The measurement is made under conditions of low dissipation or by using pulse techniques such that average chip temperature is not significantly affected.

Maximum Power Dissipation

The maximum total device dissipation for which the regulator will operate within specifications.

Quiescent Bias Current

Current which is used to operate the regulator chip and is not delivered to the load.

Typical Performance Characteristics

$V_{IN}-V_{OUT}=3V$, $C_{IN}=220\mu F$, $C_{OUT}=220\mu F$, $T_A=25^\circ C$, unless otherwise noted.

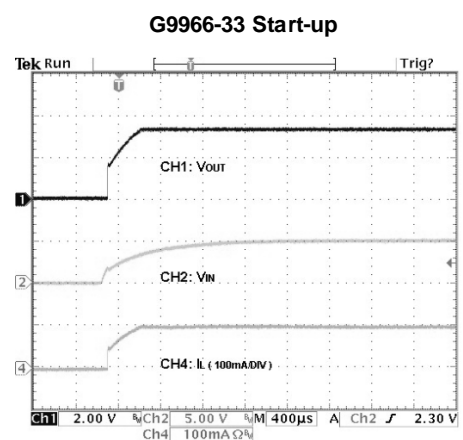
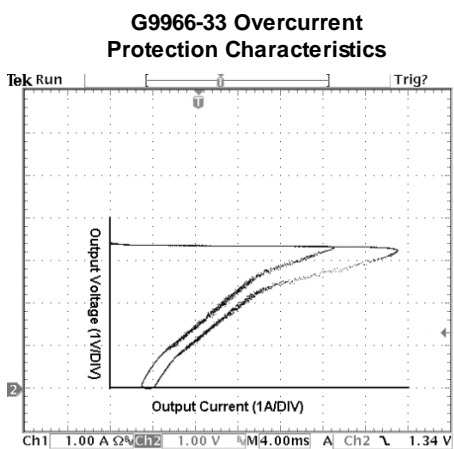
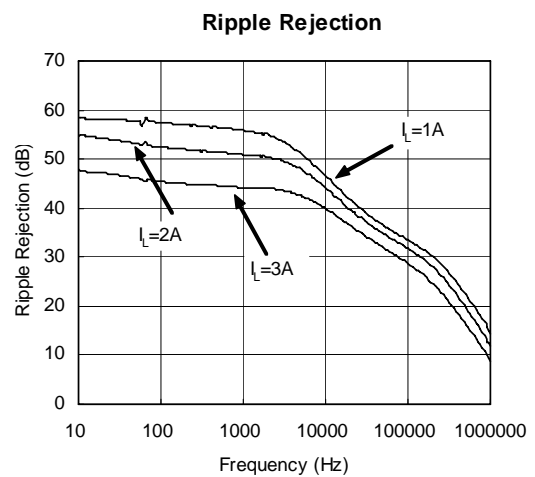
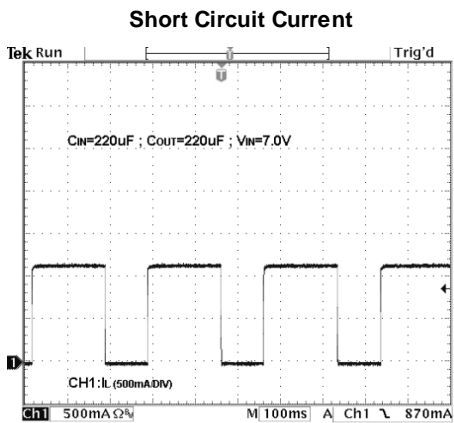
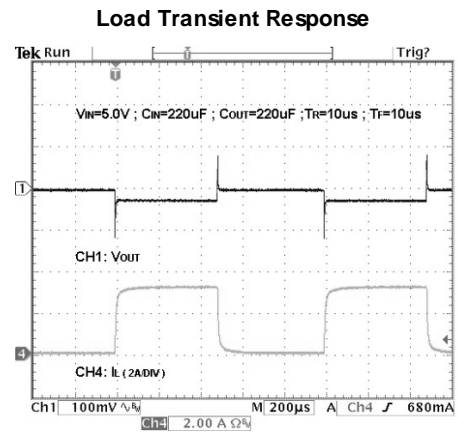
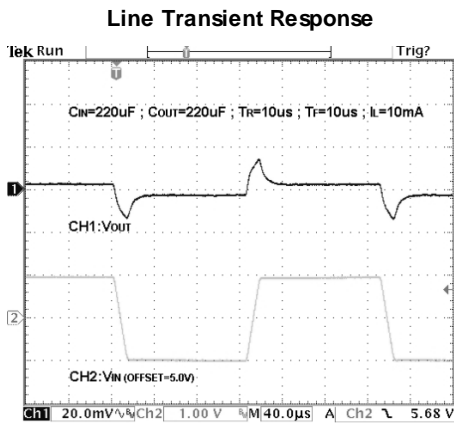

Typical Performance Characteristics (continued)

G9966-33 Start-up

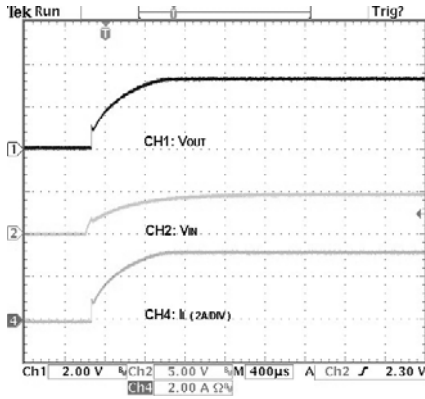

G9966-18 Overcurrent Protection Characteristics

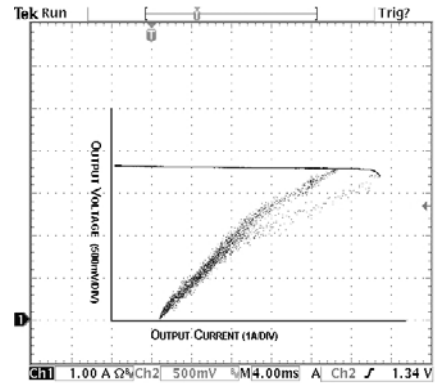

G9966-18-Start-up

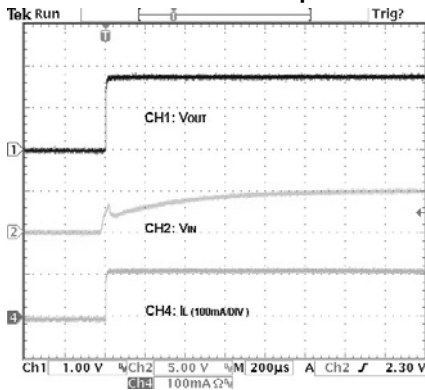

G9966-18-Start-up

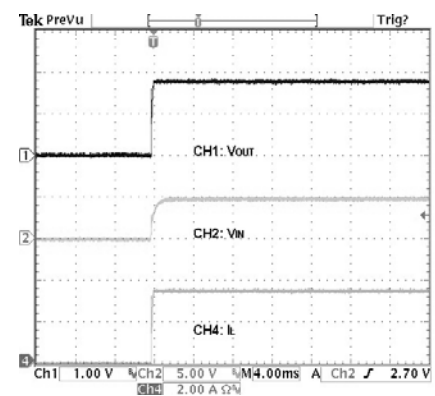

G9966 Max. Power Dissipation vs. PCB Top Copper Area

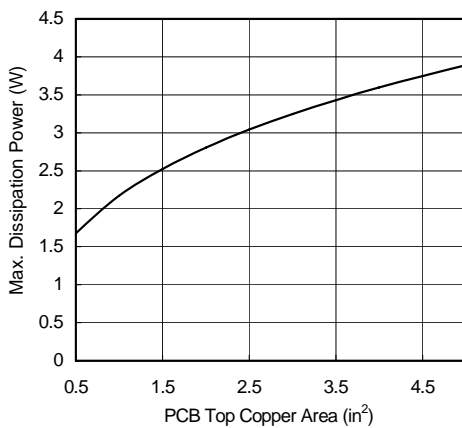

G9966 Max. Power Dissipation vs. T_{AMB}

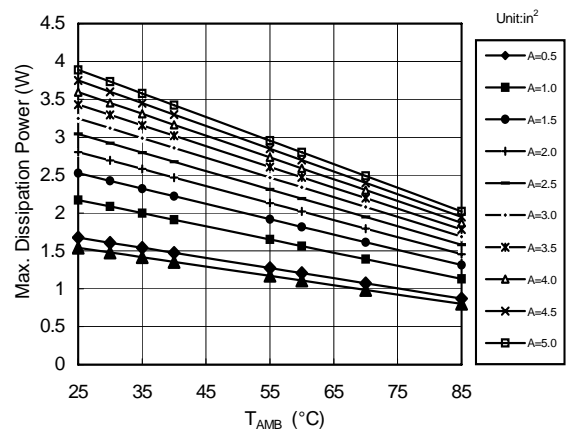

Typical Performance Characteristics (continued)

G9966-18 Quiescent Current vs. Temperature

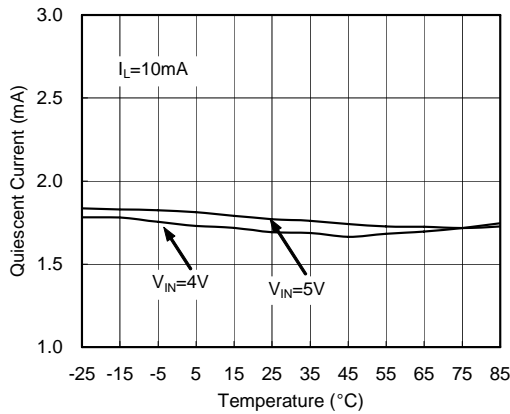

G9966-18 Dropout Voltage vs. I_L

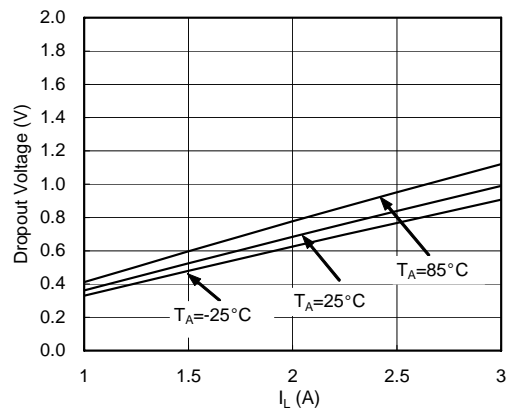

G9966-18 Output Voltage vs. Temperature

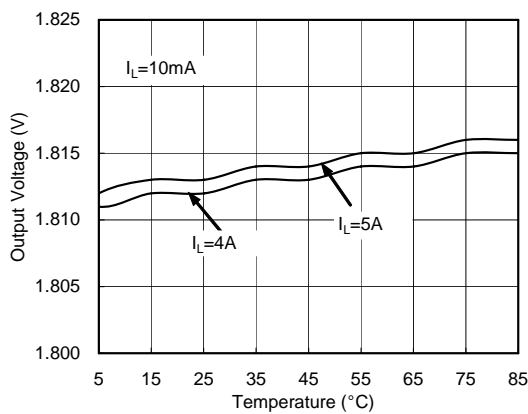

G9966-18 Output Voltage vs. I_L

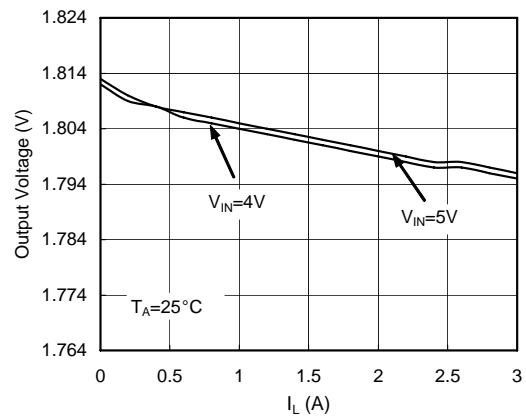

G9966-33 Quiescent Current vs. Temperature

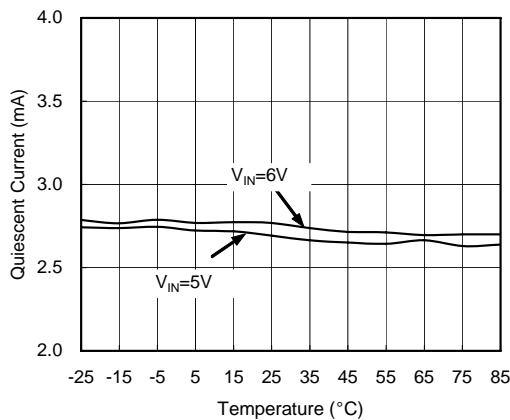

G9966-33 Dropout Voltage vs. I_L

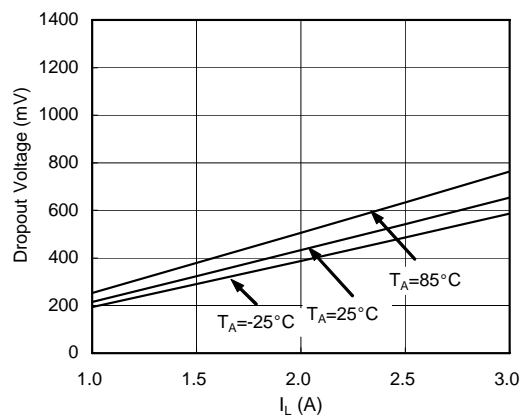

Typical Performance Characteristics (continued)

G9966-33 Output Voltage vs. Temperature

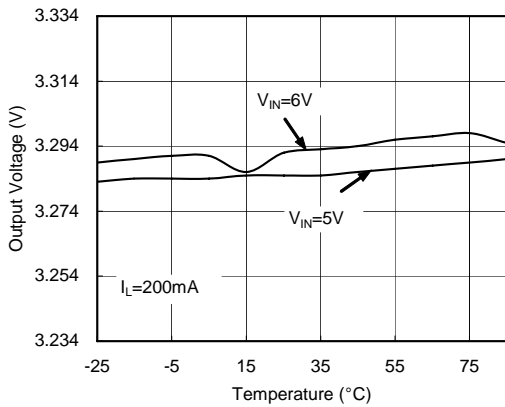

G9966-33 Output Voltage vs. I_L

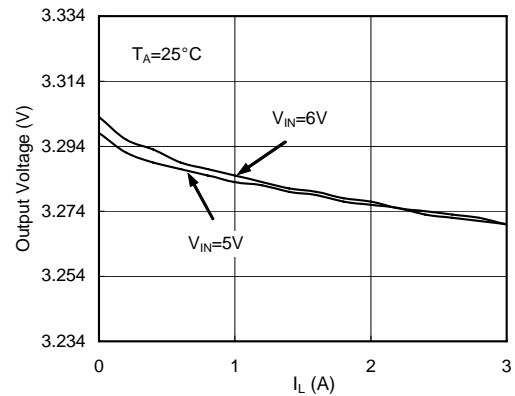

G9966-25 Quiescent Current vs. Temperature

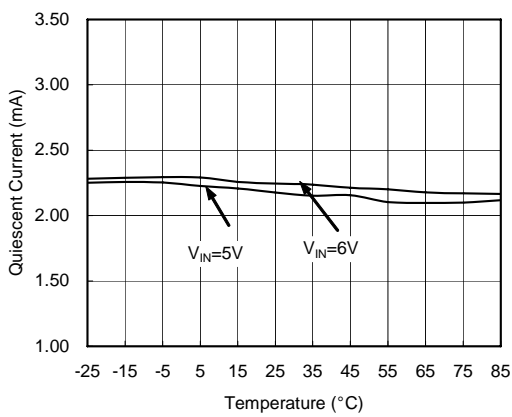

G9966-25 Dropout Voltage vs. I_L

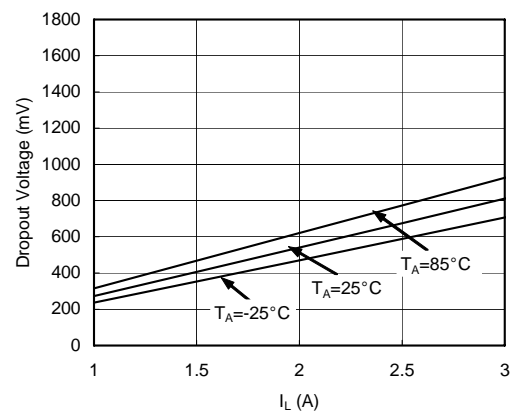

G9966-25 Output Voltage vs. Temperature

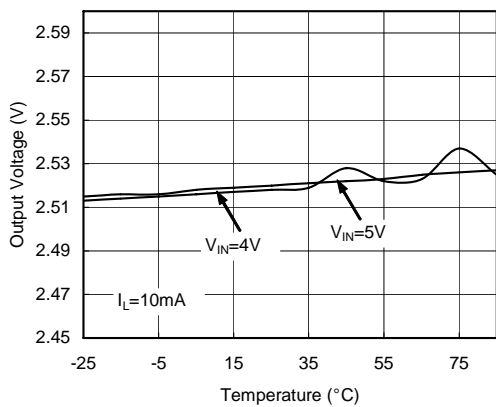

G9966-25 Output Voltage vs. I_L

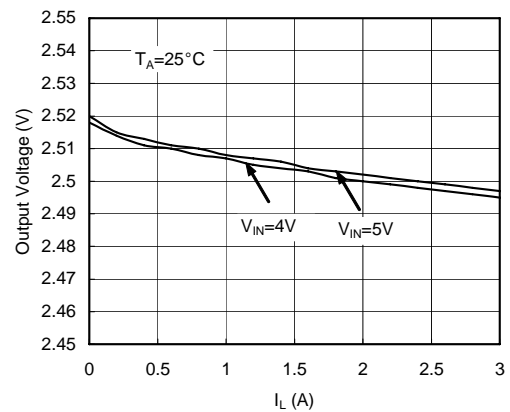

Recommended Minimum Footprint

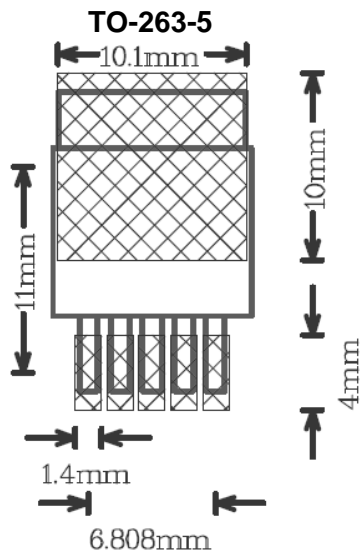

Package Information

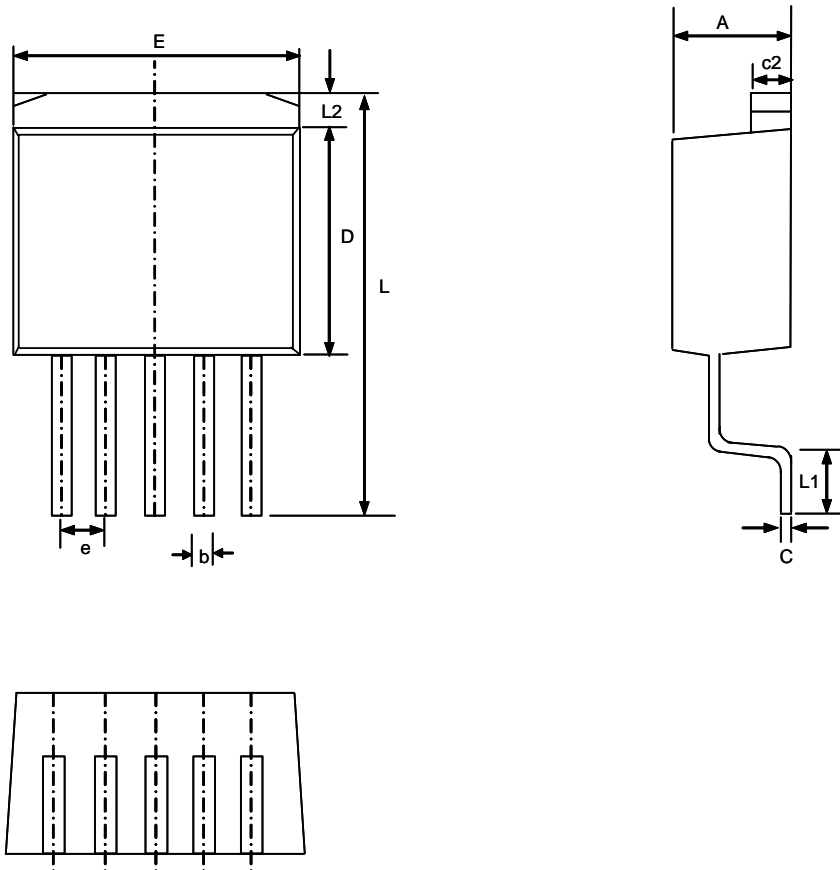

TO-263-5 Package

Note:

1. JEDEC Outline: N/A

SYMBOL	DIMENSION IN MM		DIMENSION IN INCH	
	MIN	MAX	MIN	MAX
A	4.064	4.826	0.160	0.190
b	0.686	0.940	0.027	0.037
c	0.381 TYP		0.015 TYP	
C2	1.143	1.397	0.045	0.055
D	8.636	9.652	0.340	0.380
E	9.652	10.287	0.380	0.405
e	1.702 BSC		0.067 BSC	
L	14.605	15.875	0.575	0.625
L1	2.286	2.794	0.090	0.110
L2	----	2.921	----	0.115

Taping Specification

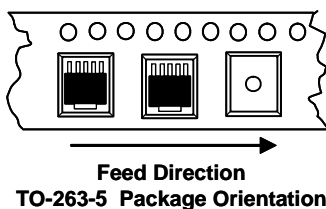

PACKAGE	Q'TY/BY REEL
TO-263-5	800 ea

GMT Inc. does not assume any responsibility for use of any circuitry described, no circuit patent licenses are implied and GMT Inc. reserves the right at any time without notice to change said circuitry and specifications.