



vorläufige Daten
 preliminary data

Höchstzulässige Werte / maximum rated values

Elektrische Eigenschaften / electrical properties

Kollektor Emitter Sperrspannung collector emitter voltage	$T_{vj} = 25^{\circ}\text{C}$	V_{CES}	1200	V
Kollektor Dauergleichstrom DC collector current	$T_c = 80^{\circ}\text{C}$ $T_c = 25^{\circ}\text{C}$	$I_{C, nom}$ I_C	600 850	A A
Periodischer Kollektor Spitzenstrom repetitive peak collector current	$t_p = 1\text{ms}, T_c = 80^{\circ}\text{C}$	I_{CRM}	1200	A
Gesamt Verlustleistung total power dissipation	$T_c = 25^{\circ}\text{C};$ Transistor	P_{tot}	2,8	kW
Gate Emitter Spitzenspannung gate emitter peak voltage		V_{GES}	+/- 20	V
Dauergleichstrom DC forward current		I_F	600	A
Periodischer Spitzenstrom repetitive peak forward current	$t_p = 1\text{ms}$	I_{FRM}	1200	A
Grenzlastintegral I^2t value	$V_R = 0\text{V}, t_p = 10\text{ms}, T_{vj} = 125^{\circ}\text{C}$	I^2t	75	k A ² s
Isolations Prüfspannung insulation test voltage	RMS, f= 50Hz, t= 1min.	V_{ISOL}	2,5	kV

Charakteristische Werte / characteristic values

Transistor Wechselrichter / transistor inverter

			min.	typ.	max.	
Kollektor Emitter Sättigungsspannung collector emitter saturation voltage	$I_C = 600\text{A}, V_{GE} = 15\text{V}, T_{vj} = 25^{\circ}\text{C},$ $I_C = 600\text{A}, V_{GE} = 15\text{V}, T_{vj} = 125^{\circ}\text{C},$	V_{CEsat}	-	1,7	2,15	V
Gate Schwellenspannung gate threshold voltage	$I_C = 24\text{mA}, V_{CE} = V_{GE}, T_{vj} = 25^{\circ}\text{C},$	$V_{GE(th)}$	5	5,8	6,5	V
Gateladung gate charge	$V_{GE} = -15\text{V} \dots +15\text{V}; V_{CE} = \dots\text{V}$	Q_G	-	5,8	-	μC
Eingangskapazität input capacitance	f= 1MHz, $T_{vj} = 25^{\circ}\text{C}, V_{CE} = 25\text{V}, V_{GE} = 0\text{V}$	C_{ies}	-	43	-	nF
Rückwirkungskapazität reverse transfer capacitance	f= 1MHz, $T_{vj} = 25^{\circ}\text{C}, V_{CE} = 25\text{V}, V_{GE} = 0\text{V}$	C_{res}	-	2	-	nF
Kollektor Emitter Reststrom collector emitter cut off current	$V_{GE} = 0\text{V}, T_{vj} = 25^{\circ}\text{C}, V_{CE} = 1200\text{V}$	I_{CES}	-	-	5	mA
Gate Emitter Reststrom gate emitter leakage current	$V_{CE} = 0\text{V}, V_{GE} = 20\text{V}, T_{vj} = 25^{\circ}\text{C}$	I_{GES}	-	-	400	nA

prepared by: MOD-D2; Mark Münzer

date of publication: 2002-07-30

approved: SM TM; Christoph Lübke

revision: 2.0



vorläufige Daten
preliminary data

Charakteristische Werte / characteristic values

Transistor Wechselrichter / transistor inverter

			min.	typ.	max.	
Einschaltverzögerungszeit (ind. Last) turn on delay time (inductive load)	$I_C = 600A, V_{CC} = 600V$ $V_{GE} = \pm 15V, R_{Gon} = 3,6\Omega, T_{vj} = 25^\circ C$	$t_{d,on}$	-	0,60	-	μs
	$V_{GE} = \pm 15V, R_{Gon} = 3,6\Omega, T_{vj} = 125^\circ C$		-	0,66	-	μs
Anstiegszeit (induktive Last) rise time (inductive load)	$I_C = 600A, V_{CC} = 600V$ $V_{GE} = \pm 15V, R_{Gon} = 3,6\Omega, T_{vj} = 25^\circ C$	t_r	-	0,23	-	μs
	$V_{GE} = \pm 15V, R_{Gon} = 3,6\Omega, T_{vj} = 125^\circ C$		-	0,22	-	μs
Abschaltverzögerungszeit (ind. Last) turn off delay time (inductive load)	$I_C = 600A, V_{CC} = 600V$ $V_{GE} = \pm 15V, R_{Goff} = 1,2\Omega, T_{vj} = 25^\circ C$	$t_{d,off}$	-	0,82	-	μs
	$V_{GE} = \pm 15V, R_{Goff} = 1,2\Omega, T_{vj} = 125^\circ C$		-	0,96	-	μs
Fallzeit (induktive Last) fall time (inductive load)	$I_C = 600A, V_{CC} = 600V$ $V_{GE} = \pm 15V, R_{Goff} = 1,2\Omega, T_{vj} = 25^\circ C$	t_f	-	0,15	-	μs
	$V_{GE} = \pm 15V, R_{Goff} = 1,2\Omega, T_{vj} = 125^\circ C$		-	0,18	-	μs
Einschaltverlustenergie pro Puls turn on energy loss per pulse	$I_C = 600A, V_{CC} = 600V, L_\sigma = 120nH$ $V_{GE} = \pm 15V, R_{Gon} = 3,6\Omega, T_{vj} = 125^\circ C$	E_{on}	-	120	-	mJ
Ausschaltverlustenergie pro Puls turn off energy loss per pulse	$I_C = 600A, V_{CC} = 600V, L_\sigma = 120nH$ $V_{GE} = \pm 15V, R_{Goff} = 1,2\Omega, T_{vj} = 125^\circ C$	E_{off}	-	95	-	mJ
Kurzschlussverhalten SC data	$t_p \leq 10\mu s, V_{GE} \leq 15V, T_{vj} \leq 125^\circ C$ $V_{CC} = 900V, V_{CEmax} = V_{CES} - L_{\sigma CE} \cdot di/dt $	I_{SC}	-	2400	-	A
Modulinduktivität stray inductance module		$L_{\sigma CE}$	-	20	-	nH
Leitungswiderstand, Anschluss-Chip lead resistance, terminal-chip	$T_c = 25^\circ C$	$R_{CC/EE}$	-	0,18	-	m Ω

Charakteristische Werte / characteristic values

Diode Wechselrichter / diode inverter

Durchlassspannung forward voltage	$I_F = I_{C, nom}, V_{GE} = 0V, T_{vj} = 25^\circ C$	V_F	-	2,0	2,5	V
	$I_F = I_{C, nom}, V_{GE} = 0V, T_{vj} = 125^\circ C$		-	1,8	-	V
Rückstromspitze peak reverse recovery current	$I_F = I_{C, nom}, -di_f/dt = 2400A/\mu s$ $V_R = 600V, V_{GE} = -15V, T_{vj} = 25^\circ C$	I_{RM}	-	170	-	A
	$V_R = 600V, V_{GE} = -15V, T_{vj} = 125^\circ C$		-	265	-	A
Sperrverzögerungsladung recovered charge	$I_F = I_{C, nom}, -di_f/dt = 2400A/\mu s$ $V_R = 600V, V_{GE} = -15V, T_{vj} = 25^\circ C$	Q_r	-	25	-	μC
	$V_R = 600V, V_{GE} = -15V, T_{vj} = 125^\circ C$		-	60	-	μC
Ausschaltenergie pro Puls reverse recovery energy	$I_F = I_{C, nom}, -di_f/dt = 2400A/\mu s$ $V_R = 600V, V_{GE} = -15V, T_{vj} = 25^\circ C$	E_{rec}	-	6	-	mJ
	$V_R = 600V, V_{GE} = -15V, T_{vj} = 125^\circ C$		-	17	-	mJ

Technische Information / technical information

eupec

IGBT-Module
IGBT-Modules

FF600R12KE3



vorläufige Daten
preliminary data

Thermische Eigenschaften / thermal properties

			min.	typ.	max.	
Innerer Wärmewiderstand thermal resistance, junction to case	Transistor, DC, pro Modul / per module	R_{thJC}	-	-	0,022	K/W
	Transistor, DC, pro Zweig / per arm		-	-	0,044	K/W
	Diode/Diode, DC, pro Modul / per module		-	-	0,040	K/W
	Diode/Diode, DC, pro Zweig / per arm		-	-	0,080	K/W
Übergangs Wärmewiderstand thermal resistance, case to heatsink	pro Modul / per module	R_{thCK}	-	0,006	-	K/W
	pro Zweig/ per arm $\lambda_{\text{Paste}}/\lambda_{\text{grease}} = 1\text{W/m}^2\text{K}$		-	0,012	-	K/W
Höchstzulässige Sperrschichttemp. maximum junction temperature		$T_{vj\max}$	-	-	150	°C
Betriebstemperatur operation temperature		$T_{vj\text{op}}$	-40	-	125	°C
Lagertemperatur storage temperature		T_{stg}	-40	-	125	°C

Mechanische Eigenschaften / mechanical properties

Gehäuse, siehe Anlage case, see appendix						
Innere Isolation internal insulation				Al_2O_3		
Kriechstrecke creepage distance				17		mm
Luftstrecke clearance				10		mm
CTI comperative tracking index				>400		
Anzugsdrehmoment, mech. Befestigung mounting torque	Schraube / screw M5	M	4,25	-	5,75	Nm
Anzugsdrehmoment, elektr. Anschlüsse terminal connection torque	Anschlüsse / terminal M4	M	1,7	-	2,3	Nm
	Anschlüsse / terminal M8	M	8	-	10	Nm
Gewicht weight		G		1500		g

Mit dieser technischen Information werden Halbleiterbauelemente spezifiziert, jedoch keine Eigenschaften zugesichert. Sie gilt in Verbindung mit den zugehörigen technischen Erläuterungen.

This technical information specifies semiconductor devices but promises no characteristics. It is valid with the belonging technical notes.



vorläufige Daten
preliminary data

Ausgangskennlinie (typisch)
output characteristic (typical)

$I_C = f(V_{CE})$
 $V_{GE} = 15V$

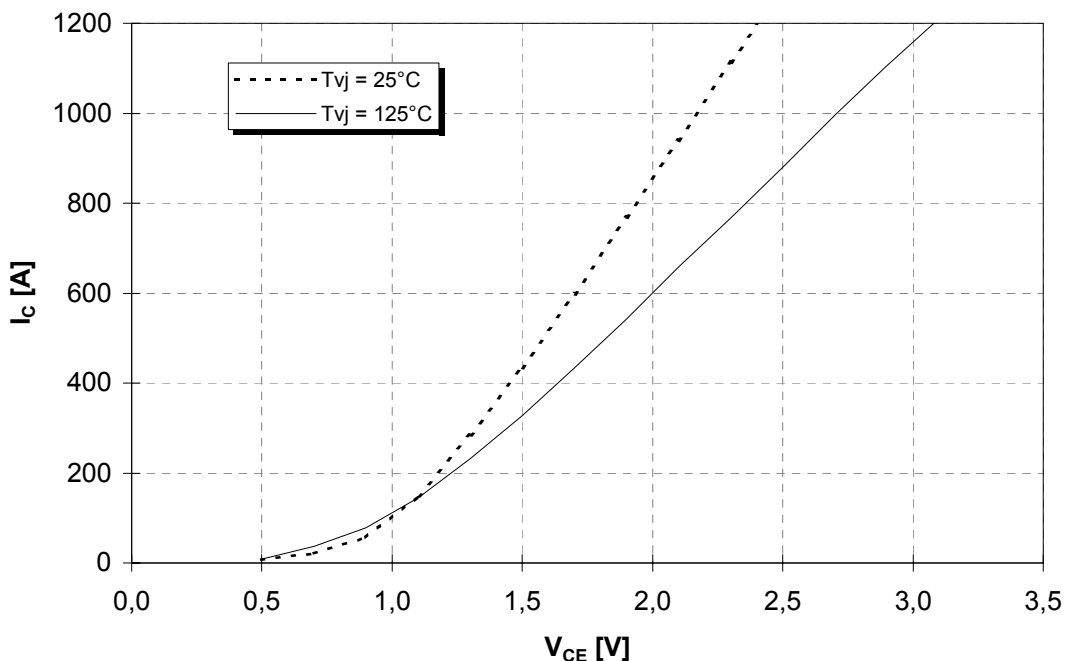

Ausgangskennlinienfeld (typisch)
output characteristic (typical)

$I_C = f(V_{CE})$
 $T_{vj} = 125°C$

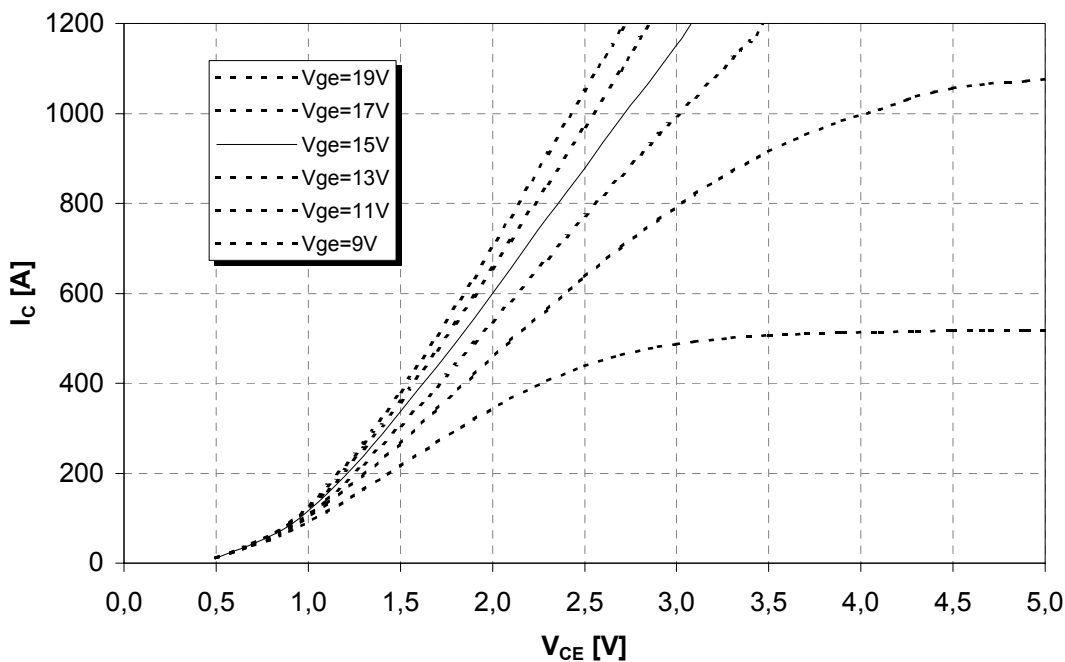



vorläufige Daten
preliminary data

Übertragungscharakteristik (typisch)
transfer characteristic (typical)

$I_C = f(V_{GE})$
 $V_{CE} = 20V$

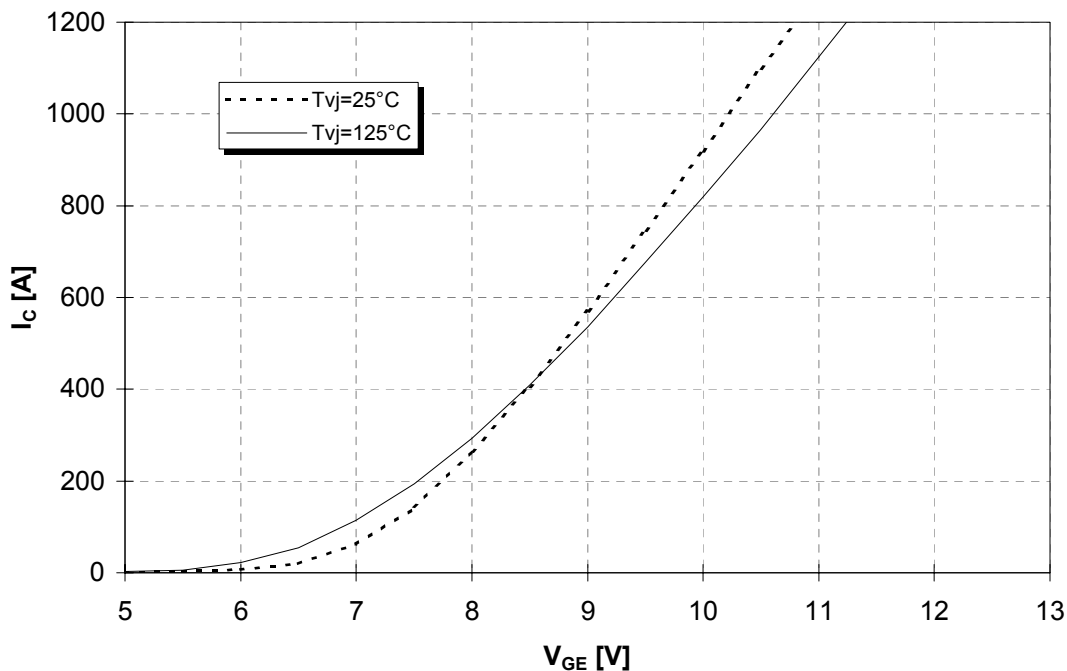

Durchlasskennlinie der Inversdiode (typisch)
forward characteristic of inverse diode (typical)

$I_F = f(V_F)$

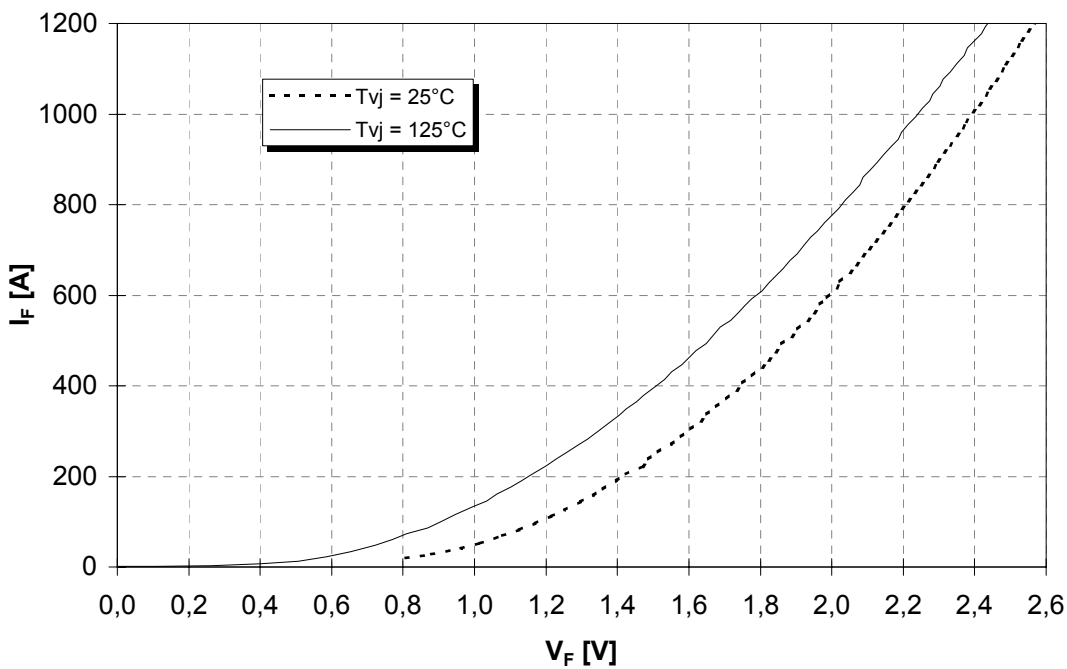



vorläufige Daten
preliminary data

Schaltverluste (typisch)
Switching losses (typical)

$$E_{on} = f(I_C), E_{off} = f(I_C), E_{rec} = f(I_C)$$

$V_{GE} = \pm 15V, R_{\theta on} = 3,6\Omega, R_{\theta off} = 1,2\Omega, V_{CE} = 600V, T_{vi} = 125^\circ C$

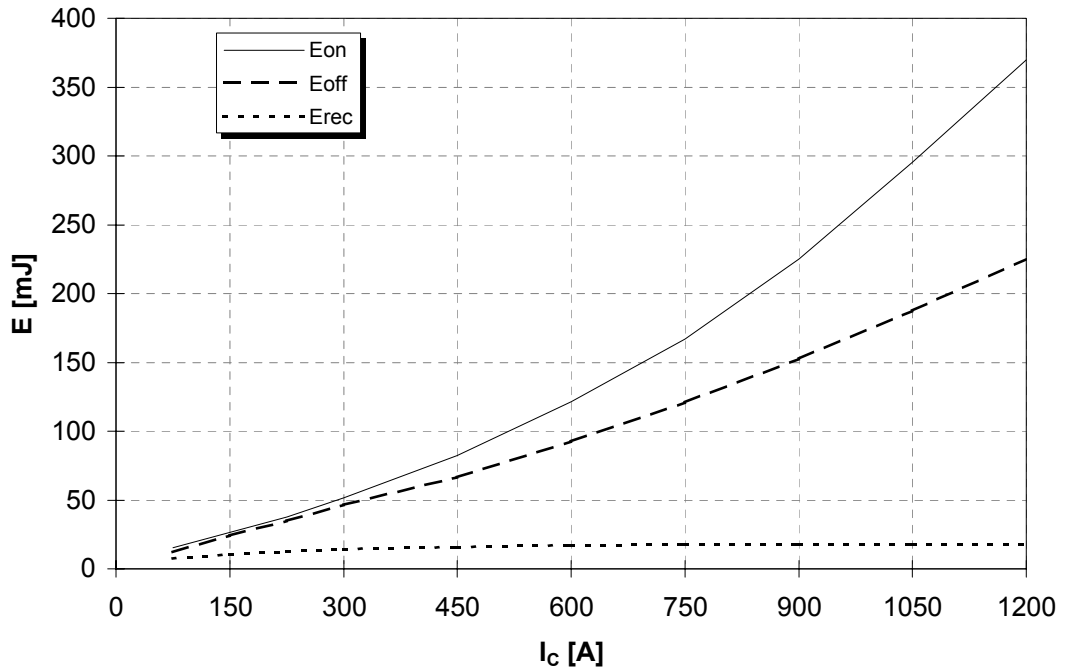

Schaltverluste (typisch)
Switching losses (typical)

$$E_{on} = f(R_G), E_{off} = f(R_G), E_{rec} = f(R_G)$$

$V_{GE} = \pm 15V, I_C = 600A, V_{CE} = 600V, T_{vi} = 125^\circ C$

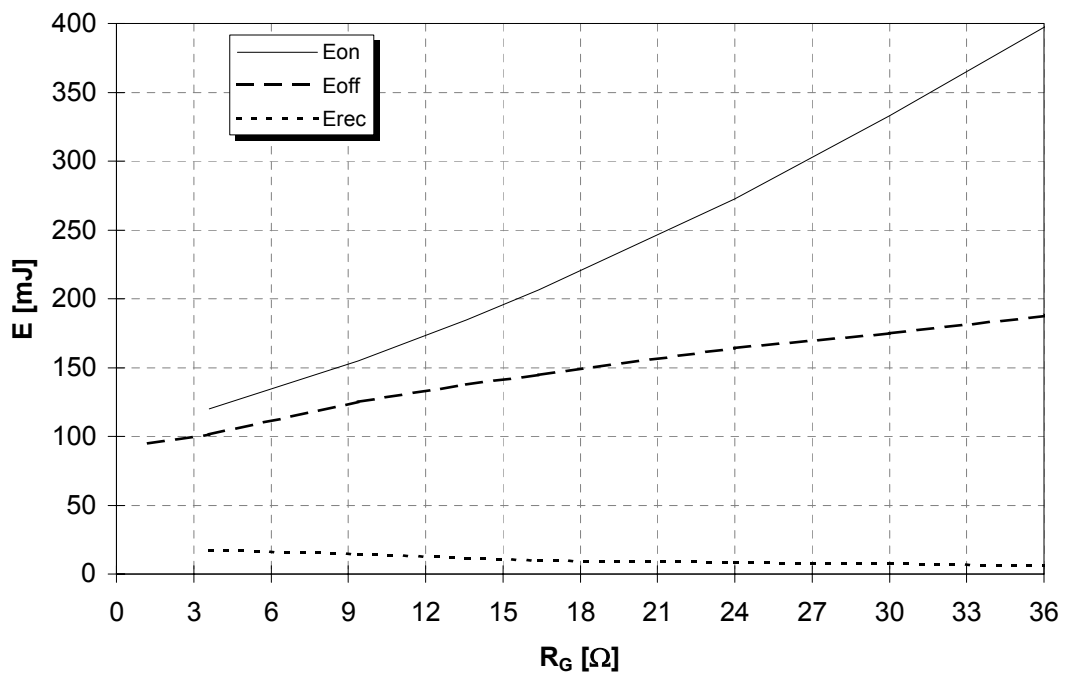



vorläufige Daten
preliminary data

Transienter Wärmewiderstand
Transient thermal impedance

$$Z_{thJC} = f(t)$$

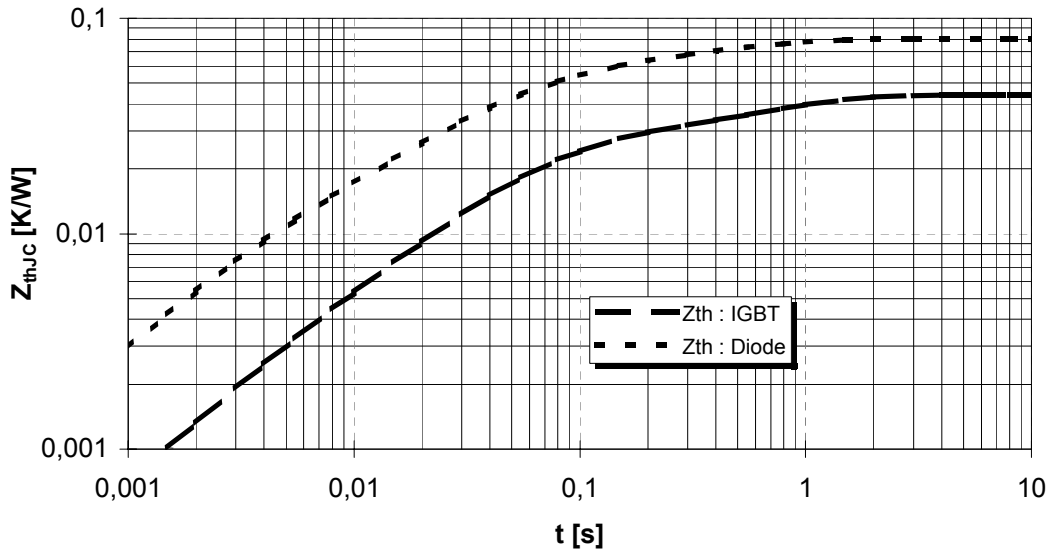

i	1	2	3	4
r_i [K/kW] : IGBT	18,49	22,17	2,51	0,83
τ_i [s] : IGBT	6,897E-01	5,634E-02	2,997E-02	3,820E-03
r_i [K/kW] : Diode	22,96	25,20	26,46	5,38
τ_i [s] : Diode	4,452E-01	7,451E-02	2,647E-02	2,850E-03

Sicherer Arbeitsbereich (RBSOA)

Reverse bias safe operation area (RBSOA)

$$V_{GE} = \pm 15V, T_{vj} = 125^\circ C$$

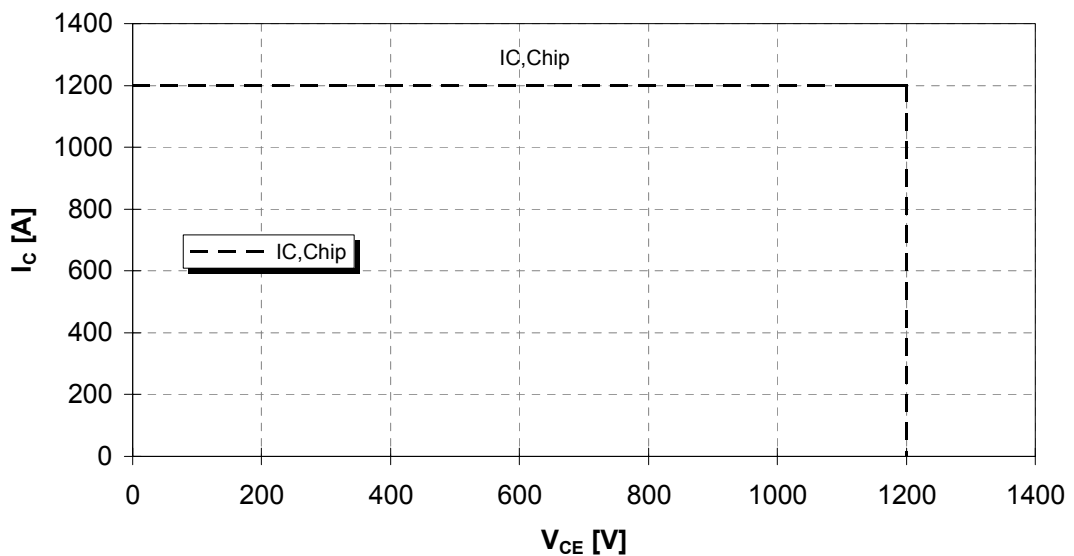

IGBT-Module
IGBT-Modules

FF600R12KE3



vorläufige Daten
preliminary data

Gehäusemaße / Schaltbild Package outline / Circuit diagram

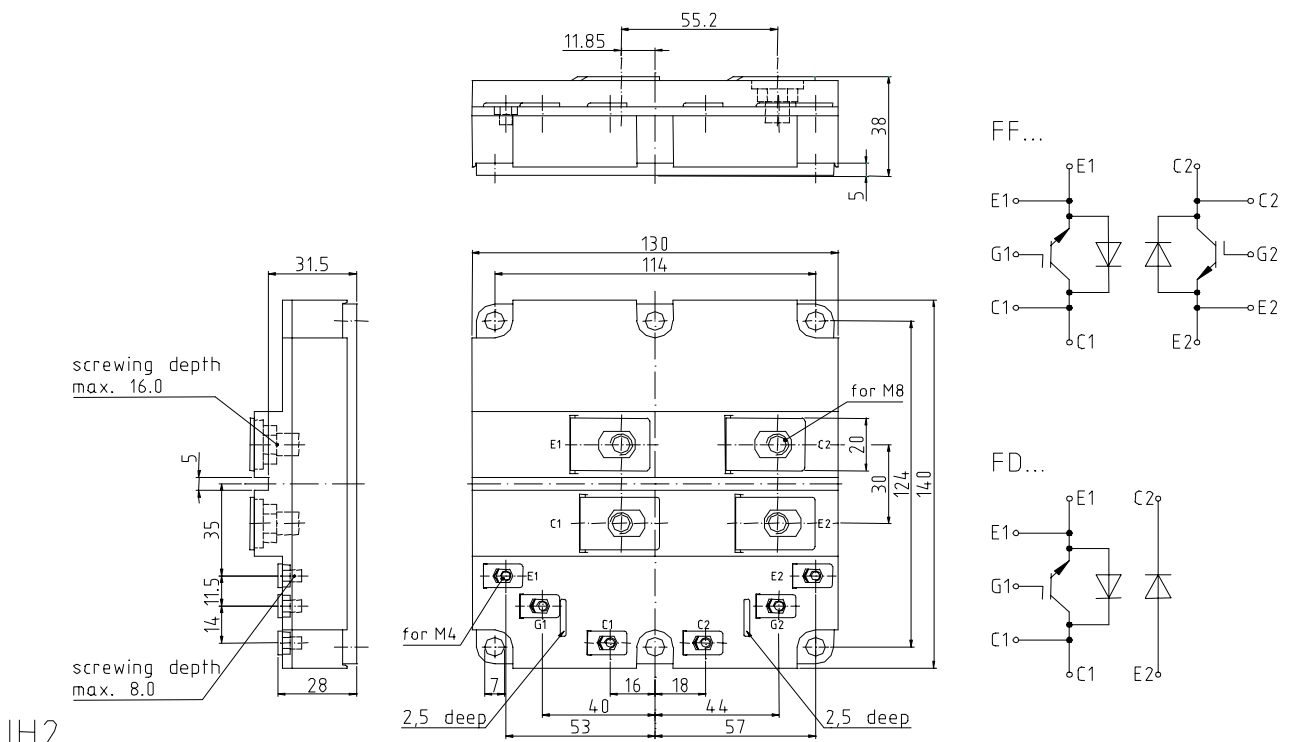

IH2

Terms & Conditions of Usage

Attention

The present product data is exclusively subscribed to technically experienced staff. This Data Sheet is describing the specification of the products for which a warranty is granted exclusively pursuant the terms and conditions of the supply agreement. There will be no guarantee of any kind for the product and its specifications. Changes to the Data Sheet are reserved.

You and your technical departments will have to evaluate the suitability of the product for the intended application and the completeness of the product data with respect to such application. Should you require product information in excess of the data given in the Data Sheet, please contact your local Sales Office via "www.eupec.com / sales & contact".

Warning

Due to technical requirements the products may contain dangerous substances. For information on the types in question please contact your local Sales Office via "www.eupec.com / sales & contact".