

L-796BID HIGH EFFICIENCY RED

L-796BGD GREEN

L-796BYD YELLOW

L-796BSRC-B SUPER BRIGHT RED

L-796BSRD-B SUPER BRIGHT RED

Features

- 8mm DIAMETER BIG LAMP WITH BULIT-IN BLINKING IC.
- OPERATION VOLTAGE FROM 3.5V to 14V.
- BLINKING FREQUENCY FROM 3.0Hz to 1.5Hz.

Description

The High Efficiency Red source color devices are made with Gallium Arsenide Phosphide on Gallium Phosphide Orange Light Emitting Diode.

The Green source color devices are made with Gallium Phosphide Green Light Emitting Diode.

The Yellow source color devices are made with Gallium Arsenide Phosphide on Gallium Phosphide Yellow Light Emitting Diode.

The Super Bright Red source color devices are made with Gallium Aluminum Arsenide Red Light Emitting Diode.

Package Dimensions

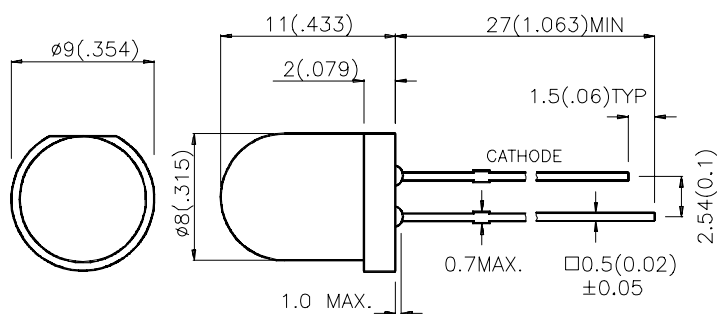

Notes:

1. All dimensions are in millimeters (inches).
2. Tolerance is $\pm 0.25(0.01)$ unless otherwise noted.
3. Lead spacing is measured where the lead emerge package.
4. Specifications are subject to change without notice.

Selection Guide

Part No.	Dice	Lens Type	Iv (mcd) VF=9V		Viewing Angle
			Min.	Typ.	2θ1/2
L-796BID	HIGH EFFICIENCY RED (GaAsP/GaP)	RED DIFFUSED	20	60	60°
L-796BGD	GREEN (GaP)	GREEN DIFFUSED	20	50	60°
L-796BYD	YELLOW (GaAsP/GaP)	YELLOW DIFFUSED	20	40	60°
L-796BSRD-B	SUPER BRIGHT RED(GaAlAs)	RED DIFFUSED	100	300	60°
L-796BSRC-B	SUPER BRIGHT RED(GaAlAs)	WATER CLEAR	500	800	40°

Note:

1. θ1/2 is the angle from optical centerline where the luminous intensity is 1/2 the optical centerline value..

Electrical / Optical Characteristics at T_A=25°C

Symbol	Parameter	Device	Min	Typ	Units	Test Conditions
λ _{peak}	Peak Wavelength	High Efficiency Red Green Yellow Super Bright Red		627 565 590 660	nm	
λ _D	Dominate Wavelength	High Efficiency Red Green Yellow Super Bright Red		625 568 588 640	nm	
Δλ _{1/2}	Spectral Line Halfwidth	High Efficiency Red Green Yellow Super Bright Red		45 30 35 20	nm	
I _F	Forward Current	High Efficiency Red Green Yellow Super Bright Red	8 8 8 8	22 20 21 25	mA	Min: V _F =3.5V Typ: V _F =5V
I _{SON}	Supply Current	High Efficiency Red Green Yellow Super Bright Red		8~44 8~42 8~43 8~45	uA	V _F =3.5V~14V
f	Blink Frequency	All		3~1.5	Hz	V _F =3.5V~14V

Absolute Maximum Ratings at $T_A=25^\circ\text{C}$

Parameter	High Efficiency Red	Green	Yellow	Super Bright Red	Units
Power dissipation	310	310	310	310	mW
DC Forward Current	55	55	55	55	mA
Reverse Voltage	0.5	0.5	0.5	0.5	V
Operating Temperature	-40°C To +70°C				
Storage Temperature	-50°C To +100°C				
Lead Soldering Temperature [1]	260°C For 5 Seconds				

Note:

1. 4mm below package base.

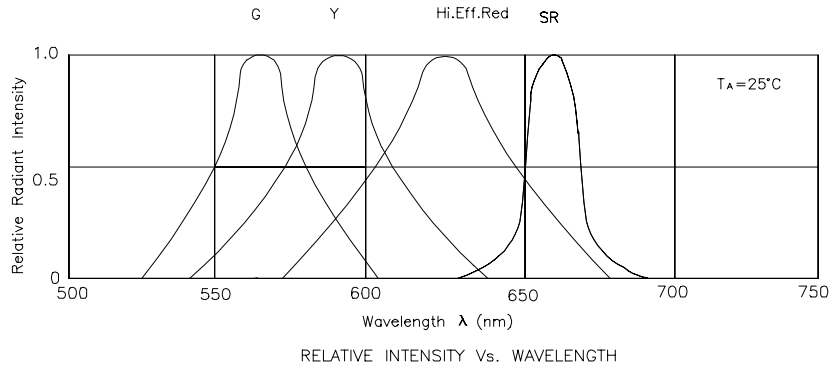

High Efficiency Red L-796BID

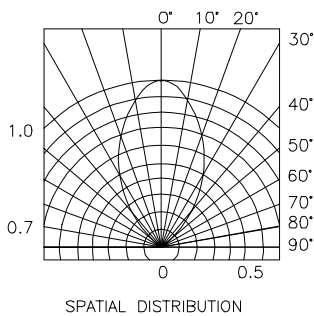
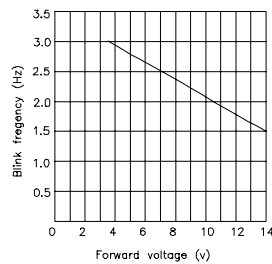
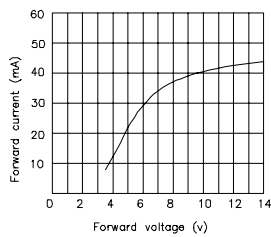

Green L-796BGD

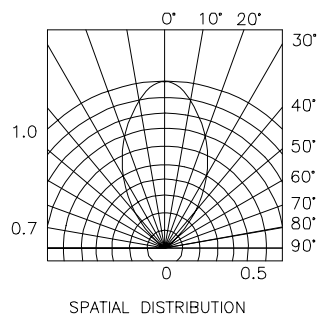
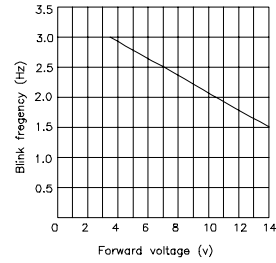
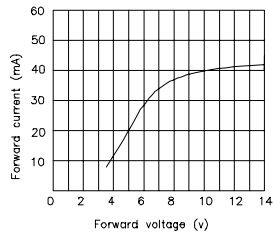

Yellow L-796BYD

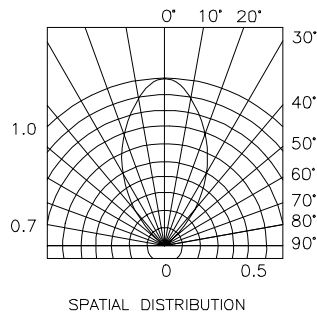
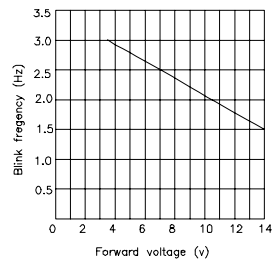
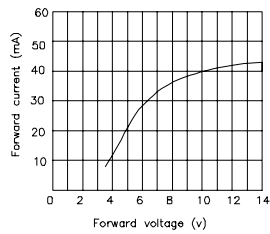

Super Bright Red L-796BSRD-B

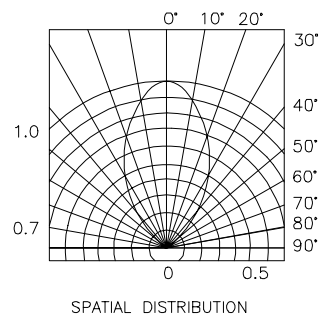
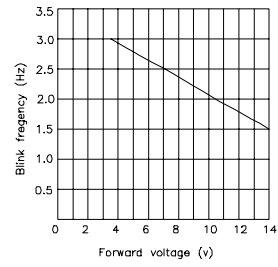
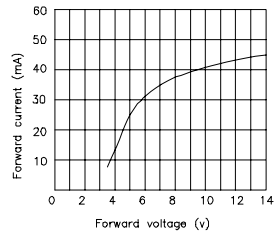

Super Bright Red L-796BSRC-B

