

---

# 2SK2685

GaAs HEMT

# HITACHI

ADE-208-400  
1st. Edition

---

## Application

UHF low noise amplifier

## Features

- Excellent low noise characteristics.  
Fmin = 0.83 dB Typ. (3 V, 10 mA, 2 GHz)
- High associated gain.  
Ga = 17 dB Typ. (3 V, 10 mA, 2 GHz)
- High voltage.  
 $V_{DS}$  = 6 or more voltage.
- Small package. (CMPAK-4)

## Outline

CMPAK-4

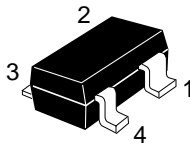

1. Source
2. Gate
3. Source
4. Drain

## Absolute Maximum Ratings (Ta = 25°C)

Item	Symbol	Ratings	Unit
Drain to source voltage	$V_{DSS}$	6	V
Gate to source voltage	$V_{GSO}$	-6	V
Gate to drain voltage	$V_{GDO}$	-7	V
Drain current	$I_D$	20	mA
Channel power dissipation	Pch	100	mW
Channel temperature	Tch	125	°C
Storage temperature	Tstg	-55 to +125	°C

Attention: This device is very sensitive to electro static discharge.

It is recommended to adopt appropriate cautions when handling this transistor.

## Electrical Characteristics (Ta = 25°C)

Item	Symbol	Min	Typ	Max	Unit	Test conditions
Gate to source leak current	$I_{GSS}$	—	—	-20	$\mu$ A	$V_{GS} = -6$ V, $V_{DS} = 0$
Gate to source cutoff voltage	$V_{GS(off)}$	-0.3	—	-2.0	V	$V_{DS} = 3$ V, $I_D = 100$ $\mu$ A
Drain current	$I_{DSS}$	35	50	70	mA	$V_{DS} = 3$ V, $V_{GS} = 0$ (Pulse Test)
Forward transfer admittance	$ y_{fs} $	40	60	—	mS	$V_{DS} = 3$ V, $I_D = 10$ mA, $f = 1$ kHz
Associated gain	Ga	—	17.0	—	dB	$V_{DS} = 3$ V, $I_D = 10$ mA, $f = 2$ GHz
Associated gain	Ga	—	15.2	—	dB	$V_{DS} = 3$ V, $I_D = 3$ mA, $f = 2$ GHz
Associated gain	Ga	16	21.4	—	dB	$V_{DS} = 3$ V, $I_D = 10$ mA, $f = 900$ MHz
Associated gain	Ga	—	19.7	—	dB	$V_{DS} = 3$ V, $I_D = 3$ mA, $f = 900$ MHz
Minimum noise figure	Fmin	—	0.83	—	dB	$V_{DS} = 3$ V, $I_D = 10$ mA, $f = 2$ GHz
Minimum noise figure	Fmin	—	1.08	—	dB	$V_{DS} = 3$ V, $I_D = 3$ mA, $f = 2$ GHz
Minimum noise figure	Fmin	—	0.52	1.0	dB	$V_{DS} = 3$ V, $I_D = 10$ mA, $f = 900$ MHz
Minimum noise figure	Fmin	—	0.74	—	dB	$V_{DS} = 3$ V, $I_D = 3$ mA, $f = 900$ MHz

Note: Marking is "ZT-".

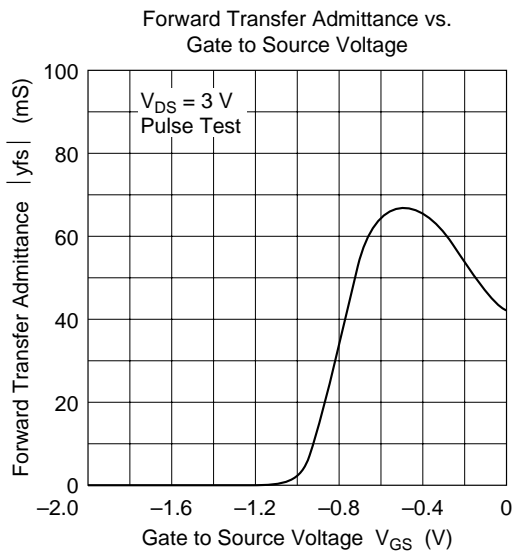
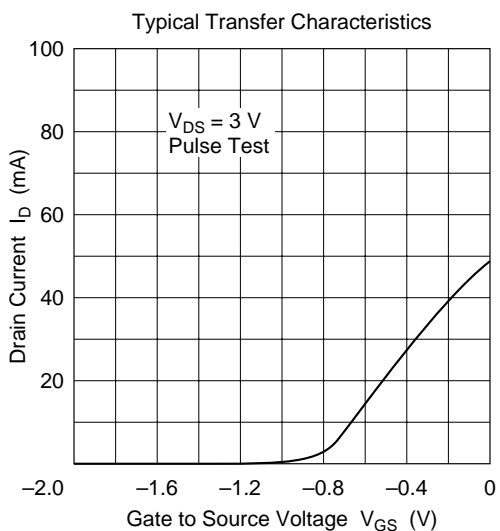
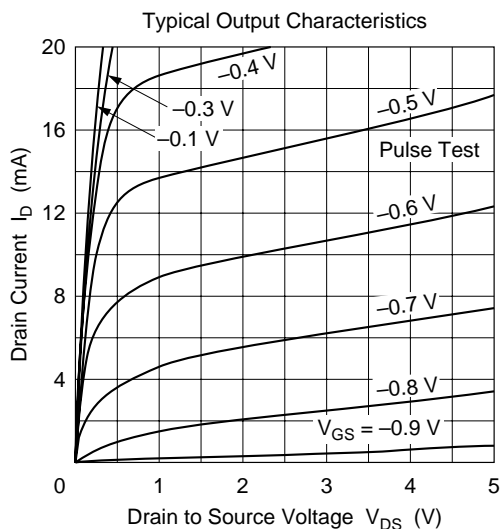
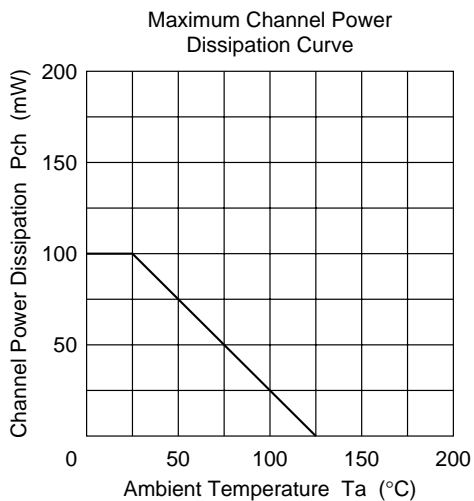

Forward Transfer Admittance vs. Drain Current

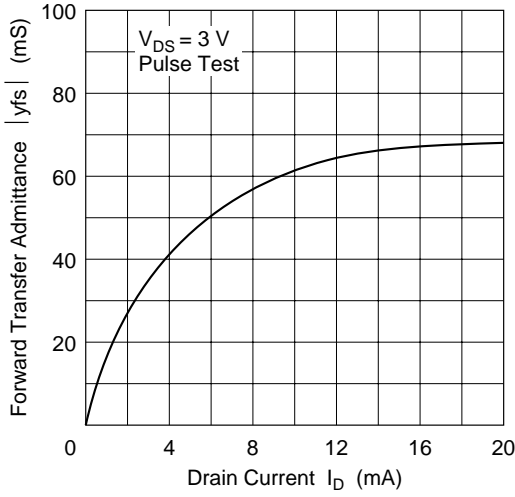

Associated Gain vs. Drain Current

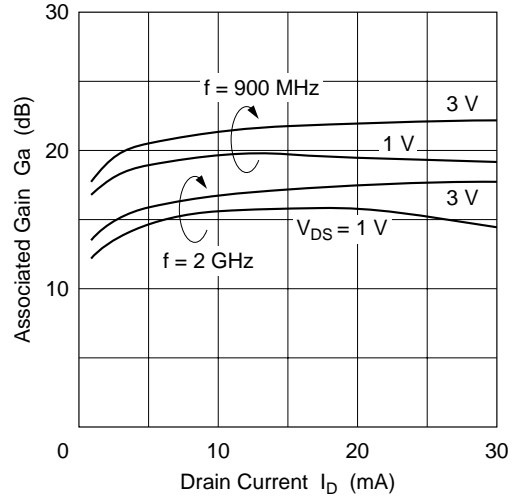

Minimum Noise Figure vs. Drain Current

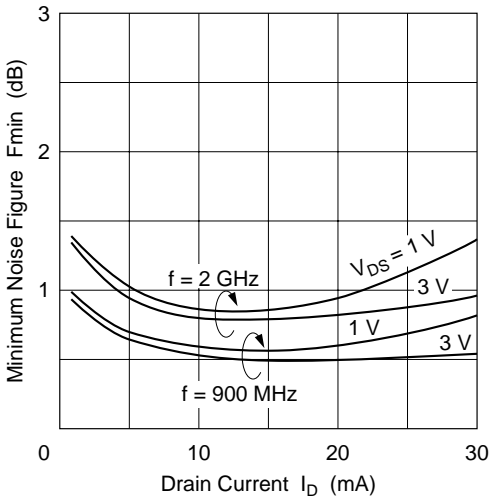

Associated Gain vs. Drain to Source Voltage

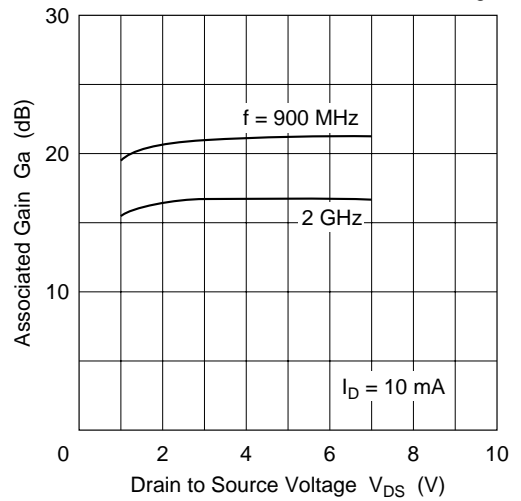

Minimum Noise Figure vs.  
Drain to Source Voltage

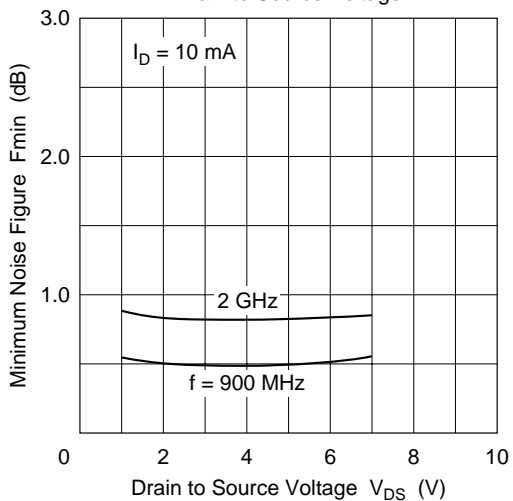

Isolation vs. Drain Current

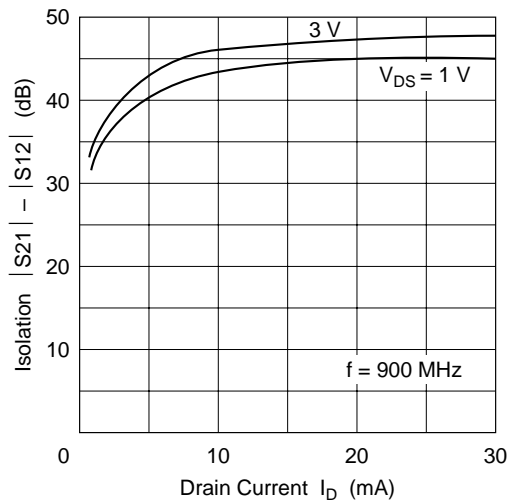

Isolation vs. Drain Current

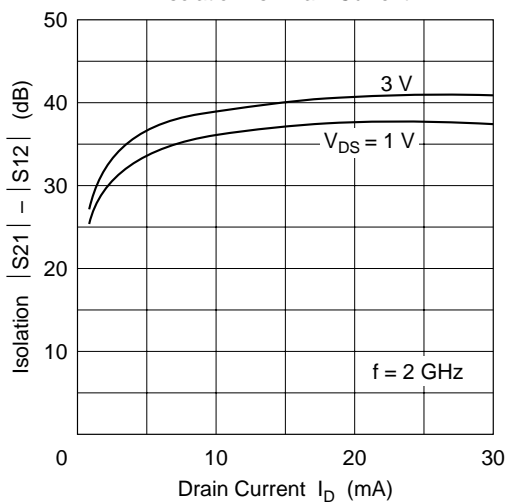

S11 Parameter vs. Frequency

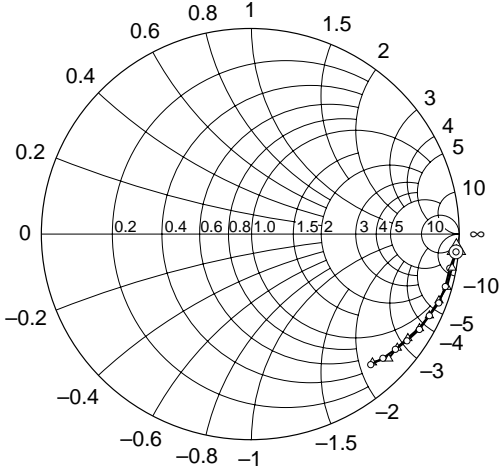

Condition :  $I_D = 10 \text{ mA}$ ,  $Z_o = 50 \Omega$   
200 to 2000 MHz (200 MHz step)

○ — ○ ( $V_{DS} = 1 \text{ V}$ )  
△ — △ ( $V_{DS} = 3 \text{ V}$ )

S12 Parameter vs. Frequency

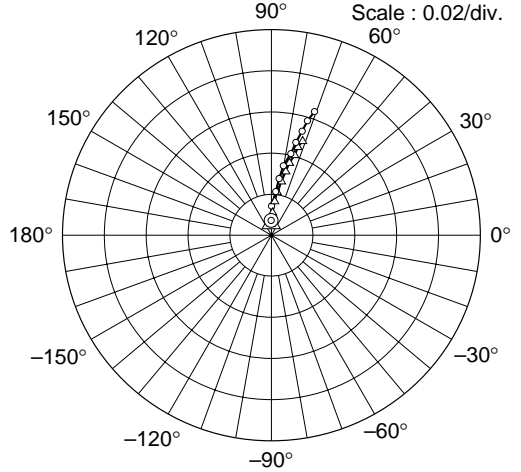

Condition :  $I_D = 10 \text{ mA}$ ,  $Z_o = 50 \Omega$   
200 to 2000 MHz (200 MHz step)

○ — ○ ( $V_{DS} = 1 \text{ V}$ )  
△ — △ ( $V_{DS} = 3 \text{ V}$ )

S21 Parameter vs. Frequency

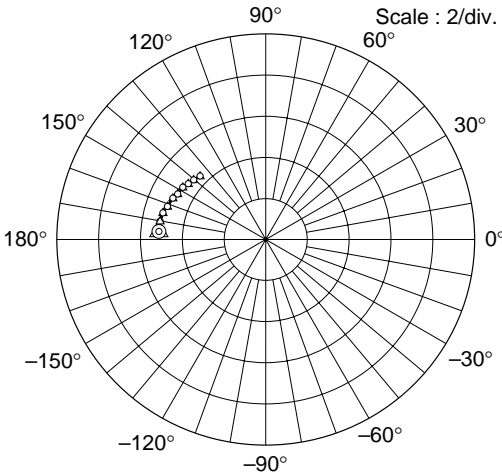

Condition :  $I_D = 10 \text{ mA}$ ,  $Z_o = 50 \Omega$   
200 to 2000 MHz (200 MHz step)

○ — ○ ( $V_{DS} = 1 \text{ V}$ )  
△ — △ ( $V_{DS} = 3 \text{ V}$ )

S22 Parameter vs. Frequency

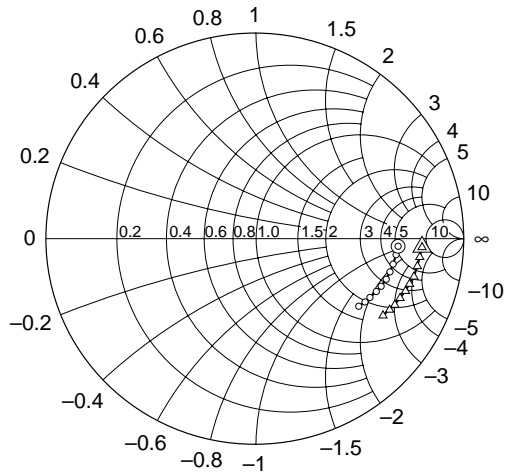

Condition :  $I_D = 10 \text{ mA}$ ,  $Z_o = 50 \Omega$   
200 to 2000 MHz (200 MHz step)

○ — ○ ( $V_{DS} = 1 \text{ V}$ )  
△ — △ ( $V_{DS} = 3 \text{ V}$ )

**S Parameter** ( $V_{DS} = 1\text{ V}$ ,  $I_D = 10\text{ mA}$ ,  $Z_O = 50\ \Omega$ )

Freq. (MHz)	S11		S21		S12		S22	
	MAG.	ANG.	MAG.	ANG.	MAG.	ANG.	MAG.	ANG.
200	0.996	-4.8	5.12	175.8	0.00691	89.8	0.688	-3.2
400	0.980	-9.5	5.13	169.9	0.0143	88.2	0.682	-6.5
600	0.977	-15.0	5.07	165.4	0.0210	83.3	0.674	-10.6
800	0.970	-19.9	4.94	161.6	0.0276	81.5	0.668	-13.8
1000	0.952	-24.4	4.84	156.5	0.0399	79.3	0.658	-17.2
1200	0.938	-29.2	4.74	152.7	0.0404	76.0	0.648	-20.7
1400	0.916	-34.0	4.67	147.7	0.0462	74.8	0.636	-23.7
1600	0.896	-38.2	4.55	144.1	0.0523	73.1	0.622	-27.1
1800	0.882	-42.9	4.47	140.0	0.0578	72.0	0.611	-29.9
2000	0.859	-47.1	4.36	135.8	0.0630	70.3	0.597	-33.1

**S Parameter** ( $V_{DS} = 3\text{ V}$ ,  $I_D = 10\text{ mA}$ ,  $Z_O = 50\ \Omega$ )

Freq. (MHz)	S11		S21		S12		S22	
	MAG.	ANG.	MAG.	ANG.	MAG.	ANG.	MAG.	ANG.
200	0.998	-4.0	5.13	175.8	0.00581	89.8	0.802	-3.2
400	0.988	-9.2	5.14	170.1	0.0110	85.5	0.796	-6.5
600	0.978	-14.5	5.08	165.2	0.0163	83.3	0.790	-9.8
800	0.968	-19.4	4.95	161.4	0.0216	82.0	0.783	-13.3
1000	0.953	-24.2	4.85	156.4	0.0363	79.2	0.774	-16.4
1200	0.937	-28.7	4.75	152.5	0.0312	76.5	0.764	-19.4
1400	0.917	-33.3	4.68	147.8	0.0358	75.3	0.753	-22.5
1600	0.900	-37.5	4.57	144.0	0.0401	73.2	0.742	-25.4
1800	0.883	-41.9	4.49	140.1	0.0442	72.8	0.731	-28.1
2000	0.858	-46.1	4.37	135.9	0.0477	71.4	0.718	-31.1





---

## Datasheet Title

---

### Cautions

1. Hitachi neither warrants nor grants licenses of any rights of Hitachi's or any third party's patent, copyright, trademark, or other intellectual property rights for information contained in this document. Hitachi bears no responsibility for problems that may arise with third party's rights, including intellectual property rights, in connection with use of the information contained in this document.
2. Products and product specifications may be subject to change without notice. Confirm that you have received the latest product standards or specifications before final design, purchase or use.
3. Hitachi makes every attempt to ensure that its products are of high quality and reliability. However, contact Hitachi's sales office before using the product in an application that demands especially high quality and reliability or where its failure or malfunction may directly threaten human life or cause risk of bodily injury, such as aerospace, aeronautics, nuclear power, combustion control, transportation, traffic, safety equipment or medical equipment for life support.
4. Design your application so that the product is used within the ranges guaranteed by Hitachi particularly for maximum rating, operating supply voltage range, heat radiation characteristics, installation conditions and other characteristics. Hitachi bears no responsibility for failure or damage when used beyond the guaranteed ranges. Even within the guaranteed ranges, consider normally foreseeable failure rates or failure modes in semiconductor devices and employ systemic measures such as fail-safes, so that the equipment incorporating Hitachi product does not cause bodily injury, fire or other consequential damage due to operation of the Hitachi product.
5. This product is not designed to be radiation resistant.
6. No one is permitted to reproduce or duplicate, in any form, the whole or part of this document without written approval from Hitachi.
7. Contact Hitachi's sales office for any questions regarding this document or Hitachi semiconductor products.

1. This product must not be placed in the mouth, as it contains toxic substances that may cause poisoning. If by chance the product is placed in the mouth, take emergency action such as inducing vomiting, then consult a physician without delay.
2. Disposal of this product must be handled, separately from other general refuse, by a specialist processing contractor in the same way as dangerous items.

---

---

# HITACHI

## Hitachi, Ltd.

Semiconductor & Integrated Circuits.

Nippon Bldg., 2-6-2, Ohte-machi, Chiyoda-ku, Tokyo 100-0004, Japan

Tel: Tokyo (03) 3270-2111 Fax: (03) 3270-5109

URL    NorthAmerica    : <http://semiconductor.hitachi.com/>  
      Europe            : <http://www.hitachi-eu.com/hel/ecg>  
      Asia (Singapore) : <http://www.has.hitachi.com.sg/grp3/sicd/index.htm>  
      Asia (Taiwan)    : [http://www.hitachi.com.tw/E/Product/SICD\\_Frame.htm](http://www.hitachi.com.tw/E/Product/SICD_Frame.htm)  
      Asia (HongKong) : <http://www.hitachi.com.hk/eng/bo/grp3/index.htm>  
      Japan             : <http://www.hitachi.co.jp/Sicd/indx.htm>

### For further information write to:

Hitachi Semiconductor  
(America) Inc.  
179 East Tasman Drive,  
San Jose, CA 95134  
Tel: <1> (408) 433-1990  
Fax: <1> (408) 433-0223

Hitachi Europe GmbH  
Electronic components Group  
Domacher Straße 3  
D-85622 Feldkirchen, Munich  
Germany  
Tel: <49> (89) 9 9180-0  
Fax: <49> (89) 9 29 30 00

Hitachi Europe Ltd.  
Electronic Components Group.  
Whitebrook Park  
Lower Cookham Road  
Maidenhead  
Berkshire SL6 8YA, United Kingdom  
Tel: <44> (1628) 585000  
Fax: <44> (1628) 778322

Hitachi Asia Pte. Ltd.  
16 Collyer Quay #20-00  
Hitachi Tower  
Singapore 049318  
Tel: 535-2100  
Fax: 535-1533

Hitachi Asia Ltd.  
Taipei Branch Office  
3F, Hung Kuo Building, No.167,  
Tun-Hwa North Road, Taipei (105)  
Tel: <886> (2) 2718-3666  
Fax: <886> (2) 2718-8180

Hitachi Asia (Hong Kong) Ltd.  
Group III (Electronic Components)  
7/F., North Tower, World Finance Centre,  
Harbour City, Canton Road, Tsim Sha Tsui,  
Kowloon, Hong Kong  
Tel: <852> (2) 735 9218  
Fax: <852> (2) 730 0281  
Telex: 40815 HITEC HX

Copyright © Hitachi, Ltd., 1998. All rights reserved. Printed in Japan.