

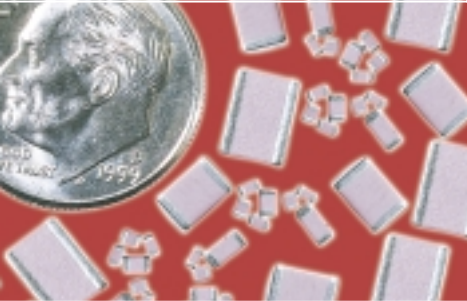

NOVACAP A **DOVER** COMPANY

CERAMIC MULTILAYER CAPACITORS

PRODUCT CATALOG



QUALITY

DELIVERY

PERFORMANCE

SERVICE

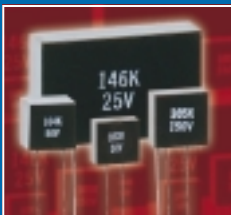

www.DataSheet4U.com



QUALITY

DELIVERY

QUALITY

DELIVERY

PERFORMANCE

SERVICE

PERFORMANCE

SERVICE

OVACAP

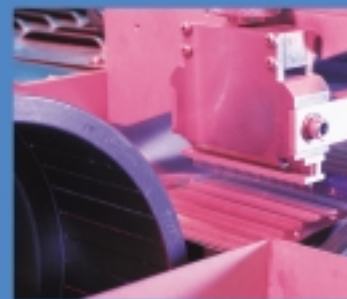
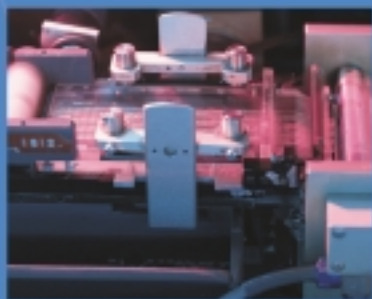

QUALITY

DELIVERY

PERFORMANCE

SERVICE

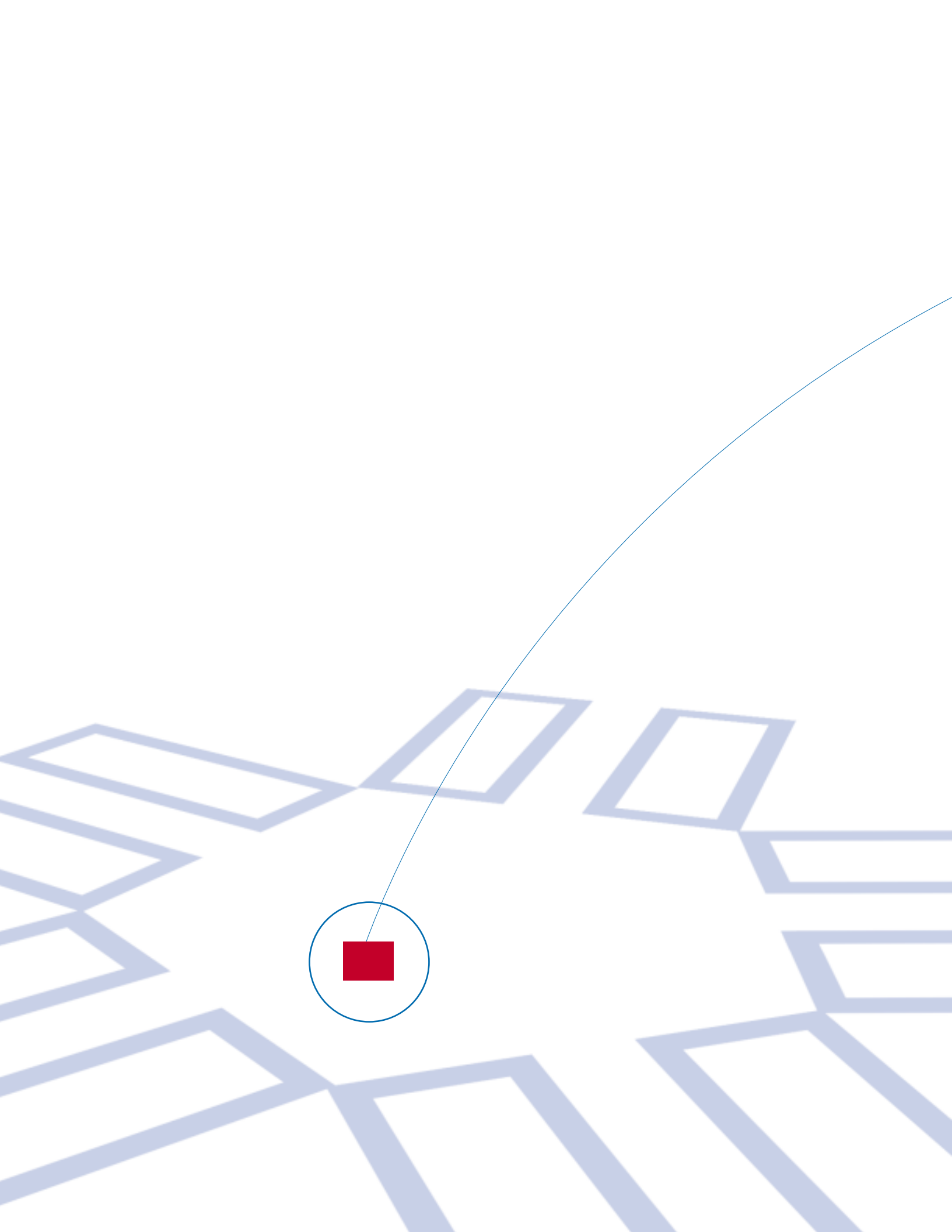
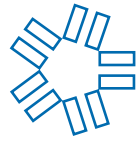

TABLE OF CONTENTS

INTRODUCTION	4
APPLICATION NOTES	6
DIELECTRIC CHARACTERISTICS	8
SMT-COG DIELECTRIC	10
SMT-X7R DIELECTRIC	12
SMT-BX DIELECTRIC	14
SMT-Z5U-Y5V DIELECTRICS	16
HIGH RELIABILITY SMT CHIPS	18
THIN PROFILE CAPACITORS	20
HIGH TEMPERATURE SMT	22
RING DETECT CAPACITORS	24
CERTIFIED SAFETY CAPACITORS	25
HIGH VOLTAGE MLC - COMMERCIAL	26
HIGH VOLTAGE MLC - HIGH RELIABILITY	29
SPECIALTY MLC PRODUCTS	32
CAPACITOR ARRAYS	34
HIGH TEMPERATURE CAPACITORS	36
RADIAL LEAD HV CAPACITORS-COMMERCIAL	38
RADIAL LEAD HV CAPACITORS-HIGH RELIABILITY	40
"ST" CAPACITOR ASSEMBLIES	42
"SWITCH'M" CAPACITOR ASSEMBLIES	44
CHIP MARKING SYSTEM	46
TAPE & REEL SYSTEM	47



NOVACAP



THE PREMIER SOURCE FOR APPLICATION SPECIFIC **MULTILAYER** CAPACITORS



NOVACAP-SYFER combines the expertise of two companies, Novacap in the USA and Syfer Technology in the UK, with twenty and thirty years of history respectively, to provide high performance surface mount components, and the broadest range of application specific multilayer capacitors available in the world. With manufacturing facilities in America and Europe, Novacap-Syfer is globally situated to provide quick support and service to the customer. Our goal is to be the premier source for specialty multilayer capacitor products.

NOVACAP is a Dover company, with over ten sister companies servicing the electronics industry with equipment and components throughout the world. NOVACAP operates from three modern manufacturing facilities occupying 93,000 square feet, located in Valencia, California. NOVACAP produces multilayer capacitors, using advanced ceramic and electrode formulations, with thin, dense and precise dielectric layers to satisfy unique and difficult requirements with unsurpassed quality. Product offerings include surface mount capacitors from the miniature 0402 size chip to larger high voltage units, rated to 20kV, for both commercial and high reliability applications, to satisfy EIA and MIL STD specifications. Products include the entire range of popular chip sizes and dielectrics, and further specializes in Application Specific Products, which include High Temperature SMT Capacitors, Thin Profile, Ring Detect, Certified Lightning Strike Capacitors, Medical Grade Capacitor Arrays, Capacitor Assemblies for switch mode power supplies, and leaded capacitors in various styles.



SYFER TECHNOLOGY is a Novacap company, with an 80,000 square foot plant located in Norwich, England, and is dedicated to the manufacture of multilayer ceramic components utilizing a state-of-the-art, fully integrated computer controlled "Wet Process" which provides products to the highest quality standards. Product offerings include surface mount MLCs, from 16V rating to 500V rating, High Voltage versions to 10KVdc, Stacked Assemblies for power supply applications, EMI Planar Arrays and Discoidals, EMI chips, EMI Feedthrough Filters, Leaded Capacitors, Varistor Arrays, and a variety of Application Specific products custom designed for your needs.

NOVACAP QUALITY POLICY

Quality at NOVACAP is conformance to requirements in all our dealings with: Our Customers - Our Vendors - Our Employees - The Environment. The system for quality is prevention of defects, and to attain continuous improvements in every activity. Every employee is committed to doing the job right, the first time.

NOVACAP maintains an ongoing education program for all of its employees, to create quality awareness, develop communication skills, provide formal capacitor processing education, and to create problem solving teams.

TECHNICAL INFORMATION

NOVACAP provides Applications Notes in this catalog as a user's guide to chip selection and attachment methods. For more details on MLC products, please refer to the NOVACAP Technical Brochure, available on the NOVACAP website. The Technical Brochure describes capacitor applications, the nature of capacitance, dielectric properties and behavior, classes of dielectrics, ferroelectric behavior, electrical properties, test standards, high reliability testing, visual criteria and detailed user guidelines. Please do not hesitate to contact the factory for any product or technical assistance.

IMPORTANT NOTICE

NOVACAP reserves the right to make changes in product designs and/or pricing. Sales are subject to the terms and conditions as defined on NOVACAP invoice and packing slips. NOVACAP has no control on conditions of use; no warranties are made or implied as to suitability for the customer's intended use. NOVACAP shall in no event be responsible for incidental or consequential damages including, without limitation, to personal injury or property damage.

WEBSITE

The NOVACAP Website outlines the product offerings in catalog format. These catalogs are updated on a routine basis, and presented in pdf format for easy viewing and downloading. All capacitance values are shown as maximum values. Please refer to the Webpage whenever you need to update your data sheets.

Web Page: www.novacap.com E-Mail: info@novacap.com

NOVACAP MAIN OFFICE

25136 Anza Drive, Valencia, CA 91355
Tel: (661) 295-5920 Fax: (661) 295-5928





CHIP SELECTION

Multilayer capacitors (MLC) are categorized by dielectric performance with temperature, or “temperature coefficient”, as these devices vary in behavior over temperature. The choice of component is thus largely determined by the temperature stability required of the device, i.e. type of dielectric, and the size necessary for a given capacitance and voltage rating. The following items are pertinent to chip selection:

DIELECTRIC TYPE

COG: Ultra stable Class I dielectric, with negligible dependence of electrical properties on temperature, voltage, frequency and time. Used in circuitry requiring very stable performance.

X7R: Stable Class II dielectric, with predictable change in properties with temperature, voltage, frequency and time. Used as blocking, de-coupling, bypassing and frequency discriminating elements. This dielectric is ferroelectric, and provides higher capacitance than Class I

Z5U/Y5V: General purpose Class III dielectrics with higher dielectric constant and greater variation of properties with temperature and test conditions. Very high capacitance per unit volume is attainable for general purpose applications where stability is not important.

CAPACITOR SIZE

Size selection is based primarily on capacitance value and voltage rating. Smaller units are generally less expensive; 0805 is the most economical size. Because mass affects the thermal shock behavior of chips, size selection must consider the soldering method used to attach the chip to the board. Sizes 1812 and smaller can be wave, vapor phase or reflow soldered. Larger units require reflow soldering.

TERMINATION MATERIAL

Nickel barrier termination, with exceptional solder leach resistance is recommended for all applications involving solder. Silver palladium termination is required for epoxy attachment, also for solder reflow below 230°C. Silver termination, which is most ductile, yet leaches readily in solder, is often preferred for units to be leaded, to minimize thermal cycle stresses.

PACKAGING

Units are available in bulk, reeled or in waffle pack. Bar coding is optional.

ATTACHMENT METHODS

Bonding of capacitors to substrates can be categorized into two methods, those involving solder, which are prevalent, and those using other materials, such as epoxies and thermo-compression or ultrasonic bonding with wire.

SOLDERING

Soldering methods commonly used in the industry and recommended are Reflow Soldering, Wave Soldering, and to a lesser extent, Vapor Phase Soldering. All these methods involve thermal cycling of the components and therefore the rate of heating and cooling must be controlled to preclude thermal shocking of the devices. In general, rates which do not exceed 100°C per minute and a ΔT spike of 100°C maximum for any soldering process is advisable. Other precautions include post soldering handling, primarily avoidance of rapid cooling with contact with heat sinks, such as conveyors or cleaning solutions.

Large chips are more prone to thermal shock as their greater bulk will result in sharper thermal gradients within the device during thermal cycling. Units larger than 1812 experience excessive stress if processed through the fast cycles typical of solder wave or vapor phase operations. Solder reflow is most applicable to the larger chips as the rates of heating and cooling can be slowed within safe limits.

Attachment using a soldering iron requires extra care, particularly with large components, as thermal gradients are not easily controlled and may cause cracking of the chip. Precautions include preheating of the assembly to within 100°C of the solder flow temperature, the use of a fine tip iron which does not exceed 30 watts, and limitation of contact of the iron to the circuit pad areas only.

BONDING

Hybrid assembly using conductive epoxy or wire bonding requires the use of silver palladium or gold terminations. Nickel barrier termination is not practical in these applications, as an increase in ESR results.

CLEANING

Chip capacitors can withstand common agents such as water, alcohol and degreaser solvents used for cleaning boards. Ascertain that no flux residues are left on the chip surfaces as these diminish electrical performance.





BOARD DESIGN CONSIDERATIONS

The amount of solder applied to the chip capacitor will influence the reliability of the device. Excessive solder can create thermal and tensile stresses on the component which could lead to fracturing of the chip or the solder joint itself. Insufficient or uneven solder application can result in weak bonds, rotation of the device off line or lifting of one terminal off the pad (tombstoning).

The volume of solder is process and board pad size dependent. WAVE SOLDERING exposes the devices to a large solder volume, hence the pad size area must be restricted to accept an amount of solder which is not detrimental to the chip size utilized. Typically the pad width is 66% of the component width, and the length is .030" (.760 mm) longer than the termination band on the chip. An 0805 chip which is .050" wide and has a .020" termination band therefore requires a pad .033" wide by .050" in length. Opposing pads should be identical in size to preclude uneven solder fillets and mismatched surface tension forces which can misalign the device. It is preferred that the pad layout results in alignment of the long axis of the chips at right angles to the solder wave, to promote even wetting of all terminals. Orientation of components in line with the board travel direction may require dual waves with solder turbulence to preclude cold solder joints on the trailing terminals of the devices, as these are blocked from full exposure to the solder by the body of the capacitor.

Restrictions in chip alignment do not apply to SOLDER REFLOW or VAPOR PHASE processes, where the solder volume is controlled by the solder paste deposition on the circuit pads. Pads are designed to match or slightly exceed the width of the capacitor, with length .030" (.760 mm) greater than the chip terminal band width, to provide a wetting area for a full solder fillet.

SOLDER ATTACHMENT RECOMMENDED PROFILES

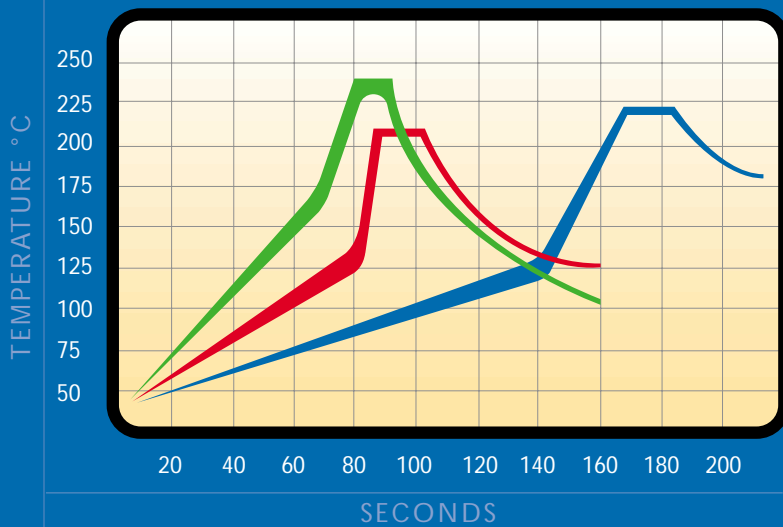

SOLDER WAVE **VAPOR PHASE** **SOLDER REFLOW**

RECOMMENDATIONS

Preheat/Cooling rates not to exceed 120°C/minute.
DT spikes to max temperature not to exceed 100°C

NOVACAP publishes a Technical Brochure which provides detailed information on the properties of ceramic chip capacitors, dielectric behavior, product classifications, test and quality standards, and other information relevant to their use. The NOVACAP Technical Brochure is available upon request. For quick reference see the Brochure on the NOVACAP Website at www.novacap.com.



DIELECTRIC CHARACTERISTICS



NOVACAP produces capacitors with dielectric characteristics COG (NPO), X7R, BX, Z5U and Y5V, per EIA RS 198, as outlined in the text and graphs following. High temperature versions of COG and X7R dielectrics are described in separate data sheets for those products.

NOVACAP performs routine testing on production representative products, for all dielectric materials, as verification of conformance to the General Specifications. Following the guidelines of MIL-PRF-55681; periodic Group C inspections are performed on capacitor lots manufactured, with qualified materials, according to documented procedures. The inspection data is generated following Electrical, Mechanical and Environmental test methods and specifications of MIL-STD-202 and EIA-198. The data records are maintained and utilized as assurance of our capability to meet the stated performance requirements.

GENERAL SPECIFICATIONS - ENVIRONMENTAL

Thermal Shock:	MIL-STD-202, Method 107, Condition A (125°C)
Immersion:	MIL-STD-202, Method 104, Condition B
Humidity Steady State (Low Voltage):	MIL-STD-202, Method 103, Condition A 85°C, 85% RH, DC bias 1.3 +/- 0.25 Vdc.
Life:	MIL-STD-202, Method 108 Condition F (2,000 Hrs).

GENERAL SPECIFICATIONS - MECHANICAL

Terminal Strength:	MIL-STD-202, Method 211 Condition A. Force 4 lbs Min. Adhesion
Solderability:	MIL-STD-202, Method 208.
Resistance to Soldering Heat:	MIL-STD-202, Method 210, Test Condition B.



DIELECTRIC CHARACTERISTICS - COG

OPERATING TEMPERATURE RANGE:	-55°C to 125°C
TEMPERATURE COEFFICIENT:	0 +/- 30 ppm/°C
DISSIPATION FACTOR:	.001 (0.1%) max @ 25°C
INSULATION RESISTANCE, 25°C	> 100GΩ or >1000ΩF
125°C	> 10GΩ or >100ΩF
DIELECTRIC WITHSTANDING VOLTAGE:	< 200V, 250%
* WHICHEVER IS GREATER	201-500V, 150% or 500V* > 500V, 120%, or 750V*
AGING RATE:	0% per decade
TEST PARAMETERS:	1KHz, 1.0 +/- 0.2 VRMS, 25°C 1MHZ for Capacitance <100pF

TEMPERATURE COEFFICIENT

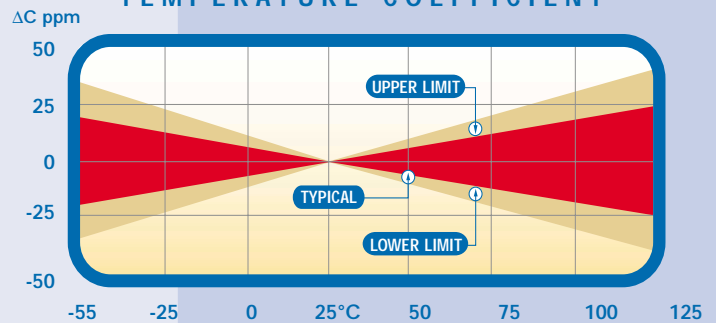

DIELECTRIC CHARACTERISTICS - X7R/BX

OPERATING TEMPERATURE RANGE:	-55°C to 125°C
TEMPERATURE COEFFICIENT:	+/-15% ΔC Max.
TEMP-VOLTAGE COEFFICIENT (BX):	+15% -25% ΔC Max.
DISSIPATION FACTOR:	2.5% max @ >25V rating 3.5% max @ <25V rating
INSULATION RESISTANCE, 25°C 125°C	> 100GΩ or >1000ΩF > 10GΩ or >100ΩF
DIELECTRIC WITHSTANDING VOLTAGE: * WHICHEVER IS GREATER	< 200V, 250% 201-500V, 150% or 500V* > 500V, 120%, or 750V*
AGING RATE:	< 2.0% per decade
TEST PARAMETERS:	1KHz, 1.0 +/- 0.2 VRMS, 25°C

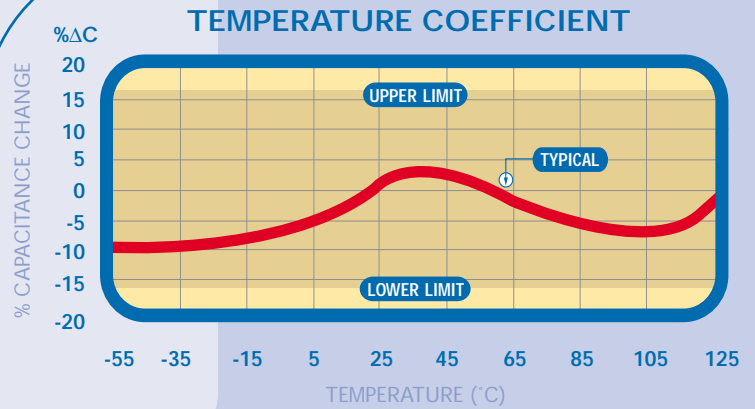

DIELECTRIC CHARACTERISTICS - Z5U

OPERATING TEMPERATURE RANGE:	+ 10°C to 85°C
TEMPERATURE COEFFICIENT:	+ 22%-56% ΔC Max.
DISSIPATION FACTOR:	4.0% max @ 25°C
INSULATION RESISTANCE, 25°C	> 10GΩ or >100ΩF
DIELECTRIC WITHSTANDING VOLTAGE:	< 200V, 250% 250V, 150%
AGING RATE:	~ 2.0% per decade
TEST PARAMETERS:	1KHz, 0.5 +/- 0.2 VRMS, 25°C

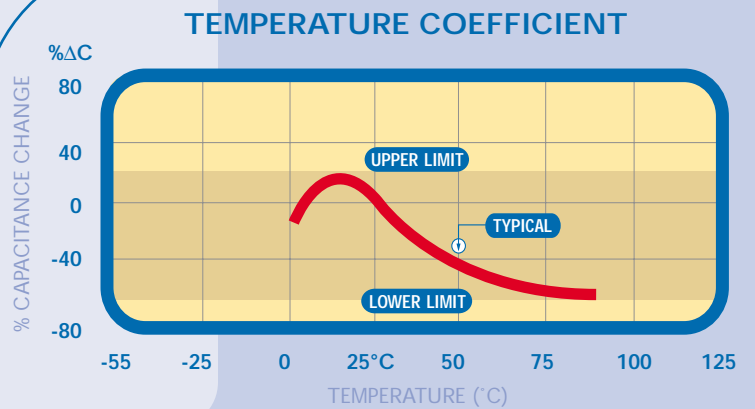

DIELECTRIC CHARACTERISTICS - Y5V

OPERATING TEMPERATURE RANGE:	-30°C to 85°C
TEMPERATURE COEFFICIENT:	+ 22%-82% ΔC Max.
DISSIPATION FACTOR:	5.0% max @ >25V rating 7.0% max @ <25V rating
INSULATION RESISTANCE, 25°C	> 10GΩ or >100ΩF
DIELECTRIC WITHSTANDING VOLTAGE:	< 200V, 250% 250V, 150%
AGING RATE:	~ 2.0% per decade
TEST PARAMETERS:	1KHz, 0.5 +/- 0.2 VRMS, 25°C

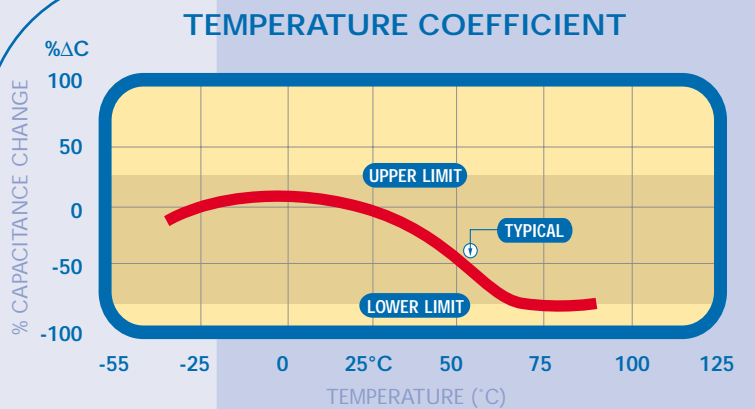



SMT-COG DIELECTRIC



Ultra stable Class I dielectric (EIA COG) or NPO:

linear temperature coefficient, low loss, stable electrical properties with time, voltage and frequency. Designed for surface mount application with nickel barrier termination

suitable for solder wave, vapor phase or reflow solder board attachment. Also avail-

able with silver-palladium terminations for hybrid use with conductive epoxy.

COG chips are used in precision circuitry requiring Class I stability.



➔ CAPACITANCE & VOLTAGE SELECTION FOR POPULAR CHIP SIZES

3 digit code: two significant digits, followed by number of zeros eg: 183 = 18,000 pF. R denotes decimal, eg. 2R7 = 2.7 pF

MAX CAP & VOLTAGE

SIZE	0402	0504	0603	0805	1005	1206	1210	1808	1812	1825	2221	2225
Min Cap	0R1	0R1	0R1	0R1	0R1	0R5	3R0	100	150	390	390	390
16V	271	182	102	472	682	153	273	333	393	823	823	104
25V	221	122	821	392	562	123	223	273	393	823	823	104
50V	181	102	681	332	472	103	223	223	333	823	823	104
100V	101	561	331	182	222	562	103	123	183	563	563	683
200V	680	391	271	122	182	392	822	103	123	393	393	473
250V	470	271	181	821	122	272	562	682	822	273	273	333
300V	•	•	•	561	821	182	392	472	682	183	183	223
400V	•	•	•	561	821	152	272	332	472	123	123	153
500V	•	•	•	471	681	102	222	272	392	123	103	153
600V	•	•	•	471	681	102	222	222	332	103	822	123
800V*	•	•	•	471	681	102	222	182	272	822	822	103
1000V*	•	•	•	331	471	821	182	152	222	822	822	103
1500V*	•	•	•	•	•	561	122	122	222	682	682	822
2000V*	•	•	•	•	•	271	681	821	122	392	392	472
3000V*	•	•	•	•	•	•	•	331	561	182	182	222
4000V*	•	•	•	•	•	•	•	181	331	102	102	122

*Units rated above 800V may require conformal coating in use to preclude arcing over the chip surface.



See chart for standard EIA case sizes and available capacitance and voltage ratings. Special sizes, thickness and other voltage ratings are available, see other NOVACAP product offerings. High reliability testing is available per MIL-PRF-55681, MIL-PRF-123, or to customer SCD. Please consult the factory with your requirements. NOVACAP has complete testing facilities at your disposal.

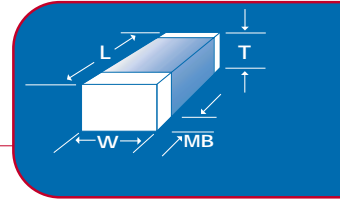

DIMENSIONS +/- INCHES (MM)

SIZE	0402	0504	0603	0805	1005	1206	1210	1808	1812	1825	2221	2225
LENGTH L	.040 (1.02)	.050 (1.27)	.060 (1.52)	.080 (2.03)	.100 (2.54)	.125 (3.18)	.125 (3.18)	.180 (4.57)	.180 (4.57)	.180 (4.57)	.220 (5.59)	.220 (5.59)
WIDTH W	.020 (.508)	.040 (1.02)	.030 (.760)	.050 (1.27)	.050 (1.27)	.060 (1.52)	.100 (2.54)	.080 (2.03)	.125 (3.18)	.250 (6.35)	.210 (5.33)	.250 (6.35)
T MAX.	.024 (.610)	.044 (1.12)	.035 (.889)	.054 (1.37)	.054 (1.37)	.064 (1.63)	.065 (1.65)	.065 (1.65)	.065 (1.65)	.080 (2.03)	.080 (2.03)	.080 (2.03)
MB	.010 (.254)	.014 (.355)	.014 (.355)	.020 (.508)	.020 (.508)	.020 (.508)	.020 (.508)	.024 (.610)	.024 (.610)	.024 (.610)	.030 (.760)	.030 (.760)

TOLERANCES +/- INCHES (MM)

LENGTH	.004 (.102)	.006 (.152)	.006 (.152)	.008 (.203)	.008 (.203)	.008 (.203)	.008 (.203)	.012 (.305)	.012 (.305)	.012 (.305)	.015 (.380)	.015 (.380)
WIDTH	.004 (.102)	.006 (.152)	.006 (.152)	.008 (.203)	.008 (.203)	.008 (.203)	.008 (.203)	.008 (.203)	.008 (.203)	.015 (.380)	.015 (.380)	.015 (.380)
MB	.006 (.152)	.006 (.152)	.006 (.152)	.010 (.254)	.010 (.254)	.010 (.254)	.010 (.254)	.014 (.355)	.014 (.355)	.014 (.355)	.015 (.380)	.015 (.380)

HOW TO ORDER

1206	N	272	J	101	N	X	T	M
SIZE See Chart	DIELECTRIC N = COG	CAPACITANCE Value in Picofarads Two significant figures, followed by number of zeros: 272 = 2700 pF	TOLERANCE B = 0.10 pF (0.1 to 10 pF) C = 0.25 pF (0.1 to 10 pF) D = 0.50 pF (0.1 to 20 pF) F = +/- 1.0 % G = +/- 2.0 % H = +/- 3.0 % J = +/- 5.0 % K = +/- 10 % M = +/- 20 % Z = +80% -20% P = +100% -0%	VOLTAGE-VDCW Two significant figures, followed by number of zeros: 101 = 100V	TERMINATION N = Nickel Barrier P = Ag-Pd	THICKNESS OPTION X = Non standard thickness. Specify in Mils if Non EIA thickness is required.	PACKING OPTION T = Reeled	MARKING OPTION M = Marked (See Marking Specifications)



SMT-X7R DIELECTRIC



Stable EIA Class II dielectric, with +/-15% temperature coefficient and predictable variation of electrical properties with time, temperature and voltage. These chips are designed for surface mount application with nickel barrier terminations suitable for solder wave, vapor phase or reflow solder board attachment. Also available in silver-palladium terminations for hybrid use with conductive epoxy. Class II X7R chips are used as decoupling, by-pass, filtering and transient voltage suppression elements.

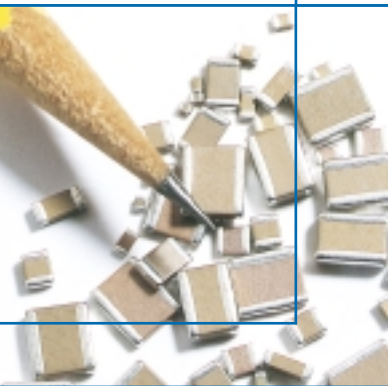

CAPACITANCE & VOLTAGE SELECTION FOR POPULAR CHIP SIZES

3 digit code: two significant digits, followed by number of zeros eg: 473 = 47,000 pF

SIZE	0402	0504	0603	0805	1005	1206	1210	1808	1812	1825	2221	2225
Min Cap	121	121	121	121	121	121	121	121	391	821	821	821
16V	682	393	273	124	184	334	684	824	125	185	185	225
25V	562	273	183	104	124	274	564	684	105	185	155	185
50V	562	273	183	104	124	224	474	564	824	155	155	185
100V	272	153	103	563	683	124	274	334	564	155	125	155
200V	182	103	682	333	473	823	184	224	334	105	824	105
250V	182	103	682	273	393	563	124	154	334	564	684	105
300V	•	•	•	223	333	563	124	124	224	564	564	684
400V	•	•	•	153	223	473	104	124	184	474	394	564
500V	•	•	•	103	153	273	563	563	104	274	274	334
600V	•	•	•	822	123	223	473	563	823	224	224	274
800V*	•	•	•	472	682	123	273	333	473	154	154	184
1000V*	•	•	•	272	472	682	153	183	273	823	104	124
1500V*	•	•	•	•	•	222	472	562	822	273	273	333
2000V*	•	•	•	•	•	102	222	272	392	153	153	183
3000V*	•	•	•	•	•	•	•	821	122	472	472	562
4000V*	•	•	•	•	•	•	•	391	561	222	222	272

MAX CAP & VOLTAGE

*Units rated above 800V may require conformal coating in use to preclude arcing over the chip surface.

PRODUCT OFFERING



See chart for standard EIA case sizes and available capacitance and voltage ratings. Special sizes, thickness and other voltage ratings are available, see other NOVACAP product offerings. High reliability testing is available per MIL-PRF-55681, MIL-PRF-123, or to customer SCD. Please consult the factory with your requirements. NOVACAP has complete testing facilities at your disposal.

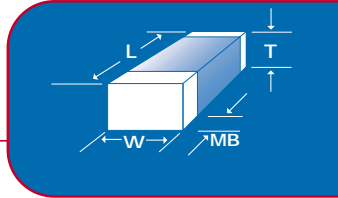

DIMENSIONS +/- INCHES (MM)

SIZE	0402	0504	0603	0805	1005	1206	1210	1808	1812	1825	2221	2225
LENGTH L	.040 (1.02)	.050 (1.27)	.060 (1.52)	.080 (2.03)	.100 (2.54)	.125 (3.18)	.125 (3.18)	.180 (4.57)	.180 (4.57)	.180 (4.57)	.220 (5.59)	.220 (5.59)
WIDTH W	.020 (.508)	.040 (1.02)	.030 (.760)	.050 (1.27)	.050 (1.27)	.060 (1.52)	.100 (2.54)	.080 (2.03)	.125 (3.18)	.250 (6.35)	.210 (5.33)	.250 (6.35)
T MAX.	.024 (.610)	.044 (1.12)	.035 (.889)	.054 (1.37)	.054 (1.37)	.064 (1.63)	.065 (1.65)	.065 (1.65)	.065 (1.65)	.080 (2.03)	.080 (2.03)	.080 (2.03)
MB	.010 (.254)	.014 (.355)	.014 (.355)	.020 (.508)	.020 (.508)	.020 (.508)	.020 (.508)	.024 (.610)	.024 (.610)	.024 (.610)	.030 (.760)	.030 (.760)

TOLERANCES +/- INCHES (MM)

LENGTH	.004 (.102)	.006 (.152)	.006 (.152)	.008 (.203)	.008 (.203)	.008 (.203)	.008 (.203)	.012 (.305)	.012 (.305)	.012 (.305)	.015 (.380)	.015 (.380)
WIDTH	.004 (.102)	.006 (.152)	.006 (.152)	.008 (.203)	.008 (.203)	.008 (.203)	.008 (.203)	.008 (.203)	.008 (.203)	.015 (.380)	.015 (.380)	.015 (.380)
MB	.006 (.152)	.006 (.152)	.006 (.152)	.010 (.254)	.010 (.254)	.010 (.254)	.010 (.254)	.014 (.355)	.014 (.355)	.014 (.355)	.015 (.380)	.015 (.380)

HOW TO ORDER

1206	B	104	J	250	N	X	T	M
SIZE See Chart	DIELECTRIC B = X7R	CAPACITANCE Value in Picofarads Two significant figures, followed by number of zeros: 104 = 100,000pF	TOLERANCE J = +/- 5.0% K = +/- 10 % M = +/- 20 % Z = +80%-20% P = +100%-0%	VOLTAGE-VDCW Two significant figures, followed by number of zeros: 250 = 25V	TERMINATION N = Nickel Barrier P = Ag-Pd	THICKNESS OPTION X = Non standard thickness. Specify in Mils if Non EIA thickness is required.	PACKING OPTION T = Reeled	MARKING OPTION M = Marked (See Marking Specifications)



SMT - BX DIELECTRIC



BX characteristics are identical to X7R dielectric, with the added restriction that the Temperature-Voltage Coefficient (TVC) is not to exceed $-25\% \Delta C$ at rated voltage, over the operating temperature range (-55°C to

125°C). NOVACAP manufactures chips using dielectrics with minimal voltage coefficient and layer thickness design to meet BX requirements.

BX dielectric code is X.



➔ CAPACITANCE & VOLTAGE SELECTION FOR POPULAR CHIP SIZES

3 digit code: two significant digits, followed by number of zeros eg: 473 = 47,000 pF

SIZE	0402	0504	0603	0805	1005	1206	1210	1808	1812	1825	2221	2225
Min Cap	121	121	121	121	121	121	121	221	471	821	821	821
16V	682	393	273	124	184	334	684	824	125	185	185	225
25V	562	273	183	104	124	274	564	684	105	185	185	185
50V	222	123	822	393	563	124	224	274	474	125	125	155
100V	471	472	272	123	183	393	683	823	124	334	334	394
200V	151	122	681	272	392	681	183	183	333	823	823	104
250V	121	681	331	222	332	682	123	153	273	683	683	823
300V	•	•	•	152	222	392	103	103	183	473	473	563
400V	•	•	•	681	102	182	472	562	103	273	273	273
500V	•	•	•	561	102	182	392	392	682	183	183	223

MAX CAP & VOLTAGE



PRODUCT OFFERING



See chart for standard EIA case sizes and available capacitance and voltage ratings. Special sizes, thickness and other voltage ratings are available, see other NOVACAP product offerings. High reliability testing is available per MIL-PRF-55681, MIL-PRF-123, or to customer SCD. Please consult the factory with your requirements. NOVACAP has complete testing facilities at your disposal.

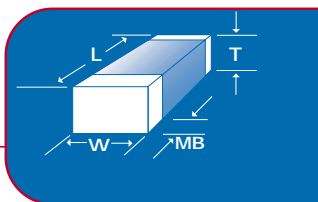

→ DIMENSIONS +/- INCHES (MM)

SIZE	0402	0504	0603	0805	1005	1206	1210	1808	1812	1825	2221	2225
LENGTH L	.040 (1.02)	.050 (1.27)	.060 (1.52)	.080 (2.03)	.100 (2.54)	.125 (3.18)	.125 (3.18)	.180 (4.57)	.180 (4.57)	.180 (4.57)	.220 (5.59)	.220 (5.59)
WIDTH W	.020 (.508)	.040 (1.02)	.030 (.760)	.050 (1.27)	.050 (1.27)	.060 (1.52)	.100 (2.54)	.080 (2.03)	.250 (6.35)	.250 (6.35)	.210 (5.33)	.250 (6.35)
T MAX.	.024 (.610)	.044 (1.12)	.035 (.889)	.054 (1.37)	.054 (1.37)	.064 (1.63)	.065 (1.65)	.065 (1.65)	.080 (2.03)	.080 (2.03)	.080 (2.03)	.080 (2.03)
MB	.010 (.254)	.014 (.355)	.014 (.355)	.020 (.508)	.020 (.508)	.020 (.508)	.020 (.508)	.024 (.610)	.024 (.610)	.024 (.610)	.030 (.760)	.030 (.760)

→ TOLERANCES +/- INCHES (MM)

LENGTH	.004 (.102)	.006 (.152)	.006 (.152)	.008 (.203)	.008 (.203)	.008 (.203)	.008 (.203)	.012 (.305)	.012 (.305)	.012 (.305)	.015 (.380)	.015 (.380)
WIDTH	.004 (.102)	.006 (.152)	.006 (.152)	.008 (.203)	.008 (.203)	.008 (.203)	.008 (.203)	.008 (.203)	.008 (.203)	.015 (.380)	.015 (.380)	.015 (.380)
MB	.006 (.152)	.006 (.152)	.006 (.152)	.010 (.254)	.010 (.254)	.010 (.254)	.010 (.254)	.014 (.355)	.014 (.355)	.014 (.355)	.015 (.380)	.015 (.380)

→ HOW TO ORDER

1206	X	104	J	250	N	X	T	M
SIZE See Chart	DIELECTRIC X = BX	CAPACITANCE Value in Picofarads Two significant figures, followed by number of zeros: 104 = 100,000pF	TOLERANCE J = +/- 5.0% K = +/- 10% M = +/- 20%	VOLTAGE-VDCW Two significant figures, followed by number of zeros: 250 = 25V	TERMINATION N = Nickel Barrier P = Ag-Pd	THICKNESS OPTION X = Non standard thickness. Specify in Mils if Non EIA thickness is required.	PACKING OPTION T = Reeled	MARKING OPTION M = Marked (See Marking Specifications)



SMT-Z5U-Y5V DIELECTRICS



General purpose EIA Class III dielectrics with +22% to -56% (Z5U) and +22% -82% (Y5V) temperature coefficients and very high capacitance density. The NOVACAP Z5U and Y5V formulations are very stable with time, typically aging less than 2% per decade. General purpose chips are used in by-pass and decoupling functions and other applications where capacitance change over the operating temperature range is not critical.

➔ CAPACITANCE & VOLTAGE SELECTION FOR POPULAR CHIP SIZES

3 digit code: two significant digits, followed by number of zeros eg: 473 = 47,000 pF

Z5U DIELECTRIC

SIZE	0402	0504	0603	0805	1005	1206	1210	1808	1812	1825	2221	2225
Min Cap	121	121	121	391	561	561	561	182	272	822	822	822
16V	333	184	154	684	824	155	335	395	565	106	156	106
25V	273	154	104	474	684	125	225	335	475	106	126	106
50V	183	104	683	334	474	105	185	225	395	825	106	825
100V	472	393	273	124	184	274	564	684	125	225	335	225
200V	152	103	562	333	393	823	184	224	394	824	125	105
250V	102	682	472	223	333	563	124	154	224	684	824	684

MAX CAP & VOLTAGE

Y5V DIELECTRIC

SIZE	0402	0504	0603	0805	1005	1206	1210	1808	1812	1825	2221	2225
Min Cap	121	121	121	471	681	681	681	222	332	103	103	103
16V	393	224	184	824	105	185	395	475	685	126	126	186
25V	333	184	124	564	824	155	275	395	565	126	126	156
50V	223	124	823	394	564	125	225	275	475	106	106	126
100V	562	473	333	154	224	334	684	824	155	275	275	395
200V	182	123	682	393	473	104	224	274	474	105	125	155
250V	122	822	562	273	393	683	154	184	274	824	824	105

MAX CAP & VOLTAGE

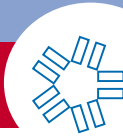

PRODUCT OFFERING



See chart for standard EIA case sizes and available capacitance and voltage ratings. The low aging rate of the Novacap dielectrics permits the manufacture of Z5U and Y5V chips with K (+/-10%) capacitance tolerance, as well as the M, Z and P tolerance offerings. Special sizes, thickness and other voltage ratings are available, see other NOVACAP product offerings. Please consult the factory with your requirements.

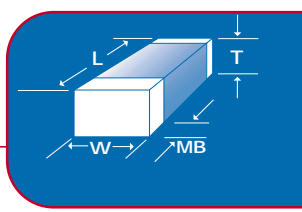

DIMENSIONS +/- INCHES (MM)

SIZE	0402	0504	0603	0805	1005	1206	1210	1808	1812	1825	2221	2225
LENGTH L	.040 (1.02)	.050 (1.27)	.060 (1.52)	.080 (2.03)	.100 (2.54)	.125 (3.18)	.125 (3.18)	.180 (4.57)	.180 (4.57)	.180 (4.57)	.220 (5.59)	.220 (5.59)
WIDTH W	.020 (.508)	.040 (1.02)	.030 (.760)	.050 (1.27)	.050 (1.27)	.060 (1.52)	.100 (2.54)	.080 (2.03)	.125 (3.18)	.250 (6.35)	.210 (5.33)	.250 (6.35)
T MAX.	.024 (.610)	.044 (1.12)	.035 (.889)	.054 (1.37)	.054 (1.37)	.064 (1.63)	.065 (1.65)	.065 (1.65)	.065 (1.65)	.080 (2.03)	.080 (2.03)	.080 (2.03)
MB	.010 (.254)	.014 (.355)	.014 (.355)	.020 (.508)	.020 (.508)	.020 (.508)	.020 (.508)	.024 (.610)	.024 (.610)	.024 (.610)	.030 (.760)	.030 (.760)

TOLERANCES +/- INCHES (MM)

LENGTH	.004 (.102)	.006 (.152)	.006 (.152)	.008 (.203)	.008 (.203)	.008 (.203)	.008 (.203)	.012 (.305)	.012 (.305)	.012 (.305)	.015 (.380)	.015 (.380)
WIDTH	.004 (.102)	.006 (.152)	.006 (.152)	.008 (.203)	.008 (.203)	.008 (.203)	.008 (.203)	.008 (.203)	.008 (.203)	.015 (.380)	.015 (.380)	.015 (.380)
MB	.006 (.152)	.006 (.152)	.006 (.152)	.010 (.254)	.010 (.254)	.010 (.254)	.010 (.254)	.014 (.355)	.014 (.355)	.014 (.355)	.015 (.380)	.015 (.380)

HOW TO ORDER

	1206	Y	104	M	250	N	X	T	M
SIZE See Chart									
DIELECTRIC		Z = Z5U Y = Y5V							
CAPACITANCE			Value in Picofarads Two significant figures, followed by number of zeros: 104 = 100,000pF						
TOLERANCE				K = +/- 10% M = +/- 20% Z = +80% -20% P = +100% -0%					
VOLTAGE-VDCW					Two significant figures, followed by number of zeros: 250 = 25V				
TERMINATION						N = Nickel Barrier 90/10 Sn/Pb V = Non solderable Silver			
THICKNESS OPTION							X = Non standard thickness. Specify in Mils if Non EIA thickness is required.		
PACKING OPTION								T = Reeled	
MARKING OPTION									M = Marked (See Marking Specifications)



HIGH RELIABILITY SMT CHIPS



NOVACAP manufactures and tests COG, BX and X7R chips in accordance with MIL-PRF-55681, MIL-PRF-123, MIL-PRF-49467, HALT, or customer SCD. Product is designed for optimum reliability, burned in at elevated voltage and temperature, and 100% physically and electrically inspected to ascertain conformance to strict performance criteria. Voltage ratings from 25 VDC to 500 VDC are available on standard EIA case sizes. Applications for High Reliability products include medical implanted devices, aerospace, airborne and various military applications, and consumer uses requiring safety margins not attainable with conventional product. High voltage conditioning up to 20 KV for specialty devices is also available, please refer to other NOVACAP product offerings.



CAPACITANCE SELECTION FOR FR-P

PARTS MEETING FR-R AND FR-S ARE ALSO AVAILABLE

3 digit code: two significant digits, followed by number of zeros eg: 183 = 18,000 pF

COG DIELECTRIC

SIZE	0402	0504	0603	0805	1005	1206	1210	1808	1812	1825	2221	2225
Min Cap	0R1	0R1	0R1	0R1	1R0	1R0	5R0	100	100	270	270	270
25V	121	681	331	222	472	822	183	223	333	823	823	104
50V	121	681	331	222	472	822	153	223	333	823	823	104
100V	680	391	181	122	222	472	103	123	183	563	563	683
250V	330	151	101	821	122	182	392	472	682	223	223	273
500V	•	•	•	471	681	102	222	222	392	123	123	153

MAX CAP & VOLTAGE

X7R/BX DIELECTRIC

SIZE	0402		0504		0603		0805		1005		1206		1210		1808		1812		1825		2221		2225	
Min Cap	121		121		121		121		121		121		121		151		271		471		561		681	
	X7R	BX	X7R	BX	X7R	BX	X7R	BX	X7R	BX	X7R	BX	X7R	BX	X7R	BX	X7R	BX	X7R	BX	X7R	BX	X7R	BX
25V	332	332	183	183	822	822	563	563	104	104	184	184	394	394	474	474	824	824	185	185	155	155	185	185
50V	272	122	153	562	682	272	473	273	823	393	154	683	334	154	394	224	684	334	185	824	155	824	185	105
100V	222	471	123	472	562	272	393	123	683	183	104	393	224	683	274	823	564	124	125	334	105	334	125	394
250V	471	•	272	681	182	331	123	182	183	332	273	682	563	123	563	153	104	273	274	683	224	683	274	823
500V	•	•	•	•	•	•	392	561	562	102	103	182	223	332	223	392	393	682	124	183	124	183	154	223

MAX CAP & VOLTAGE

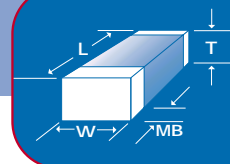

DIMENSIONS +/- INCHES (MM)

SIZE	0402	0504	0603	0805	1005	1206	1210	1808	1812	1825	2221	2225
LENGTH L	.040 (1.02)	.050 (1.27)	.060 (1.52)	.080 (2.03)	.100 (2.54)	.125 (3.18)	.125 (3.18)	.180 (4.57)	.180 (4.57)	.180 (4.57)	.220 (5.59)	.220 (5.59)
WIDTH W	.020 (.508)	.040 (1.02)	.030 (.760)	.050 (1.27)	.050 (1.27)	.060 (1.52)	.100 (2.54)	.080 (2.03)	.125 (3.18)	.250 (6.35)	.210 (5.33)	.250 (6.35)
T MAX.	.024 (.610)	.044 (1.12)	.035 (.889)	.054 (1.37)	.054 (1.37)	.064 (1.63)	.065 (1.65)	.065 (1.65)	.065 (1.65)	.080 (2.03)	.080 (2.03)	.080 (2.03)
MB	.010 (.254)	.014 (.355)	.014 (.355)	.020 (.508)	.020 (.508)	.020 (.508)	.020 (.508)	.024 (.610)	.024 (.610)	.024 (.610)	.030 (.760)	.030 (.760)

TOLERANCES +/- INCHES (MM)

LENGTH	.004 (.102)	.006 (.152)	.006 (.152)	.008 (.203)	.008 (.203)	.008 (.203)	.008 (.203)	.012 (.305)	.012 (.305)	.012 (.305)	.015 (.380)	.015 (.380)
WIDTH	.004 (.102)	.006 (.152)	.006 (.152)	.008 (.203)	.008 (.203)	.008 (.203)	.008 (.203)	.008 (.203)	.008 (.203)	.015 (.380)	.015 (.380)	.015 (.380)
MB	.006 (.152)	.006 (.152)	.006 (.152)	.010 (.254)	.010 (.254)	.010 (.254)	.010 (.254)	.014 (.355)	.014 (.355)	.014 (.355)	.015 (.380)	.015 (.380)

MIL-PRF SCREENING FLOWCHARTS

MIL-PRF-55681 (GROUP A)	MIL-PRF-123 (GROUP A)	MIL-PRF-49467 (GROUP A)
100% ELECTRICALS	THERMAL SHOCK	THERMAL SHOCK
DPA	VOLTAGE CONDITIONING 168 HRS, 2X VDCW, 125°C	DWV
VISUAL INSPECTION	VISUAL & MECH. INSPECTION	VOLTAGE CONDITIONING 96 HRS, VDCW, 125°C
VOLTAGE CONDITIONING 100 HRS, 2X VDCW, 125°C	DPA	PARTIAL DISCHARGE
DWV, IR, HOT IR, CAP, DF TEST	DWV, IR, CAP, DF TEST	CAP, DF, DWV, IR TESTING
VISUAL & MECH. INSPECTION		VISUAL & MECH. INSPECTION
SOLDERABILITY		SOLDERABILITY
B & C ENVIRONMENTAL & LIFE TEST	B & C ENVIRONMENTAL & LIFE TEST	B & C ENVIRONMENTAL & LIFE TEST

HOW TO ORDER

1210	X	104	M	250	N	X	H	T	M
SIZE See Chart	DIELECTRIC N = NPO X = BX B = X7R	CAPACITANCE Value in Picofarads Two significant figures, followed by number of zeros: 104 = 100,000pF	TOLERANCE F = +/- 1% G = +/- 2% COG only J = +/- 5% K = +/- 10% M = +/- 20%	VOLTAGE-VDCW Two significant figures, followed by number of zeros: 250 = 25V	TERMINATION N = Nickel Barrier 90/10 Sn/Pb P = Silver Palladium	THICKNESS OPTION X = Non standard thickness. Specify in Mils if Non EIA thickness is required.	HI REL TESTING Specify Test Criteria	PACKING OPTION T = Reeled	MARKING OPTION M = Marked (See Marking Specifications)



THIN PROFILE CAPACITORS



Popular EIA size chips are offered in very thin profile configuration with COG, X7R, Z5U and Y5V dielectric characteristics rated at 5 Vdc to 50 Vdc, for use as decoupling capacitors under other circuit elements, or for low profile RFID and "Smart Card" circuitry.

MAX CAPACITANCE AT DISCRETE THICKNESS

3 digit code: two significant digits, followed by number of zeros

eg: 472= 4700 pF. R denotes decimal, eg. 2R7 = 2.7 pF

SIZE	0805	1206	1210
LENGTH L	.080 (2.03)	.125 (3.18)	.125 (3.18)
WIDTH W	.050 (1.27)	.060 (1.52)	.100 (2.54)
MB	.020 (.508)	.020 (.508)	.020 (.508)

MAXIMUM THICKNESS

INCHES	.012	.015	.018	.015	.018	.020	.015	.018	.020
MM	.305	.381	.457	.381	.457	.508	.381	.457	.508

COG DIELECTRIC

Min Cap	0R1	0R1	0R1	0R5	0R5	0R5	3R0	3R0	3R0
5V	122	182	222	472	562	682	822	103	123
16V	821	122	152	332	392	472	392	682	822
25V	681	102	122	272	332	392	472	562	682
50V	471	821	102	182	272	272	332	472	562

X7R DIELECTRIC

Min Cap	121	121	121	121	121	121	121	121	121
5V	223	273	473	683	823	104	124	184	184
16V	223	273	393	683	823	104	124	154	184
25V	153	223	273	563	683	823	104	124	154
50V	123	183	223	333	563	683	823	104	124

MAX CAP @ VOLTAGE

DIMENSIONAL TOLERANCES +/- INCHES (MM)

LENGTH L	.008 (.203)	.008 (.203)	.008 (.203)
WIDTH W	.008 (.203)	.008 (.203)	.008 (.203)
MB	.010 (.254)	.010 (.254)	.010 (.254)

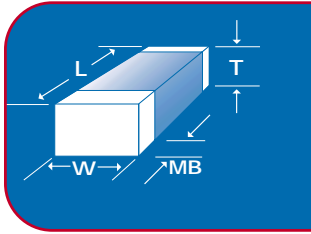

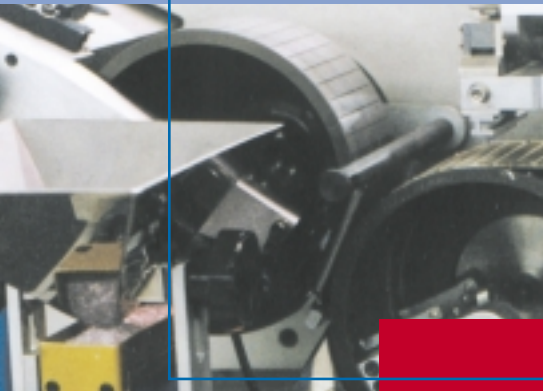

MAX CAPACITANCE AT DISCRETE THICKNESS
(continued)

SIZE	0805			1206			1210		
LENGTH L	.080 (2.03)			.125 (3.18)			.125 (3.18)		
WIDTH W	.050 (1.27)			.060 (1.52)			.100 (2.54)		
MB	.020 (.508)			.020 (.508)			.020 (.508)		
MAXIMUM THICKNESS									
INCHES	.012	.015	.018	.015	.018	.020	.015	.018	.020
MM	.305	.381	.457	.381	.457	.508	.381	.457	.508

MAX CAP @ VOLTAGE

Z5U DIELECTRIC									
Min Cap	391	391	391	561	561	561	561	561	561
5V	124	154	254	274	394	394	564	684	824
16V	124	154	254	274	394	394	564	684	824
25V	683	104	124	224	274	334	474	564	684
50V	473	683	823	154	184	224	334	394	474

Y5V DIELECTRIC									
Min Cap	121	121	121	121	121	121	121	121	121
5V	154	184	274	334	474	474	684	824	105
16V	154	184	274	334	474	474	684	824	105
25V	823	124	154	274	334	394	564	684	824
50V	563	823	104	184	224	274	394	474	564



HOW TO ORDER

0805	Z	104	M	160	N	X	T
SIZE See Chart	DIELECTRIC N = COG B = X7R Z = Z5U Y = Y5V	CAPACITANCE Value in Picofarads Two significant figures, followed by number of zeros: 104 = 100,000pF	TOLERANCE J = +/- 5% K = +/- 10% COG, X7R Only M = +/- 20% Z = +80% - 20% P = +100% - 0%	VOLTAGE-VDCW Two significant figures, followed by number of zeros: 160 = 16V	TERMINATION N = Nickel Barrier V = Non solderable Silver P = Ag-Pd COG, X7R Only	THICKNESS OPTION X = Non standard thickness. Specify in Mils if Non EIA thickness is required.	PACKING OPTION T = Reeled



HIGH TEMPERATURE SMT



NOVACAP manufactures chip capacitors designed to operate to 200°C in both COG and X7R dielectrics, for use in harsh environments, such as oil exploration and engine compartment circuitry. Product is available as surface mount chips in sizes 0805 to 7565, or as leaded encapsulated devices in sizes 1515 to 7565, rated to 500 volts (see additional data sheet). Consult NOVACAP for your specific requirements.



CAPACITANCE SELECTION

3 digit code: two significant digits, followed by number of zeros eg: 183 = 18,000 pF

SIZE	0805	1206	1210	1812	1825	2225	4540	7565
LENGTH L	.080 (2.03)	.125 (3.18)	.125 (3.18)	.180 (4.57)	.180 (4.57)	.220 (5.59)	.450 (11.4)	.750 (19.0)
WIDTH W	.050 (1.27)	.060 (1.52)	.100 (2.54)	.125 (3.18)	.250 (6.35)	.250 (6.35)	.400 (10.2)	.650 (16.5)
T MAX.	.054 (1.37)	.064 (1.63)	.065 (1.65)	.065 (1.65)	.080 (2.03)	.080 (2.03)	.300 (7.62)	.400 (10.2)
MB	.020 (.508)	.020 (.508)	.020 (.508)	.024 (.610)	.024 (.610)	.030 (.760)	.060 (1.52)	.060 (1.52)

200°C - COG DIELECTRIC

Min Cap	0R5	1R0	5R0	220	560	680	221	102
25V	222	682	123	223	473	563	224	474
50V	152	562	123	183	393	473	154	474
100V	821	272	472	822	223	273	124	474
250V	561	182	392	562	183	223	124	274
500V	331	821	182	272	822	103	563	184

200°C - X7R DIELECTRIC

Min Cap	121	221	331	331	471	471	102	103
25V	563	184	334	684	125	155	565	186
50V	473	124	274	474	684	684	395	126
100V	333	823	184	394	394	394	275	106
250V	153	393	823	154	184	224	225	685
500V	332	822	183	393	563	563	824	335

DIMENSIONAL TOLERANCES +/- INCHES (MM)

LENGTH L	.008 (.203)	.008 (.203)	.008 (.203)	.012 (.305)	.012 (.305)	.015 (.380)	.015 (.380)	.015 (.380)
WIDTH W	.008 (.203)	.008 (.203)	.008 (.203)	.008 (.203)	.015 (.380)	.015 (.380)	.015 (.380)	.015 (.380)
MB	.010 (.254)	.010 (.254)	.010 (.254)	.014 (.355)	.014 (.355)	.015 (.380)	.015 (.380)	.015 (.380)

MAX CAP @ VOLTAGE

COG "D" CHARACTERISTICS

OPERATING TEMPERATURE RANGE:	-55°C to 200°C
TEMPERATURE COEFFICIENT UP TO 125°C:	0 +/- 30 ppm/°C
DISSIPATION FACTOR @ 25°C:	.001 (0.1%) max
INSULATION RESISTANCE, 25°C 125°C	> 100GΩ or >1000ΩF > 10GΩ or >100ΩF
DIELECTRIC WITHSTANDING VOLTAGE: * WHICHEVER IS GREATER	< 200V, 250% 201-500V, 150% or 500V* > 500V, 120%, or 750V*
AGING RATE:	0% per decade
TEST PARAMETERS:	1KHz, 1.0 +/- 0.2 VRMS, 25°C 1MHZ for Capacitance <100pF

X7R "E" DIELECTRIC CHARACTERISTICS

OPERATING TEMPERATURE RANGE:	-55°C to 200°C
TEMPERATURE COEFFICIENT UP TO 125°C:	See TC Graph below.
DISSIPATION FACTOR @ 25° C:	25% max @ >25V, 35% max ≤25V
INSULATION RESISTANCE, 25°C 125°C	> 100GΩ or >1000ΩF > 10GΩ or >100ΩF
DIELECTRIC WITHSTANDING VOLTAGE: * WHICHEVER IS GREATER	< 200V, 250% 201-500V, 150% or 500V* > 500V, 120%, or 750V*
AGING RATE:	< 2.0% per decade
TEST PARAMETERS:	1KHz, 1.0 +/- 0.2 VRMS, 25°C

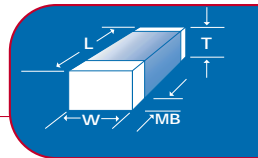
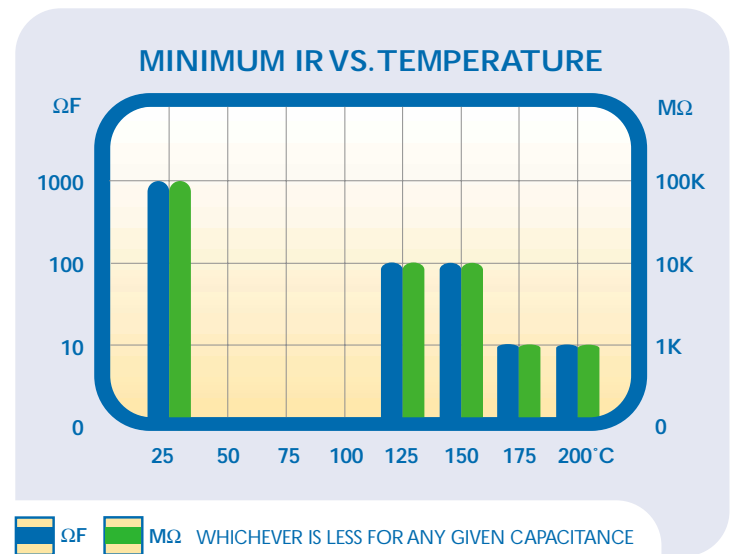
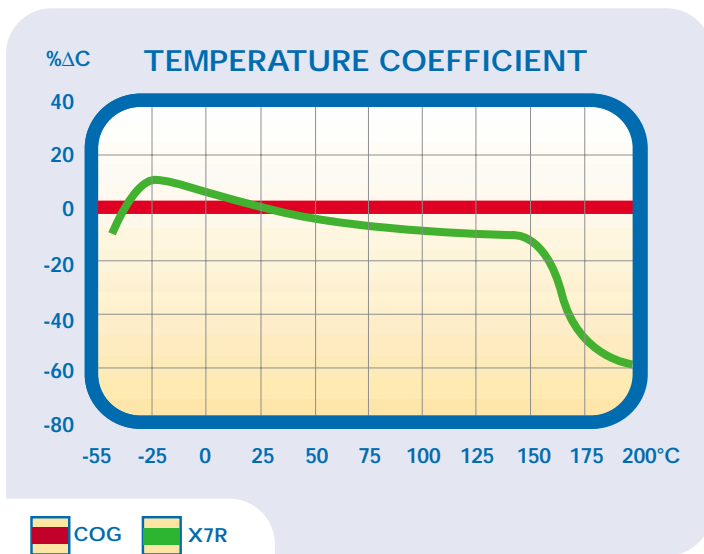

HOW TO ORDER

1210	E	104	M	250	P	X	H	T	M
SIZE See Chart	DIELECTRIC D = 200°C COG E = 200°C X7R	CAPACITANCE Value in Picofarads Two significant figures, followed by number of zeros: 104 = 100,000pF	TOLERANCE F = +/- 1% G = +/- 2% COG only J = +/- 5% K = +/- 10% M = +/- 20%	VOLTAGE-VDCW Two significant figures, followed by number of zeros: 250 = 25V	TERMINATION P= Silver Palladium N= Nickel Barrier, for less than 160°C operation	THICKNESS OPTION X = Non standard thickness. Specify in Mils if Non EIA thickness is required.	HI REL TESTING Ref: MIL-PRF-55681	PACKING OPTION T = Reeled	MARKING OPTION M = Marked (See Marking Specifications)



RING DETECT CAPACITORS



NOVACAP offers a line of low ESR surface mount capacitors ideally suited for "Tip & Ring" applications. These units are designed with 250VDC rating to withstand the 52VDC bias and 150 VRMS signal during ring cadence. Chips are offered in X7R dielectric from 0.39 μ F to 1.00 μ F in sizes 1812, 1825 and 2225. Product is also available in Z5U and Y5V dielectric from 0.47 μ F to 1.30 μ F for other ring detection circuits.



MAX CAPACITANCE @ 250 VDC
 3 digit code: two significant digits, followed by number of zeros
 eg: 394 = 390,000 pF (0.39 μ F)

SIZE	1812	1825	2225
LENGTH L	.180 (4.57)	.180 (4.57)	.220 (5.59)
WIDTH W	.125 (3.18)	.250 (6.35)	.250 (6.35)
T MAX	.095 (2.41)	.095 (2.41)	.095 (2.41)
MB	.024 (.610)	.024 (.610)	.030 (.760)
X7R DIELECTRIC			
MAX CAP @ 250V	474	824	105
Z5U / Y5V DIELECTRIC			
MAX CAP @ 250V	564	105	135
DIMENSIONAL TOLERANCES +/- INCHES (MM)			
LENGTH L	.012 (.305)	.012 (.305)	.015 (.380)
WIDTH W	.008 (.203)	.016 (.406)	.015 (.380)
MB	.014 (.355)	.014 (.355)	.015 (.380)

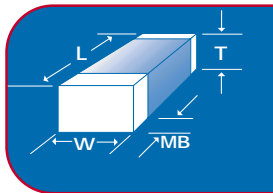

HOW TO ORDER

RD1812	Y	474	M	251	N	X	T	M
SIZE See Chart	DIELECTRIC B = X7R Z = Z5U Y = Y5V	CAPACITANCE Value in Picofarads Two significant figures, followed by number of zeros: 474 = 470,000pF	TOLERANCE J = +/- 5% X7R Only K = +/- 10% M = +/- 20% Z = +80%-20% P = +100%-0%	VOLTAGE-VDCW 251 = 250VDC	TERMINATION N = Nickel Barrier 90/10 Sn/Pb	THICKNESS OPTION X = Non standard thickness. Specify in Mils if Non EIA thickness is required.	PACKING OPTION T = Reeled	MARKING OPTION M = Marked (See Marking Specifications)

CERTIFIED SAFETY CAPACITORS



NOVACAP offers a line of MLC chip capacitors, sizes LS 1808, LS 1812, ES 2211 and ES 2215, X², Y³/Y² Class Compliant* specifically designed for use in modem, facsimile, telephone and other electronic equipment where lightning or overvoltage surges can occur. These parts are rated at 3,000Vdc (Y³) or 5000Vdc (Y²) and 250 Vac safety approved and certified to EN 60950. The product is compliant to Standards EN 132400: 1994/A2: 1998/IEC60384-14, Second Edition: 1993/A1:1995, and meet the requirements of EN61000-4-5, IEC1000-4-5, and IEC801-4-5. Capacitors are available in COG (NP0) dielectric.



SIZE	LS 1808 (Y ³)	LS 1812 (Y ³)	ES 2211 (Y ²)	ES 2215 (Y ²)
LENGTH L	.180 (4.57)	.180 (4.57)	.220 (5.58)	.220 (5.58)
WIDTH W	.080 (2.03)	.125 (3.18)	.110 (2.79)	.150 (3.81)
T MAX	.080 (2.03)	.120 (3.05)	.110 (2.79)	.150 (3.81)
MB	.024 (.609) Typical	.024 (.609) Typical	.030 (.762) Typical	.030 (.762) Typical
CREEPAGE	.102 (2.60) Min	.102 (2.60) Min	.102 (3.00) Min	.102 (3.00) Min
CAP RANGE	5-1000pF	1000-2200pF	5-680pF	1000pF

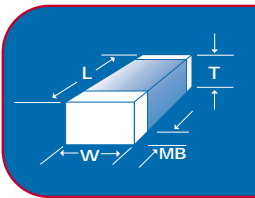

CERTIFICATION NUMBERS

TUV	R9972698.01,.02,.03 (LS 1808), R9972698.05 (LS 1812) & R2072738.01 (ES 2211, ES 2215)
STANDARDS	EN 132400, EN 60950, IEC 60384-14 Second Edition, Class X ² Y ³

Part Identification Marking will be placed on the reel.

HOW TO ORDER

LS1808	N	301	K	302	N	X	T	M
SIZE LS 1808 LS 1812 ES 2211 ES 2225	DIELECTRIC N = COG	CAPACITANCE MAX VALUE IS 1000pF Two significant figures, followed by number of zeros: 331 = 330pF	TOLERANCE J = +/- 5 % K = +/- 10 % M = +/- 20 %	VOLTAGE-VDCW LS 302 = 3000 VDC ES 502 = 5000 VDC	TERMINATION N=Nickel Barrier 90/10 Sn/Pbr	THICKNESS OPTION X= Non standard thickness. Specify in Mils if required.	PACKING OPTION T= Reeled	MARKING OPTION Part marking available upon request

*Compliant with Robustness of Termination (cl 4.3) test according to IEC 60384-1 amendment 3 cl 4.34 and 4.35 Resistance to Soldering Heat (cl 4.4) tested according to IEC 60384-1 amendment 3 cl. 4.14.2, Impulse Test made with 2.5 KV or 5.0KV as required according to 6.4.2.1 in EN 60950. The creepage distance between live parts of different polarity meets the requirements of IEC 60950.



COMMERCIAL RANGES

NOVACAP high voltage products are designed, manufactured and tested 100% for optimum performance. These capacitors offer the highest capacitance available per kilo-volt rating, in COG and X7R characteristics and are appropriate for commercial/industrial applications to 10 KV. The non-polar inner electrode design permits capacitors to be arrayed in stacks with no voltage gradient between units. Chips have rounded surfaces to improve structural integrity and encapsulation in use. Applications include power supply and voltage multiplier circuits. Other sizes and voltage ratings are available, please consult the factory. High reliability versions are offered and have restricted capacitance ranges, please refer to other NOVACAP data sheets.

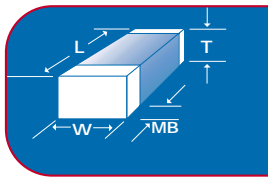

COMMERCIAL RANGES, RATED TO 6 KV

SIZE	1515	1808	1812	1825	2020	2225	2520	3333								
Min Cap	100	100	150	390	390	390	390	390								
LENGTH L	.150 (3.81)	.180 (4.57)	.180 (4.57)	.180 (4.57)	.200 (5.08)	.220 (5.59)	.250 (6.35)	.330 (8.38)								
WIDTH W	.150 (3.81)	.080 (2.03)	.125 (3.18)	.250 (6.35)	.200 (5.08)	.250 (6.35)	.200 (5.08)	.330 (8.38)								
T MAX	.130 (3.30)	.080 (2.03)	.100 (2.54)	.140 (3.56)	.180 (4.57)	.150 (3.81)	.180 (4.57)	.250 (6.35)								
MB	.040 (1.02)	.038 (.965)	.038 (.965)	.038 (.965)	.045 (1.14)	.045 (1.14)	.050 (1.27)	.050 (1.27)								
MAXIMUM CAPACITANCE 3 Digit Code: See How to Order																
	COG	X7R	COG	X7R	COG	X7R	COG	X7R	COG	X7R	COG	X7R	COG	X7R	COG	X7R
500V	682	184	332	823	562	154	183	474	183	474	223	564	273	684	563	105
600V	392	104	272	683	472	124	123	274	103	224	153	394	123	334	333	564
800V	392	823	222	393	472	823	123	224	682	154	123	274	103	224	183	474
1000V	392	563	182	223	392	473	103	184	682	124	123	224	103	184	183	394
2000V	222	822	102	392	222	822	682	273	472	223	103	333	682	333	123	683
3000V	102	332	471	122	102	272	332	103	272	822	472	123	392	123	103	333
4000V	331	152	121	561	271	122	102	472	821	392	681	682	152	562	392	153
5000V	471	102	391	102	681	152	561	222	222	822
6000V	102	562

V O L T A G E

Dimensions are in inches, bracketed dimensions in millimeters. Tolerances are +/- 5% L & W, or .015" (0.38 mm), whichever is greater. MB dimensions are maximum. T Max. for chip sizes 1808, 1812, 1825 and 2225 are greater than standard EIA max. thickness for those sizes.

HIGH VOLTAGE MLC - COMMERCIAL

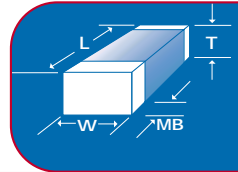
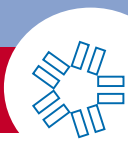

COMMERCIAL RANGES, RATED TO 10 KV



SIZE	3530	4040	4540	5440	5550	6560	7565
Min Cap	390	390	390	390	390	560	101
LENGTH L	.350 (8.89)	.400 (10.2)	.450 (11.4)	.540 (13.7)	.550 (11.4)	.650 (16.5)	.750 (19.0)
WIDTH W	.300 (7.62)	.400 (10.2)	.400 (10.2)	.400 (10.2)	.500 (12.7)	.600 (15.2)	.650 (16.5)
T MAX	.250 (6.35)	.300 (7.62)	.300 (7.62)	.300 (7.62)	.300 (7.62)	.300 (7.62)	.400 (10.2)
MB	.050 (1.27)	.060 (1.52)	.060 (1.52)	.060 (1.52)	.060 (1.52)	.060 (1.52)	.060 (1.52)

MAXIMUM CAPACITANCE

3 Digit Code: See How to Order

	COG	X7R	COG	X7R	COG	X7R	COG	X7R	COG	X7R	COG	X7R	COG	X7R
500V	563	105	393	105	823	185	104	225	124	275	154	395	224	565
1000V	183	394	333	684	393	824	473	824	563	125	104	185	124	225
2000V	123	683	223	154	273	154	333	184	393	274	683	394	823	684
3000V	103	333	183	683	223	823	223	823	333	124	563	184	683	334
4000V	472	183	822	273	103	333	123	393	153	563	223	104	393	154
5000V	272	822	392	183	472	223	562	223	682	393	123	473	183	823
6000V	122	562	152	123	222	123	332	153	392	223	682	333	103	563
7000V	821	332	152	822	182	822	222	103	332	153	562	223	822	393
8000V	821	272	152	562	152	682	182	822	272	123	392	153	562	333
9000V	681	222	122	472	152	562	182	562	222	103	332	123	472	273
10000V	561	182	102	392	122	392	152	472	222	822	332	103	392	223

V
O
L
T
A
G
E

Dimensions are in inches, bracketed dimensions in millimeters. Tolerances are +/- 5% L & W, or .015" (0.38 mm), whichever is greater. MB dimensions are maximum.



HIGH VOLTAGE MLC - COMMERCIAL



COG DIELECTRIC CHARACTERISTICS

OPERATING TEMPERATURE RANGE:	-55°C to 125°C
TEMPERATURE COEFFICIENT:	0 +/- 30 ppm/°C
DISSIPATION FACTOR:	.001 (0.1%) max @ 25°C
INSULATION RESISTANCE, 25°C	>100GΩ or >1000ΩF
125°C	>10GΩ or >100ΩF
DIELECTRIC WITHSTANDING VOLTAGE:	120% VDCW, or 750V*
* WHICHEVER IS GREATER	
AGING RATE:	0% per decade
TEST PARAMETERS:	1KHz, 1.0 +/- 0.2 VRMS, 25°C 1MHZ for Capacitance <100pF

X7R DIELECTRIC CHARACTERISTICS

OPERATING TEMPERATURE RANGE:	-55°C to 125°C
TEMPERATURE COEFFICIENT:	+/-15% ΔC Max.
DISSIPATION FACTOR @ 25° C:	.025 (2.5%) max @ 25°C
INSULATION RESISTANCE, 25°C	>100GΩ or >1000ΩF
125°C	>10GΩ or >100ΩF
DIELECTRIC WITHSTANDING VOLTAGE:	120% VDCW, or 750V*
* WHICHEVER IS GREATER	
AGING RATE:	< 2.0% per decade
TEST PARAMETERS:	1KHz, 1.0 +/- 0.2 VRMS, 25°C

%ΔC **TYPICAL VOLTAGE COEFFICIENT**

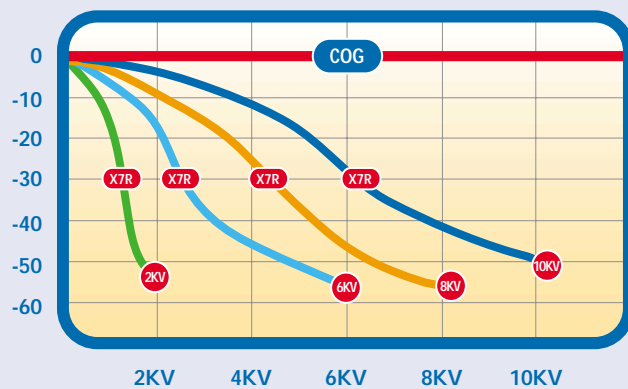

Dielectric withstanding voltage testing requires immersion of the device in a dielectric fluid to preclude arcing over the chip surface, notably at voltages exceeding 1000 VDC. Conformal coating of chips is recommended in use to eliminate arcing.

HOW TO ORDER

4540 B 103 M 302 N X T M

SIZE	DIELECTRIC	CAPACITANCE	TOLERANCE	VOLTAGE-VDCW	TERMINATION	THICKNESS OPTION	PACKING OPTION	MARKING OPTION
See Chart	N = COG B = X7R	Value in Picofarads Two significant figures, followed by number of zeros: 103 = 10,000 pF	J = +/- 5 % K = +/- 10 % M = +/- 20 % Z = +80%-20% P = +100%-0%	Two significant figures, followed by number of zeros: 302= 3000V	N = Nickel Barrier sizes 1515 to 4540 only P = Silver Palladium S = Silver	X = Non standard thickness. Specify in Mils if Non EIA thickness is required.	T = Reeled	M = Marked (See Marking Specifications)

HIGH VOLTAGE MLC - HIGH RELIABILITY



HIGH RELIABILITY RANGES

NOVACAP high voltage capacitors are available specially tested for long term reliability. The non-polar inner electrode design permits capacitors to be arrayed in stacks with no voltage gradient between units. Chips have rounded surfaces to improve structural integrity and encapsulation in use. Units may be tested to MIL-PRF-49467 and MIL-PRF-55681. Applications include aerospace, airborne and military use for radar, power supplies and voltage multiplier circuits. Other sizes and voltage ratings are available, please consult NOVACAP. Commercial versions with higher capacitance efficiency per kilovolt are also available, please refer to other NOVACAP data sheets.

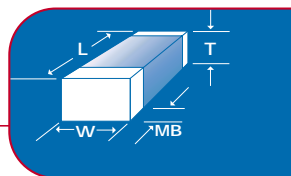

➔ HIGH RELIABILITY RANGES, RATED TO 6 KV



SIZE	1515	1808	1812	1825	2020	2225	2520	3333
Min Cap	100	100	150	390	390	390	390	390
LENGTH L	.150 (3.81)	.180 (4.57)	.180 (4.57)	.180 (4.57)	.200 (5.08)	.220 (5.59)	.250 (6.35)	.330 (8.38)
WIDTH W	.150 (3.81)	.080 (2.03)	.125 (3.18)	.250 (6.35)	.200 (5.08)	.250 (6.35)	.200 (5.08)	.330 (8.38)
T MAX	.130 (3.30)	.080 (2.03)	.100 (2.54)	.140 (3.56)	.180 (4.57)	.150 (3.81)	.180 (4.57)	.250 (6.35)
MB	.040 (1.02)	.038 (.965)	.038 (.965)	.038 (.965)	.045 (1.14)	.045 (1.14)	.050 (1.27)	.050 (1.27)

MAXIMUM CAPACITANCE 3 Digit Code: See How to Order

VOLTAGE	COG		X7R		COG		X7R		COG		X7R		COG		X7R	
	COG	X7R	COG	X7R	COG	X7R	COG	X7R	COG	X7R	COG	X7R	COG	X7R	COG	X7R
500V	472	683	272	333	562	563	123	224	123	124	153	274	183	184	473	474
600V	392	563	222	273	472	473	123	184	822	124	153	224	123	154	273	394
800V	392	473	222	183	472	393	103	124	682	104	123	184	103	154	183	394
1000V	332	333	182	123	392	273	103	823	682	683	123	124	103	104	183	274
2000V	222	392	102	152	222	332	682	123	472	103	103	183	682	153	123	563
3000V	561	122	221	471	471	102	152	392	122	332	102	562	222	822	562	273
4000V	102	222	821	182	681	272	152	392	392	153
5000V	471	102	391	102	561	152	561	222	182	822
6000V	102	562

Dimensions are in inches, bracketed dimensions in millimeters. Tolerances are +/- 5% L & W, or .015" (0.38 mm), whichever is greater. MB dimensions are maximum. T Max. for chip sizes 1808, 1812, 1825 and 2225 are greater than standard EIA max. thickness for those sizes.



HIGH VOLTAGE MLC - HIGH RELIABILITY

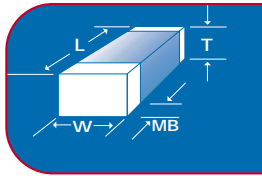

➔ HIGH RELIABILITY RANGES, RATED TO 10KV

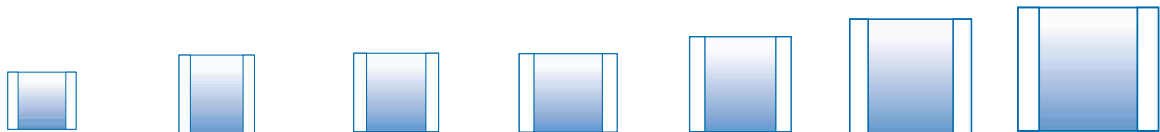

SIZE	3530	4040	4540	5440	5550	6560	7565
Min Cap	390	390	390	390	390	560	101
LENGTH L	.350 (8.89)	.400 (10.2)	.450 (11.4)	.540 (13.7)	.550 (11.4)	.650 (16.5)	.750 (19.0)
WIDTH W	.300 (7.62)	.400 (10.2)	.400 (10.2)	.400 (10.2)	.500 (12.7)	.600 (15.2)	.650 (16.5)
T MAX	.250 (6.35)	.300 (7.62)	.300 (7.62)	.300 (7.62)	.300 (7.62)	.300 (7.62)	.400 (10.2)
MB	.050 (1.27)	.060 (1.52)	.060 (1.52)	.060 (1.52)	.060 (1.52)	.060 (1.52)	.060 (1.52)

MAXIMUM CAPACITANCE 3 Digit Code: See How to Order

	COG	X7R	COG	X7R	COG	X7R	COG	X7R	COG	X7R	COG	X7R	COG	X7R
500V	473	394	393	684	683	824	823	105	124	125	154	185	224	275
1000V	183	274	333	474	393	564	473	684	563	824	104	125	124	185
2000V	123	683	223	104	273	124	333	124	393	184	683	334	823	474
3000V	682	333	123	393	153	563	183	823	223	104	393	184	473	224
4000V	472	183	822	273	103	333	123	393	153	563	223	104	393	154
5000V	222	822	332	183	392	223	472	223	562	393	123	473	153	823
6000V	122	472	182	123	222	123	332	153	392	223	682	333	103	563
7000V	821	332	152	822	182	822	222	103	272	153	562	223	822	393
8000V	•	•	152	562	152	682	182	822	272	123	392	153	562	333
9000V	•	•	•	•	152	562	182	682	222	103	332	123	472	273
10000V	•	•	•	•	122	392	152	472	222	822	272	103	392	223

V O L T A G E

Dimensions are in inches, bracketed dimensions in millimeters. Tolerances are +/- 5% L & W, or .015" (0.38 mm), whichever is greater. MB dimensions are maximum.



COG DIELECTRIC CHARACTERISTICS

OPERATING TEMPERATURE RANGE:	-55°C to 125°C
TEMPERATURE COEFFICIENT:	0 +/- 30 ppm/°C
DISSIPATION FACTOR:	.001 (0.1%) max @ 25°C
INSULATION RESISTANCE, 25°C	>100GΩ or >1000ΩF
125°C	>10GΩ or >100ΩF
DIELECTRIC WITHSTANDING VOLTAGE:	120% VDCW, or 750V*
* WHICHEVER IS GREATER	
AGING RATE:	0% per decade
TEST PARAMETERS:	1KHz, 1.0 +/- 0.2 VRMS, 25°C 1MHZ for Capacitance <100pF

X7R DIELECTRIC CHARACTERISTICS

OPERATING TEMPERATURE RANGE:	-55°C to 125°C
TEMPERATURE COEFFICIENT:	+/-15% ΔC Max.
DISSIPATION FACTOR @ 25° C:	.025 (2.5%) max @ 25°C
INSULATION RESISTANCE, 25°C	>100GΩ or >1000ΩF
125°C	>10GΩ or >100ΩF
DIELECTRIC WITHSTANDING VOLTAGE:	120% VDCW, or 750V*
* WHICHEVER IS GREATER	
AGING RATE:	< 2.0% per decade
TEST PARAMETERS:	1KHz, 1.0 +/- 0.2 VRMS, 25°C

%ΔC **TYPICAL VOLTAGE COEFFICIENT**

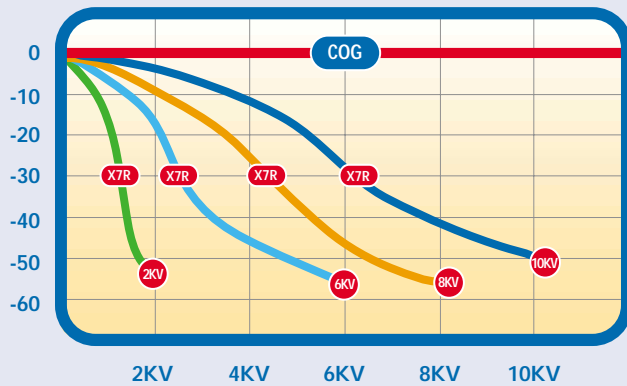

Dielectric withstanding voltage testing requires immersion of the device in a dielectric fluid to preclude arcing over the chip surface, notably at voltages exceeding 1000 VDC. Conformal coating of chips is recommended in use to eliminate arcing.

HOW TO ORDER

4540	B	103	M	302	N	X	H	T	M
SIZE See Chart	DIELECTRIC N = COG B = X7R	CAPACITANCE Value in Picofarads Two significant figures, followed by number of zeros: 103 = 10,000 pF	TOLERANCE J = +/- 5 % K = +/- 10 % M = +/- 20 % Z = +80%-20% P = +100%-0%	VOLTAGE-VDCW Two significant figures, followed by number of zeros: 302 = 3000V	TERMINATION N = Nickel Barrier sizes 1515 to 4540 only P = Silver Palladium S = Silver	THICKNESS OPTION X = Non standard thickness. Specify in Mils if Non EIA thickness is required.	HIGH RELIABILITY TEST Specify Test	PACKING OPTION T = Reeled	MARKING OPTION M = Marked (See Marking Specifications)



SPECIALTY MLC PRODUCTS

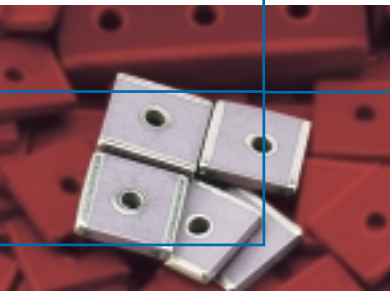

NOVACAP produces a variety of specialty surface mount

MLC sizes, as well as feed thru capacitors, available in COG, X7R, Z5U or Y5V dielectrics. The data sheet shows some of the other chip sizes and specialty product currently fabricated.

NOVACAP will manufacture custom product to customer SCD. Please consult the factory with your particular requirements.

➔ SPECIAL MLC SIZES 25 TO 250 VOLT RATINGS

(Shown in ascending length dimension-inches)

CHIP SIZE	L	W	T MAX
0403	.040	.030	.033
0612	.060	.125	.060
0705	.070	.050	.054
0810	.080	.100	.060
0905	.090	.050	.054
0907	.090	.070	.060
1106	.110	.060	.050
1204	.120	.040	.044
1205	.120	.050	.054
1214	.120	.140	.065
1405	.140	.050	.054
1505	.150	.050	.054
1706	.170	.060	.050
1805	.180	.050	.054
2018	.200	.180	.120
2218	.220	.180	.120
2220	.220	.200	.120
2224	.220	.240	.120
2326	.230	.260	.120
2421	.240	.210	.150
2426	.240	.260	.150
2518	.250	.180	.150
2525	.250	.250	.150
2628	.260	.280	.200
2815	.280	.150	.150
2838	.280	.380	.150

CHIP SIZE	L	W	T MAX
2868	.280	.680	.150
2959	.290	.590	.150
3018	.300	.180	.150
3025	.300	.250	.180
3058	.300	.580	.180
3438	.340	.380	.180
3520	.350	.200	.180
3625	.360	.250	.180
3640	.360	.400	.250
3680	.360	.800	.200
3840	.380	.400	.200
3915	.390	.150	.250
4036	.400	.360	.250
43100	.430	1.00	.250
43200	.430	2.00	.250
4848	.480	.480	.300
4896	.480	.960	.300
4920	.490	.200	.200
4940	.490	.400	.300
55100	.550	1.00	.300
5830	.580	.300	.300
5868	.580	.680	.300
5880	.580	.800	.300
5929	.590	.290	.300
78150	.780	1.50	.300
100100	1.00	1.00	.300
100200	1.00	2.00	.400

LOW ESR - ESL CHIP CAPACITORS

NOVACAP produces chips terminated along the long electrode axis (sizes 0612, 0810 and 1214) to reduce current paths and resistance to charging current flow between electrodes, qualities which lower ESR and ESL for improved performance in high speed de-coupling.

HIGH VOLTAGE

NOVACAP specializes in High Voltage applications. The sizes listed are designed with multiple cascading internal electrodes, to better distribute charge and minimize dielectric stress for enhanced reliability. Contact NOVACAP for solutions to your high voltage needs.

"FEED-THRU" COMPONENTS

NOVACAP manufactures feed thru units used to provide signal conduits through openings while suppressing EMI and RFI interference. Capacitors are constructed with ground plane electrodes completely surrounding the signal feed thru contact, to provide very low ESR and ESL for most effective filtering. Units are supplied as single or multiple devices, with Ag/Pd terminations for easy surface mount attachment to chassis openings. Available in COG, X7R Z5U or Y5V dielectrics, 25 VDC to 1000 VDC rating. Consult NOVACAP for design styles, capacitance ranges, or to specify your requirements.

➔ HIGH VOLTAGE SPECIAL SIZES TO 10 KV (Shown in ascending length dimension-inches)

CHIP SIZE	L	W	T MAX
2211	.220	.110	.180
2319	.230	.190	.180
2321	.230	.210	.180
3010	.300	.100	.200
3015	.300	.150	.200
3030	.300	.300	.200
3327	.330	.270	.250
3424	.340	.240	.250
3545	.350	.450	.250
3560	.350	.600	.250
4020	.400	.200	.300
5040	.500	.400	.300
5128	.510	.280	.300
5248	.520	.480	.300
5440	.540	.400	.300
6040	.600	.400	.300
6060	.600	.600	.300
6666	.660	.660	.300
7030	.700	.300	.300
7060	.700	.600	.300
7065	.700	.650	.300
8040	.800	.400	.400
8080	.800	.800	.400
9040	.900	.400	.400
11050	1.10	.500	.400
13060	1.30	.600	.400



CAPACITOR ARRAYS

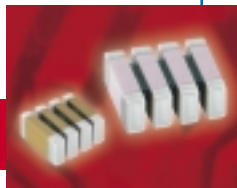

The **Cap-Rack (US Patent 6,058,004)** is an assembly of individual chip capacitors, bonded with high temperature epoxy. This construction permits the assembly of dissimilar capacitance values or dielectrics into one single component, providing extended freedom for board space utilization. The design reduces harmful thermal stress during assembly, behaving as individual components, not as a single large ceramic mass. The Cap-Rack also reduces "cross talk" to insignificant levels by elimination of capacitance coupling between adjacent capacitors. Cap-Racks are available as groupings of chip sizes 0603, 0805, 1005, 1206, 1210, 1808 and 1812, from pairs to as many as eight chips. See separate data sheets for capacitance ranges of the various sizes. Custom sizes, particularly for high voltage applications, are also available. Footprint dimensions can vary to optimize board space usage. The tables provide typical dimensions and footprints for highest capacitance designs. Consult NOVACAP for your specific requirements.



TYPICAL 4 UNIT ARRAYS

ARRAY SIZE	CR0612	CR1218
L (+/- .015)	.060 (1.52)	.120 (3.05)
T MAX.	.036 (.914)	.060 (1.52)
W MAX.	.126 (3.20)	.265 (6.73)
p (+/- .010)	.035 (.890)	.067 (1.70)
MB MAX.	.014 (.356)	.030 (.760)

MAXIMUM CAPACITANCE PER CHIP (3 Digit Code)

V O L T A G E	CR0612			CR1218		
	COG	X7R	Y5V	COG	X7R	Y5V
16V	102	273	184	153	334	185
25V	821	183	124	123	274	155
50V	681	183	823	103	224	125
100V	331	103	333	562	124	334
250V	181	682	562	272	563	683
500V	•	•	•	102	273	•

■ Cap Arrays require drawings to specify length and width of array, and chip used. Contact Novacap to specify your Cap- Rack requirement.

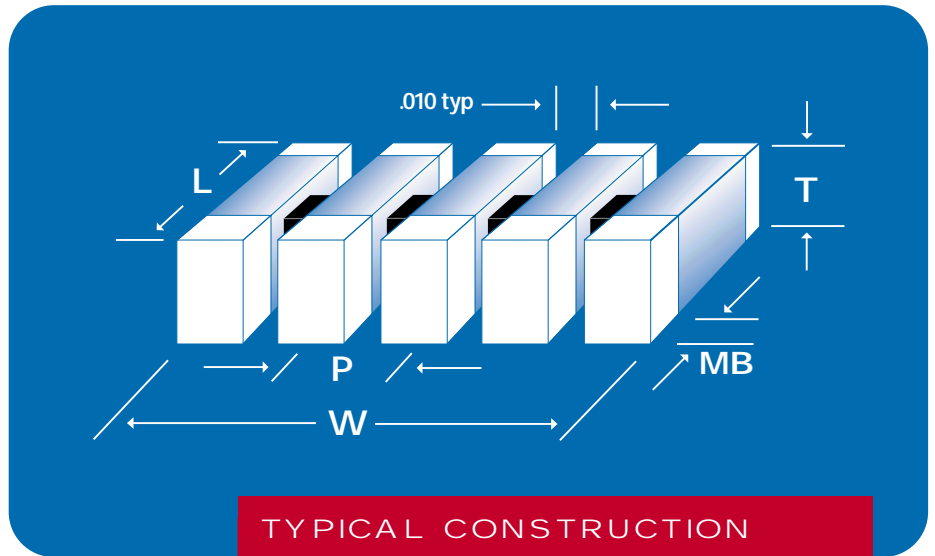

■ Dimensions "P" and "W" may be less than shown when thinner chips are utilized.



➔ HOW TO ORDER

CR	XXYY	N	272	K	101	N	4	H	W
STYLE Cap-Rack	SIZE XX= Length of Array YY = Width 0818 = .080 x .180	DIELECTRIC N = COG B = X7R Y = Y5V	CAPACITANCE Value in Picofarads Two significant figures, followed by number of zeros: 272 = 2700 pF	TOLERANCE B = 0.10 pF C = 0.25 pF D = 0.50 pF F = +/- 1.0 % G = +/- 2.0 % H = +/- 3.0 % J = +/- 5.0 % K = +/- 10 % M = +/- 20 % Z = +80% -20% P = +100% -0%	VOLTAGE-VDCW Two significant figures, followed by number of zeros: 101 = 100V	TERMINATION N = Nickel Barrier P = Ag-Pd	NUMBER OF CHIPS	HI REL OPTION Ref: MIL-PRF-55681	PACKING OPTION T = Reeled



HIGH-TEMP CAPACITORS

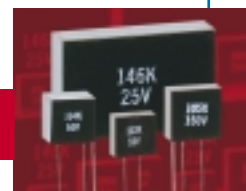
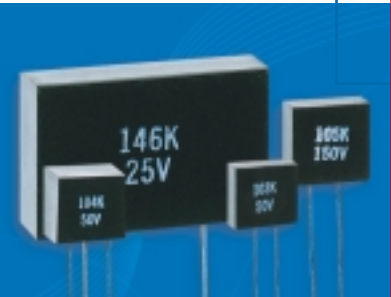

NOVACAP manufactures encapsulated capacitors designed to operate to 200 °C in both COG and X7R dielectrics for use in very harsh environments, where isolation and protection of the device is required for optimum reliability. Product is available as encapsulated devices with 22 AWG tinned copper leads, in sizes 1515 to 7565, rated to 500 volts, marked with capacitance and voltage ratings. Consult NOVACAP for your specific requirements.

▶ CAPACITANCE SELECTION 3 digit code: two significant digits, followed by number of zeros eg: 183 = 18,000 pF

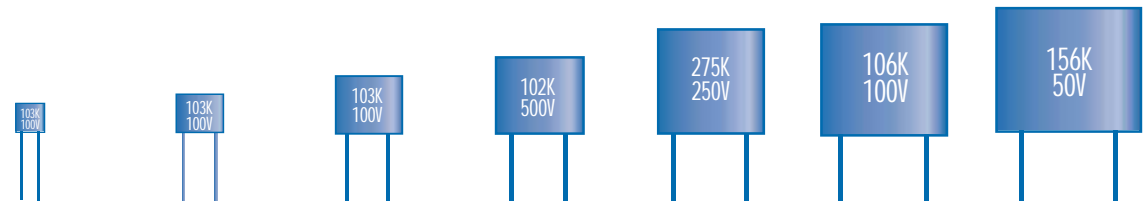

SIZE	1515	2520	3530	4540	5550	6560	7565
W MAX.	.300 (7.62)	.400 (10.2)	.500 (12.7)	.725 (18.4)	.795 (20.2)	.925 (23.5)	1.125 (28.6)
H MAX.	.300 (7.62)	.400 (10.2)	.500 (12.7)	.500 (12.7)	.745 (18.9)	.750 (19.0)	.750 (19.0)
T MAX.	.150 (3.81)	.200 (5.08)	.265 (6.73)	.325 (8.26)	.350 (8.89)	.350 (8.89)	.375 (9.52)
S +/- .030	.170 (4.32)	.280 (7.10)	.380 (9.65)	.480 (12.2)	.580 (14.7)	.680 (17.3)	.780 (19.8)

MAX CAP & VOLTAGE

200 °C - COG DIELECTRIC							
Min Cap	100	390	390	390	390	560	101
25V	333	104	184	274	334	564	684
50V	333	104	184	274	334	474	684
100V	273	823	154	224	224	394	474
250V	153	473	104	154	224	334	474
500V	562	183	473	823	124	184	224

200 °C - X7R DIELECTRIC							
Min Cap	102	102	102	102	122	182	272
25V	824	225	395	685	106	156	186
50V	684	225	395	685	825	126	156
100V	564	185	335	565	685	106	126
250V	154	684	155	275	395	565	825
500V	683	184	394	82	155	225	275

COG "D" CHARACTERISTICS

OPERATING TEMPERATURE RANGE:	-55°C to 200°C
TEMPERATURE COEFFICIENT UP TO 125°C:	0 +/- 30 ppm/°C
DISSIPATION FACTOR @ 25°C:	.001 (0.1%) max
INSULATION RESISTANCE, 25°C 125°C	> 100GΩ or >1000ΩF > 10GΩ or >100ΩF
DIELECTRIC WITHSTANDING VOLTAGE: * WHICHEVER IS GREATER	< 200V, 250% 201-500V, 150% or 500V* > 500V, 120%, or 750V*
AGING RATE:	0% per decade
TEST PARAMETERS:	1KHz, 1.0 +/- 0.2 VRMS, 25°C 1MHZ for Capacitance <100pF

X7R "E" DIELECTRIC CHARACTERISTICS

OPERATING TEMPERATURE RANGE:	-55°C to 200°C
TEMPERATURE COEFFICIENT UP TO 125°C:	+/- 15% ΔC max
DISSIPATION FACTOR @ 25° C:	25% max @ >25V, 35% max ≤25V
INSULATION RESISTANCE, 25°C 125°C	> 100GΩ or >1000ΩF > 10GΩ or >100ΩF
DIELECTRIC WITHSTANDING VOLTAGE: * WHICHEVER IS GREATER	< 200V, 250% 201-500V, 150% or 500V* > 500V, 120%, or 750V*
AGING RATE:	< 2.0% per decade
TEST PARAMETERS:	1KHz, 1.0 +/- 0.2 VRMS, 25°C

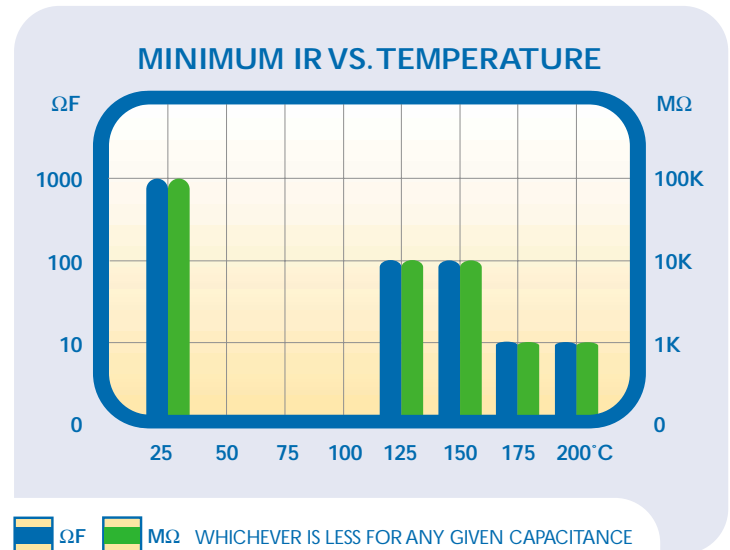
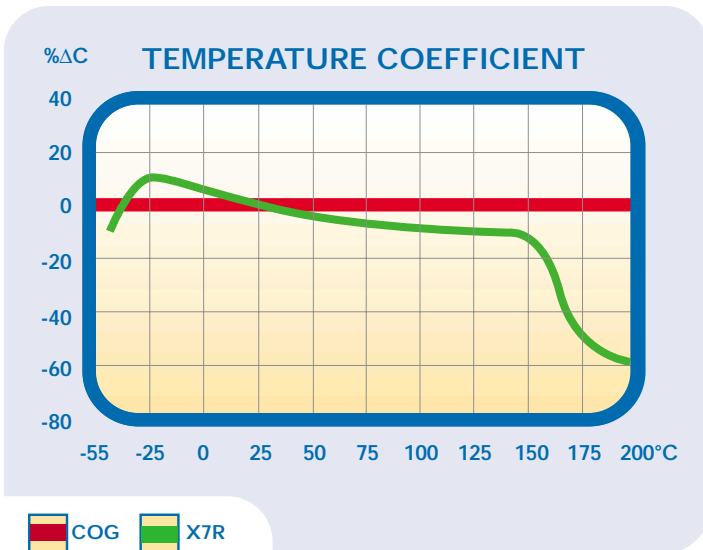

HOW TO ORDER

4540	E	104	M	250	LC	H
SIZE See Chart	DIELECTRIC D = 200°C COG E = 200°C X7R	CAPACITANCE Value in Picofarads Two significant figures, followed by number of zeros: 104 = 100,000pF	TOLERANCE F = +/- 1 % G = +/- 2 % COG only J = +/- 5 % K = +/- 10 % M = +/- 20 %	VOLTAGE-VDCW Two significant figures, followed by number of zeros: 250 = 25V	TERMINALS LC = Encapsulated	HI REL TEST OPTION

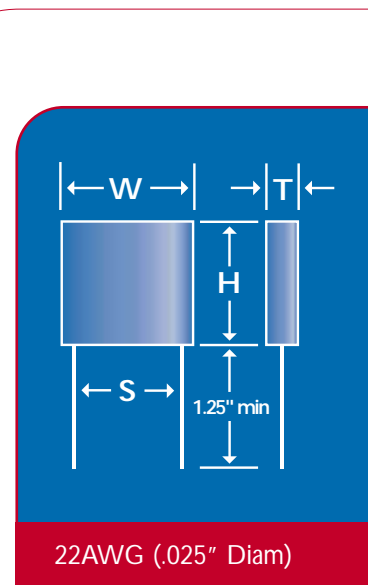



RADIAL LEAD HV CAPACITORS - COMMERCIAL RANGES

COMMERCIAL RANGES

NOVACAP High Voltage Leaded Capacitors are available in **COG** and **X7R** characteristics. Conformal coating and lead mounting provide a rugged configuration for optimum performance, with high capacitance efficiency per KV rating. Units are designed for commercial/industrial use to 10 KV, with application in power supply and voltage multiplier circuits. Minimum voltage is 500Vdc. Higher voltage ratings are available, as well as high reliability versions, with restricted capacitance ranges. Please refer to other NOVACAP literature, or consult the factory.

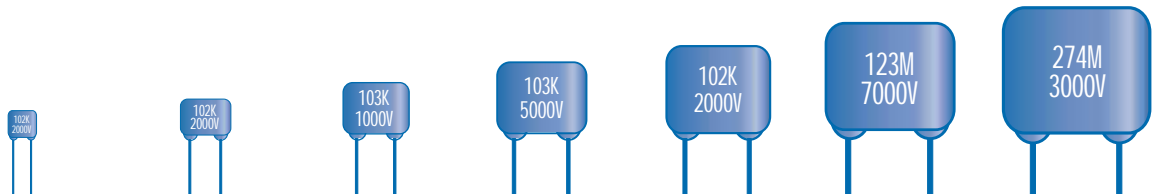
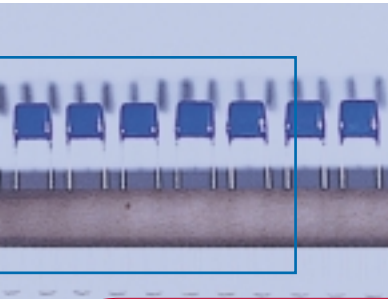

SIZE	1515	2520	3530	4540	5550	6560	7565
W MAX.	.250 (6.35)	.400 (10.2)	.500 (12.7)	.600 (15.2)	.700 (17.8)	.800 (20.3)	.900 (22.8)
H MAX.	.250 (6.35)	.350 (8.89)	.450 (11.4)	.550 (11.4)	.650 (16.5)	.750 (19.0)	.850 (21.6)
T MAX.	.200 (5.08)	.250 (6.35)	.350 (8.89)	.400 (10.2)	.400 (10.2)	.400 (10.2)	.500 (12.7)
S +/- .030	.170 (4.32)	.280 (7.10)	.380 (9.65)	.480 (12.2)	.580 (14.7)	.680 (17.3)	.780 (19.8)

MAXIMUM CAPACITANCE 3 Digit Code: See How to Order

V O L T A G E

	COG	X7R	COG	X7R	COG	X7R	COG	X7R	COG	X7R	COG	X7R	COG	X7R
500V	682	184	223	564	393	824	563	125	104	185	154	275	224	475
600V	392	104	123	274	273	564	473	824	563	155	104	225	154	335
800V	392	823	103	224	183	334	333	684	563	125	823	185	104	225
1000V	392	563	103	184	153	274	223	564	563	105	823	155	104	185
2000V	222	822	682	333	123	473	183	823	393	154	563	224	683	394
3000V	102	332	392	123	822	223	822	393	273	683	393	104	563	184
4000V	331	152	152	562	392	123	272	183	123	273	183	393	333	823
5000V	.	.	561	222	182	562	182	103	472	183	562	273	153	563
6000V	102	332	122	682	332	123	472	183	562	333
7000V	681	222	122	472	222	822	332	123	472	223
8000V	471	152	821	332	182	682	272	822	472	183
9000V	391	102	681	272	152	562	222	682	392	153
10000V	222	122	392	182	562	392	123

Dimensions in inches; bracketed dimensions in millimeters.



COG DIELECTRIC CHARACTERISTICS

OPERATING TEMPERATURE RANGE:	-55°C to 125°C
TEMPERATURE COEFFICIENT:	0 +/- 30 ppm/°C
DISSIPATION FACTOR:	.001 (0.1%) max @ 25°C
INSULATION RESISTANCE, 25°C	>100GΩ or >1000ΩF
125°C	>10GΩ or >100ΩF
DIELECTRIC WITHSTANDING VOLTAGE:	120% VDCW, or 750V*
* WHICHEVER IS GREATER	
AGING RATE:	0% per decade
TEST PARAMETERS:	1KHz, 1.0 +/- 0.2 VRMS, 25°C
	1MHZ for Capacitance <100pF

X7R DIELECTRIC CHARACTERISTICS

OPERATING TEMPERATURE RANGE:	-55°C to 125°C
TEMPERATURE COEFFICIENT:	+/-15% ΔC Max.
DISSIPATION FACTOR @ 25° C:	.025 (2.5%) max @ 25°C
INSULATION RESISTANCE, 25°C	>100GΩ or >1000ΩF
125°C	>10GΩ or >100ΩF
DIELECTRIC WITHSTANDING VOLTAGE:	120% VDCW, or 750V*
* WHICHEVER IS GREATER	
AGING RATE:	< 2.0% per decade
TEST PARAMETERS:	1KHz, 1.0 +/- 0.2 VRMS, 25°C

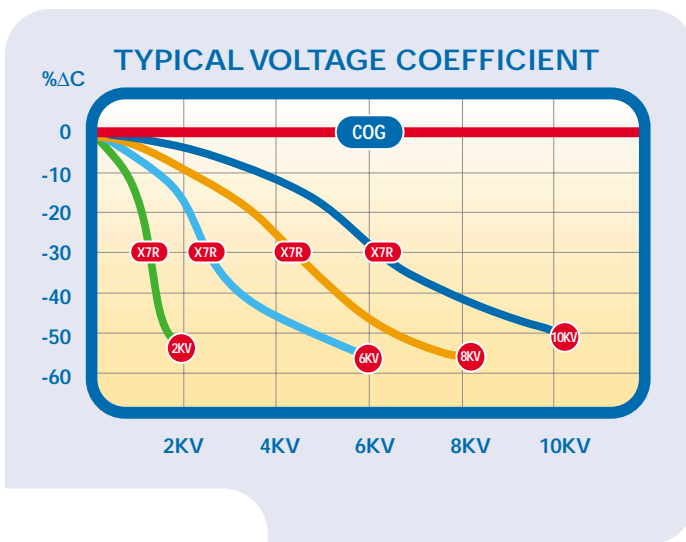

HOW TO ORDER

4540	B	103	K	302	LE
SIZE See Chart	DIELECTRIC N = COG B = X7R	CAPACITANCE Value in Picofarads Two significant figures, followed by number of zeros: 103 = 10,000pF	TOLERANCE J = +/- 5 % K = +/- 10 % M = +/- 20 %	VOLTAGE-VDCW Two significant figures, followed by number of zeros: 302 = 3000V	TERMINALS LE = Radial Lead Conformal Coat LO = Radial Lead Uncoated

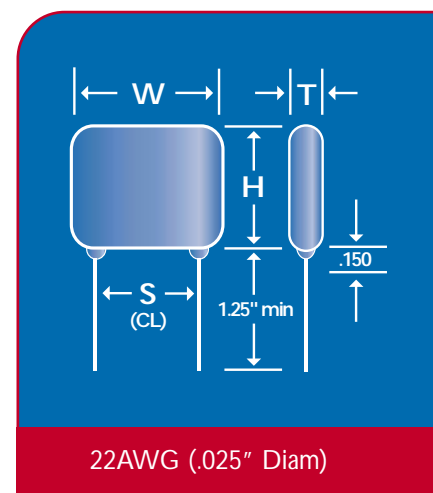



RADIAL LEAD HV CAPACITORS - HIGH RELIABILITY RANGES

HIGH RELIABILITY RANGES



NOVACAP High Voltage Leaded Capacitors with optimum design and special testing for long term reliability are available in COG and X7R characteristics. Conformal coating and lead mounting provide a rugged configuration for optimum performance. Units may be tested to MIL-PRF-49467 and/or MIL-PRF-39014. Applications include aerospace, airborne and military use for

radar, power supplies and voltage multiplier circuits. Higher than cataloged voltage ratings are available. Commercial versions with higher capacitance efficiency per KV are offered, please refer to other NOVACAP literature, or consult the factory.

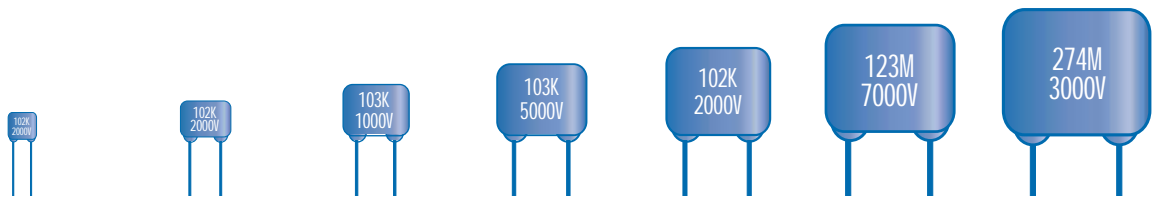

SIZE	1515	2520	3530	4540	5550	6560	7565
W MAX.	.250 (6.35)	.400 (10.2)	.500 (12.7)	.600 (15.2)	.700 (17.8)	.800 (20.3)	.900 (22.8)
H MAX.	.250 (6.35)	.350 (8.89)	.450 (11.4)	.550 (11.4)	.650 (16.5)	.750 (19.0)	.850 (21.6)
T MAX.	.200 (5.08)	.250 (6.35)	.350 (8.89)	.400 (10.2)	.400 (10.2)	.400 (10.2)	.500 (12.7)
S +/- .030	.170 (4.32)	.280 (7.10)	.380 (9.65)	.480 (12.2)	.580 (14.7)	.680 (17.3)	.780 (19.8)

MAXIMUM CAPACITANCE 3 Digit Code: See How to Order

V
O
L
T
A
G
E

	COG	X7R	COG	X7R	COG	X7R	COG	X7R	COG	X7R	COG	X7R	COG	X7R
500V	472	683	153	154	333	334	393	564	563	105	104	155	184	185
600V	392	563	123	124	223	274	393	564	563	105	823	155	124	185
800V	392	473	123	124	153	274	333	564	563	824	823	125	104	185
1000V	332	333	103	104	153	224	333	394	563	684	823	105	104	125
2000V	222	392	682	153	123	473	223	683	393	104	563	154	683	274
3000V	561	122	222	822	562	223	123	333	183	473	333	683	393	124
4000V	.	.	152	392	392	123	822	183	123	273	183	393	333	823
5000V	.	.	561	222	182	562	272	103	392	183	562	273	103	563
6000V	821	332	182	682	332	103	472	183	562	333
7000V	681	222	122	472	222	822	332	123	472	223
8000V	471	152	122	332	182	682	272	822	472	183
9000V	391	102	821	272	152	562	222	682	392	153
10000V	681	222	122	392	182	562	332	123

Dimensions in inches; bracketed dimensions in millimeters.

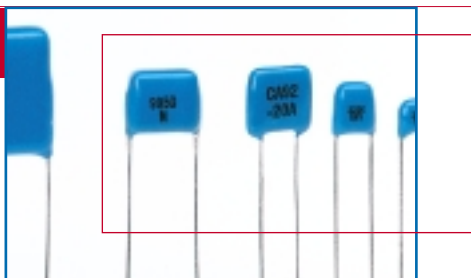

COG DIELECTRIC CHARACTERISTICS

OPERATING TEMPERATURE RANGE:	-55°C to 125°C
TEMPERATURE COEFFICIENT:	0 +/- 30 ppm/°C
DISSIPATION FACTOR:	.001 (0.1%) max @ 25°C
INSULATION RESISTANCE, 25°C	>100GΩ or >1000ΩF
125°C	>10GΩ or >100ΩF
DIELECTRIC WITHSTANDING VOLTAGE:	120% VDCW, or 750V*
* WHICHEVER IS GREATER	
AGING RATE:	0% per decade
TEST PARAMETERS:	1KHz, 1.0 +/- 0.2 VRMS, 25°C
	1MHZ for Capacitance <100pF

X7R DIELECTRIC CHARACTERISTICS

OPERATING TEMPERATURE RANGE:	-55°C to 125°C
TEMPERATURE COEFFICIENT:	+/-15% ΔC Max.
DISSIPATION FACTOR @ 25° C:	.025 (2.5%) max @ 25°C
INSULATION RESISTANCE, 25°C	>100GΩ or >1000ΩF
125°C	>10GΩ or >100ΩF
DIELECTRIC WITHSTANDING VOLTAGE:	120% VDCW, or 750V*
* WHICHEVER IS GREATER	
AGING RATE:	< 2.0% per decade
TEST PARAMETERS:	1KHz, 1.0 +/- 0.2 VRMS, 25°C

TYPICAL VOLTAGE COEFFICIENT

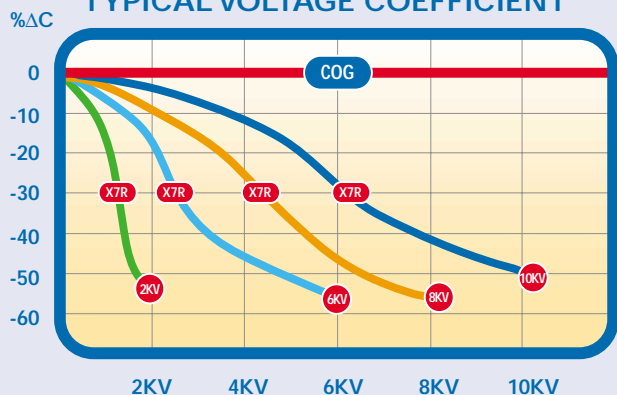

HOW TO ORDER

4540	B	103	K	302	LE	H
SIZE See Chart	DIELECTRIC N = COG B = X7R	CAPACITANCE Value in Picofarads Two significant figures, followed by number of zeros: 103 = 10,000pF	TOLERANCE J = +/- 5 % K = +/- 10 % M = +/- 20 %	VOLTAGE-VDCW Two significant figures, followed by number of zeros: 302 = 3000V	TERMINALS LE = Radial Lead Conformal Coat LO = Radial Lead Uncoated	HIGH RELIABILITY Specify Testing

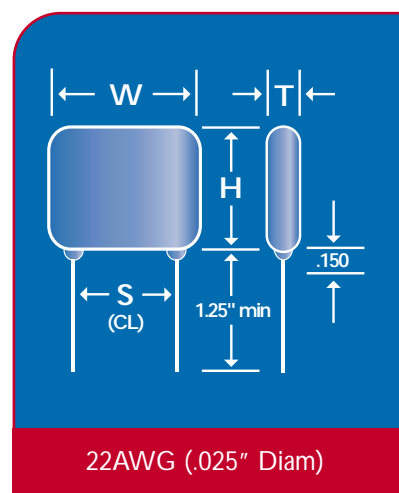



"ST" CAPACITOR ASSEMBLIES



NOVACAP capacitor assemblies with low equivalent series resistance (ESR) and low equivalent series inductance (ESL) are available in dielectric characteristics COG, X7R and Y5V. These assemblies provide the highest capacitance available, based on chip designs for general purpose use. The leaded configurations safeguard the device against thermal and mechanical stresses, and include thru-hole and surface mount J and L style leads, bonded with high temperature solder. High reliability versions for Switch Mode use are described separately, (refer to the "Switch'M" Capacitor Assemblies data sheet). Other sizes and voltage ratings than indicated in the tables are available, consult NOVACAP.



LEAD CONFIGURATION AND ASSEMBLY OPTIONS

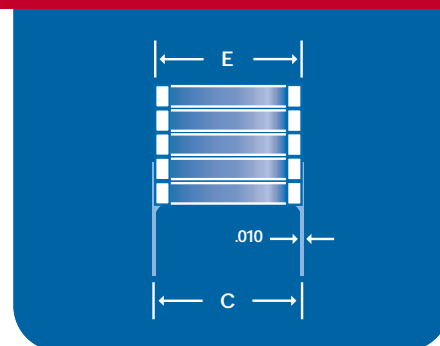
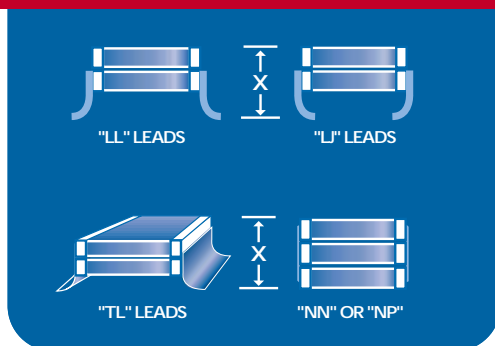
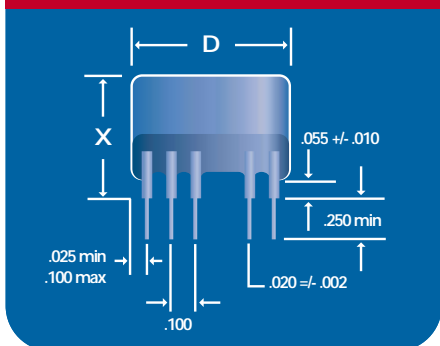

GENERAL PURPOSE "ST" SERIES CAPACITANCE & VOLTAGE SELECTION

DIMENSIONS - INCH (MM)					
SIZE	C +/- .025	D +/- .025	E Max	X Max	Leads /Side
ST 1812	.210 (5.33)	.125 (3.18)	.260 (6.60)	.600 (15.2)	2
ST 1825	.210 (5.33)	.250 (6.35)	.260 (6.60)	.600 (15.2)	3
ST 2225	.250 (6.35)	.250 (6.35)	.300 (7.62)	.715 (18.2)	3
ST 3640	.400 (10.2)	.400 (10.2)	.430 (10.9)	.715 (18.2)	4
ST 4540	.480 (12.2)	.400 (10.2)	.530 (13.5)	.715 (18.2)	4
ST 5550	.580 (14.7)	.500 (12.7)	.630 (16.0)	.715 (18.2)	5
ST 7565	.780 (19.8)	.650 (16.5)	.830 (21.1)	.715 (18.2)	6

MAXIMUM CAPACITANCE (FULL STACK OF 6 CHIPS) 3 Digit Code: See How to Order									
50v	COG			50v	X7R			Y5V	
	100v	200v	500v		100v	200v	500v	50v	100v
184	154	124	393	475	395	225	684	226	106
474	334	274	823	106	825	565	155	476	186
564	474	334	104	106	106	685	225	566	226
125	125	564	224	276	226	186	335	•	•
155	125	684	224	336	276	226	335	•	•
155	125	824	274	396	336	226	565	•	•
335	225	155	564	826	566	476	106	•	•

Dimensions in inches; bracketed dimensions in millimeters.

COG DIELECTRIC CHARACTERISTICS

OPERATING TEMPERATURE RANGE:	-55°C to 125°C
TEMPERATURE COEFFICIENT:	0 +/- 30 ppm/°C
DISSIPATION FACTOR @ 25°C:	.001(0.1%) max
INSULATION RESISTANCE, 25°C	>100GΩ or >1000ΩF
125°C	>10GΩ or >100ΩF
DIELECTRIC WITHSTANDING VOLTAGE:	< 200V or >100ΩF
* WHICHEVER IS GREATER	201-500V, 150% or 500V*
AGING RATE:	0% per decade
TEST PARAMETERS 25°C:	1KHz, 1.0 +/- 0.2 VRMS 1MHZ for Capacitance <100pF

X7R DIELECTRIC CHARACTERISTICS

OPERATING TEMPERATURE RANGE:	-55°C to 125°C
TEMPERATURE COEFFICIENT:	+/-15% ΔC Max.
DISSIPATION FACTOR @ 25°C:	2.5% max @ >25V 3.5% max @ ≤25V
INSULATION RESISTANCE, 25°C	>100GΩ or >1000ΩF
125°C	>10GΩ or >100ΩF
DIELECTRIC WITHSTANDING VOLTAGE:	< 200V, 250%
* WHICHEVER IS GREATER	201-500V, 150% or 500V*
AGING RATE:	< 2.0% per decade
TEST PARAMETERS 25°C:	1KHz, 1.0 +/- 0.2 VRMS

Y5V DIELECTRIC CHARACTERISTICS

OPERATING TEMPERATURE RANGE:	-30°C to 85°C
TEMPERATURE COEFFICIENT:	+22% -82% ΔC Max.
DISSIPATION FACTOR @ 25°C:	5.0% max @ >25V 7.0% max @ ≤25V
INSULATION RESISTANCE, 25°C	>10GΩ or >100ΩF
125°C	N/A
DIELECTRIC WITHSTANDING VOLTAGE:	< 200V, 250%
* WHICHEVER IS GREATER	201-500V, 150% or 500V*
AGING RATE:	< 2.0% per decade
TEST PARAMETERS 25°C:	1KHz, 0.5 +/- 0.2 VRMS

ESR VS. FREQUENCY

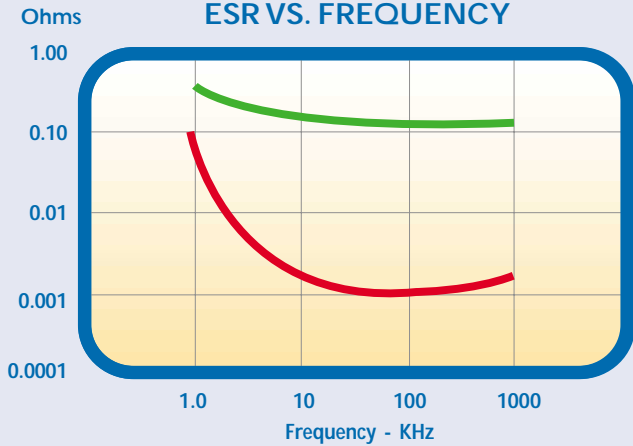

- █ Typical Tantalum
- █ Typical 30µF X7R MLC

IMPEDANCE VS. FREQUENCY

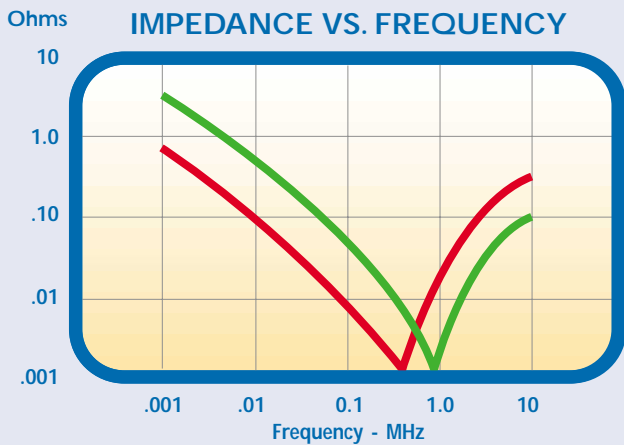

- █ Typical 30µF MLC
- █ Typical 150µF MLC

➔ HOW TO ORDER

ST	3640	B	825	K	101	LJ	X	W	M
STYLE ST = General Purpose	SIZE See Chart	DIELECTRIC N = COG B = X7R Y = Y5V	CAPACITANCE Value in Picofarads Two significant figures, followed by number of zeros: 825 = 8,200,000 pF (8.2m F)	TOLERANCE B = 0.10 pF C = 0.25 pF D = 0.50 pF F = +/- 1.0 % G = +/- 2.0 % H = +/- 3.0 % J = +/- 5.0 % K = +/- 10 % M = +/- 20 % Z = +80% -20% P = +100% -0%	VOLTAGE-VDCW Two significant figures, followed by number of zeros: 101 = 100V	LEAD STYLE LN = Straight LL = L Lead LJ = J Lead TL = L Tab TJ = J Tab NN = Nickel NP = Pd/Ag	OPTION Specify Standoff dimension (X) if less than max.	PACKING OPTION W=Waffle T=Reeled	OPTION M=Marked



"SWITCH'M" CAPACITOR ASSEMBLIES

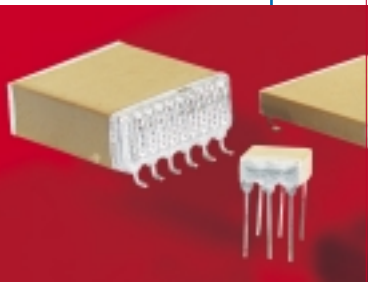

High capacitance assemblies with low equivalent series resistance (ESR) and low equivalent series inductance (ESL) are available for use in high power or high frequency applications, as replacement for tantalums and aluminum electrolytics. Uses include input and output filters in switch mode power supplies, high capacitance discharge circuits, and high temperature filtering/decoupling. The leaded configurations safeguard

the device against thermal and mechanical stresses, and include thru-hole and surface mount J and L style leads, bonded with high temperature solder. Dielectric characteristics offered are COG, X7R and Y5V. The "SM" series are tested per DESC drawing 87106. Other sizes and voltage ratings than indicated in the tables are available, consult NOVACAP.

LEAD CONFIGURATION AND ASSEMBLY OPTIONS

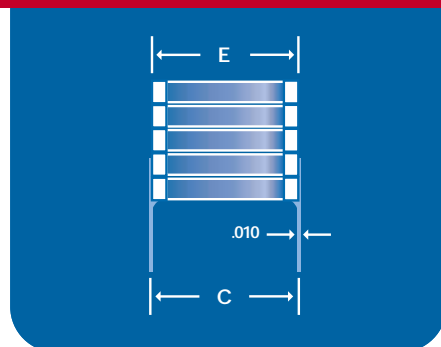
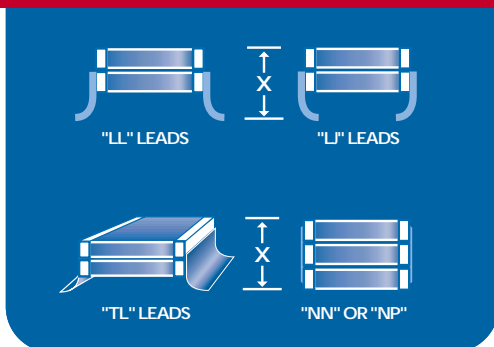
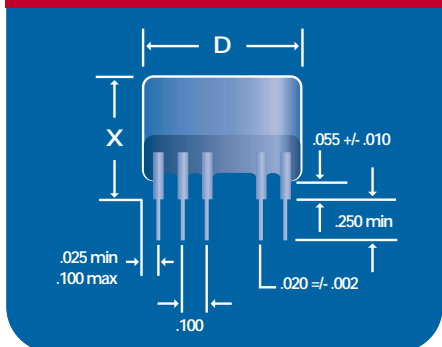

'SWITCH'M SERIES (HI REL TESTED) CAPACITANCE & VOLTAGE SELECTION

DIMENSIONS - INCH (MM)					
SIZE	C +/- .025	D +/- .025	E Max	X Max	Leads /Side
ST 1812	.210 (5.33)	.125 (3.18)	.260 (6.60)	.600 (15.2)	2
ST 1825	.210 (5.33)	.250 (6.35)	.260 (6.60)	.600 (15.2)	3
ST 2225	.250 (6.35)	.250 (6.35)	.300 (7.62)	.715 (18.2)	3
ST 3640	.400 (10.2)	.400 (10.2)	.430 (10.9)	.715 (18.2)	4
ST 4540	.480 (12.2)	.400 (10.2)	.530 (13.5)	.715 (18.2)	4
ST 5550	.580 (14.7)	.500 (12.7)	.630 (16.0)	.715 (18.2)	5
ST 7565	.780 (19.8)	.650 (16.5)	.830 (21.1)	.715 (18.2)	6

MAXIMUM CAPACITANCE (FULL STACK OF 6 CHIPS) 3 Digit Code: See How to Order									
50v	COG			X7R			Y5V		
	100v	200v	500v	50v	100v	200v	500v	50v	100v
184	124	104	273	395	335	185	394	226	106
474	334	224	563	106	685	395	824	396	156
564	394	334	683	106	825	475	105	566	226
125	105	564	154	276	226	126	684	•	•
155	125	684	184	336	276	126	824	•	•
155	125	684	224	396	276	156	475	•	•
335	225	125	474	826	476	276	106	•	•

Dimensions in inches; bracketed dimensions in millimeters.

COG DIELECTRIC CHARACTERISTICS

OPERATING TEMPERATURE RANGE:	-55°C to 125°C
TEMPERATURE COEFFICIENT:	0 +/- 30 ppm/°C
DISSIPATION FACTOR @ 25°C:	.001(0.1%) max
INSULATION RESISTANCE, 25°C	>100GΩ or >1000ΩF
125°C	>10GΩ or >100ΩF
DIELECTRIC WITHSTANDING VOLTAGE:	< 200V, 250V
* WHICHEVER IS GREATER	201-500V, 150% or 500V*
AGING RATE:	0% per decade
TEST PARAMETERS 25°C:	1KHz, 1.0 +/- 0.2 VRMS, 25°C
	1MHZ for Capacitance <100pF

X7R DIELECTRIC CHARACTERISTICS

OPERATING TEMPERATURE RANGE:	-55°C to 125°C
TEMPERATURE COEFFICIENT:	+/-15% ΔC Max.
DISSIPATION FACTOR @ 25°C:	2.5% max @ >25V
	3.5% max @ ≤25V
INSULATION RESISTANCE, 25°C	>100GΩ or >1000ΩF
125°C	>10GΩ or >100ΩF
DIELECTRIC WITHSTANDING VOLTAGE:	< 200V, 250V
* WHICHEVER IS GREATER	201-500V, 150% or 500V*
AGING RATE:	< 2.0% per decade
TEST PARAMETERS 25°C:	1KHz, 1.0 +/- 0.2 VRMS

Y5V DIELECTRIC CHARACTERISTICS

OPERATING TEMPERATURE RANGE:	-30°C to 85°C
TEMPERATURE COEFFICIENT:	+22% -82% ΔC Max.
DISSIPATION FACTOR @ 25°C:	5.0% max @ >25V
	7.0% max @ ≤25V
INSULATION RESISTANCE, 25°C	>10GΩ or >100ΩF
125°C	N/A
DIELECTRIC WITHSTANDING VOLTAGE:	< 200V, 250V
* WHICHEVER IS GREATER	201-500V, 150% or 500V*
AGING RATE:	< 2.0% per decade
TEST PARAMETERS 25°C:	1KHz, 0.5 +/- 0.2 VRMS

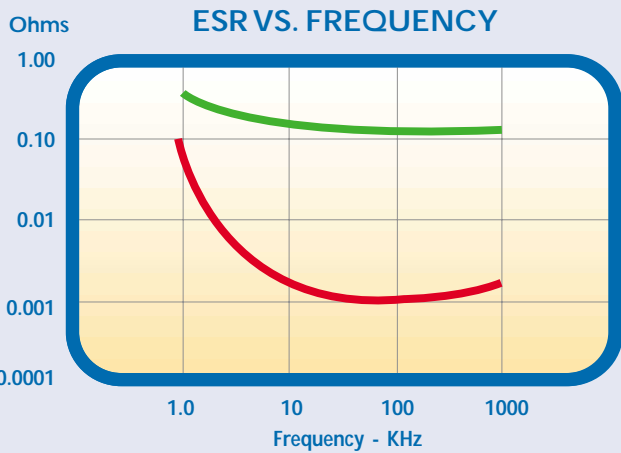

█ Typical Tantalum
█ Typical 30µF X7R MLC

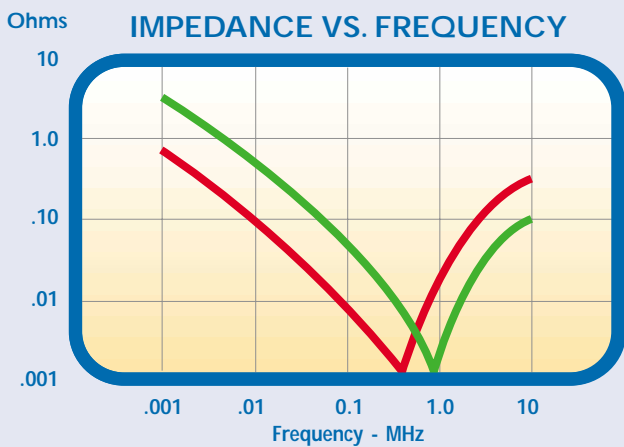

█ Typical 30µF MLC
█ Typical 150µF MLC

➔ HOW TO ORDER

SM	4540	B	106	M	201	LJ	X	W	M
STYLE SM= Switch Mode	SIZE See Chart	DIELECTRIC N = COG B = X7R Y = Y5V	CAPACITANCE Value in Picofarads Two significant figures, followed by number of zeros: 106 = 10,000,000 pF (10.0 mF)	TOLERANCE B = 0.10 pF C = 0.25 pF D = 0.50 pF F = +/- 1.0 % G = +/- 2.0 % H = +/- 3.0 % J = +/- 5.0 % K = +/- 10 % M = +/- 20 % Z = +80% -20% P = +100% -0%	VOLTAGE-VDCW Two significant figures, followed by number of zeros: 201 = 200V	LEAD STYLE LN = Straight LL = L Lead LJ = J Lead TL = L Tab TJ = J Tab NN = Nickel NP = Pd/Ag	OPTION Specify Standoff dimension (X) if less than max.	PACKING OPTION W=Waffle T=Reeled	OPTION M=Marked



CHIP MARKING SYSTEM



NOVACAP chip identification marking is accomplished using an excimer laser which does not degrade the ceramic surface or induce microcracks. The marking code is based on EIA 198 two digit code which determines capacitance value. Laser marking is available for chip sizes 0805 through 2628. Other sizes require special request to determine if applicable. Ink marking is available for chips larger than 2628, or for leaded encapsulated devices. Marking is an option, specify using the letter M in the part number code, as shown below.

MARKING CODE

Value in picofarads for alpha-numeric code

	0	1	2	3	4	5	6	7
L E T T E R								
A	1.0	10	100	1,000	10,000	100,000	1,000,000	10,000,000
B	1.1	11	110	1,100	11,000	110,000	1,100,000	11,000,000
C	1.2	12	120	1,200	12,000	120,000	1,200,000	12,000,000
D	1.3	13	130	1,300	13,000	130,000	1,300,000	13,000,000
E	1.5	15	150	1,500	15,000	150,000	1,500,000	15,000,000
F	1.6	16	160	1,600	16,000	160,000	1,600,000	16,000,000
G	1.8	18	180	1,800	18,000	180,000	1,800,000	18,000,000
H	2.0	20	200	2,000	20,000	200,000	2,000,000	20,000,000
J	2.2	22	220	2,200	22,000	220,000	2,200,000	22,000,000
K	2.4	24	240	2,400	24,000	240,000	2,400,000	24,000,000
L	2.7	27	270	2,700	27,000	270,000	2,700,000	27,000,000
M	3.0	30	300	3,000	30,000	300,000	3,000,000	30,000,000
N	3.3	33	330	3,300	33,000	330,000	3,300,000	33,000,000
P	3.6	36	360	3,600	36,000	360,000	3,600,000	36,000,000
Q	3.9	39	390	3,900	39,000	390,000	3,900,000	39,000,000
R	4.3	43	430	4,300	43,000	430,000	4,300,000	43,000,000
S	4.7	47	470	4,700	47,000	470,000	4,700,000	47,000,000
T	5.1	51	510	5,100	51,000	510,000	5,100,000	51,000,000
U	5.6	56	560	5,600	56,000	560,000	5,600,000	56,000,000
V	6.2	62	620	6,200	62,000	620,000	6,200,000	62,000,000
W	6.8	68	680	6,800	68,000	680,000	6,800,000	68,000,000
X	7.5	75	750	7,500	75,000	750,000	7,500,000	75,000,000
Y	8.2	82	820	8,200	82,000	820,000	8,200,000	82,000,000
Z	9.1	91	910	9,100	91,000	910,000	9,100,000	91,000,000
a	2.5	25	250	2,500	25,000	250,000	2,500,000	25,000,000
b	3.5	35	350	3,500	35,000	350,000	3,500,000	35,000,000
d	4.0	40	400	4,000	40,000	400,000	4,000,000	40,000,000
e	4.5	45	450	4,500	45,000	450,000	4,500,000	45,000,000
f	5.0	50	500	5,000	50,000	500,000	5,000,000	50,000,000
m	6.0	60	600	6,000	60,000	600,000	6,000,000	60,000,000
n	7.0	70	700	7,000	70,000	700,000	7,000,000	70,000,000
t	8.0	80	800	8,000	80,000	800,000	8,000,000	80,000,000
y	9.0	90	900	9,000	90,000	900,000	9,000,000	90,000,000

*9" in the marking code denotes 0.1 multiplier for values under 1.0 pF. eg. "f9"=0.5pF



Two position alpha numeric marking is available on chip sizes 0805 through 2628. The marking denotes retma value and significant figures of capacitance (see table) eg:A5 = 100,000 pF



Three position alpha numeric marking is available on chip sizes 1206 and larger, denoting NOVACAP as vendor (N), followed by the standard two digit alpha numeric identification.

HOW TO ORDER

1210	B	104	M	250	N	X	T	M
SIZE	DIELECTRIC	CAPACITANCE	TOLERANCE	VOLTAGE	TERMINATION	THICKNESS OPTION	PACKING OPTION	MARKING OPTION

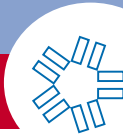

TAPE & REEL SYSTEM

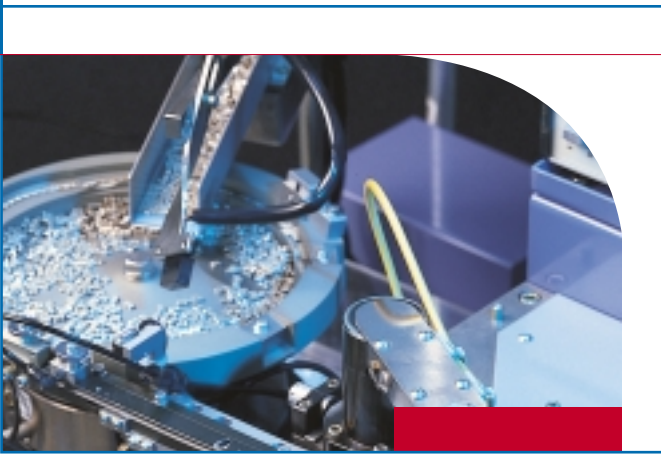

NOVACAP chip capacitors are available packaged in

8mm to 24mm embossed carrier, per EIA RS 481. Specify the

reeled option (T) in the NOVACAP part number code.

Chips are also supplied in bulk or waffle pack.

UNITS PER REEL (TYPICAL)

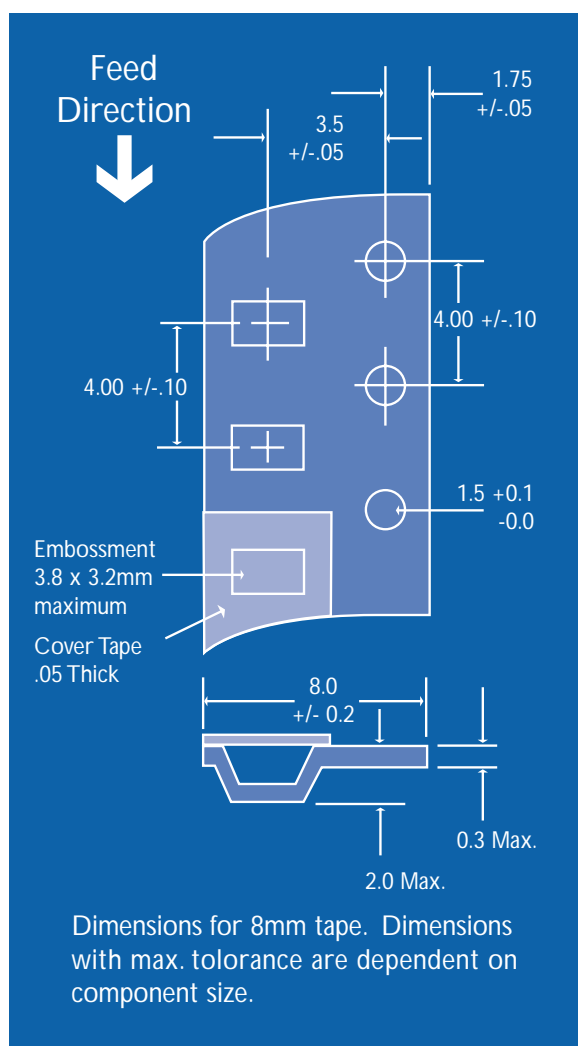

CHIP SIZE	TAPE WIDTH	UNITS PER REEL*	
		7" Diam.	13" Diam.
0402	8 mm	3000-4000	15000
0504	8 mm	3000-4000	15000
0603	8 mm	3000-4000	15000
0805	8 mm	3000-4000	15000
1005	8 mm	2000-4000	15000
1206	8 mm	2000-4000	15000
1210	8 mm	2000-3000	10000
1505	12 mm	2000-3000	10000
1808	12 mm	2000-3000	10000
1812	12 mm	1000	10000
1825	12 mm	1000	5000
2221	12 mm	1000	5000
2225	12 mm	1000	5000
2628	16 mm	•	1000
3333	16 mm	•	1000
3530	16 mm	•	1000
4040	16 mm	•	1000

Quantity per reel varies with chip thickness. Thicker chips (typically higher capacitance values) will result in lesser quantities.

HOW TO ORDER

1210	B	104	M	250	N	X	T	M
SIZE	DIELECTRIC	CAPACITANCE	TOLERANCE	VOLTAGE	TERMINATION	THICKNESS OPTION	PACKING OPTION	MARKING OPTION



NOVACAP FACILITIES

CORPORATE HEADQUARTERS ■ 25136 ANZA DRIVE VALENCIA, CALIFORNIA



25018 AVENUE KEARNY
VALENCIA, CALIFORNIA



25111 ANZA DRIVE
VALENCIA, CALIFORNIA





NOVACAP A  **DOVER** COMPANY

25136 ANZA DRIVE VALENCIA, CA 91355

OFFICE 661•295•5920

FAX 661•295•5928

WEBSITE www.novacap.com

E•MAIL info@novacap.com