

STA801M/802M

2-Output Separate Excitation Switching Type

■Features

- 2 regulators combined 1 package
- Compact inline package
- Output current (0.5A × 2 output)
- Output voltage of Ch2 selectable from 4 levels.
- Built-in flywheel diode (Schottky barrier diode)
- Requires only 7 external components (2 outputs)
- Phase correction and output voltage adjustment performed internally
- Built-in reference oscillator (125kHz) - Compact choke coil can be used due to high frequency (compared to existing Sanken product)
- Built-in overcurrent and thermal protection circuits
- Built-in soft start circuit (Output ON/OFF control)

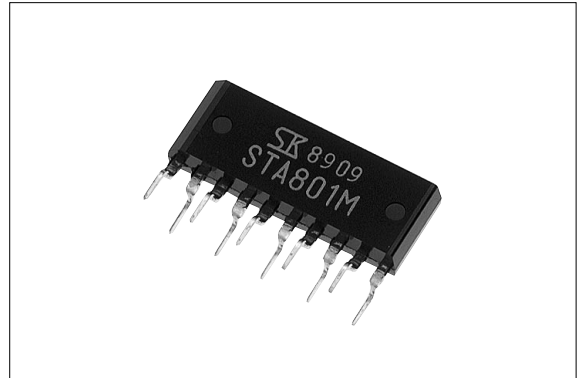

■Applications

- For BS and CS antenna power supplies
- For stabilization of the secondary stage of switching power supplies
- Electronic equipment

■Lineup

Part Number	Output Voltage (V)	
	Ch1	Ch2(Select one output)
STA801M	5	9.0 / 11.5 / 12.1 / 15.5
STA802M	9	9.1 / 11.7 / 12.1 / 15.7

■Absolute Maximum Ratings

Parameter	Symbol	Ratings	Unit
DC Input Voltage	V _{IN}	43	V
Power Dissipation	P _{D1}	6.7(With infinite heatsink)	W
	P _{D2}	1.6(Without heatsink, stand-alone operation)	W
Junction Temperature	T _j	+125	°C
Storage Temperature	T _{stg}	-40 to +125	°C

■Recommended Operating Conditions

Parameter	Symbol	Ratings		Unit
		min.	max.	
DC Input Voltage Range	V _{IN}	Ch2 V _{Omax.} +2	40	V
Output Current Range per Channel	I _O	0	0.5	A
Operating Temperature Range	T _{top}	-20	+125	°C

■Electrical Characteristics

(Ta=25°C)

	Parameter	Symbol	Ratings						Unit
			STA801M			STA802M			
			min.	typ.	max.	min.	typ.	max.	
Ch1	Output voltage 1	Vo1	4.80	5.00	5.20	8.64	9.00	9.36	V
		Conditions	VIN=20V, Io=0.3A			VIN=20V, Io=0.3A			
	Efficiency *	η1		80			86		%
		Conditions	VIN=20V, Io=0.3A			VIN=20V, Io=0.3A			
	Temperature Coefficient of Output Voltage	ΔVo/ΔTa1		±0.5			±1.0		mV/°C
	Line Regulation	ΔVLINE1		30	90		35	110	mV
	Conditions	VIN=10 to 30V, Io=0.3A			VIN=14 to 30V, Io=0.3A				
Load Regulation	ΔVLOAD1		10	40		20	80	mV	
	Conditions	VIN=20V, Io=0.1 to 0.4A			VIN=20V, Io=0.1 to 0.4A				
Ch2 (Select one output)	Output voltage 2-1	Vo2-1	8.64	9.00	9.36	8.74	9.10	9.46	V
		Conditions	VIN=20V, Io=0.3A			VIN=20V, Io=0.3A			
	Output voltage 2-2	Vo2-2	11.04	11.50	11.96	11.24	11.70	12.16	V
		Conditions	VIN=20V, Io=0.3A			VIN=20V, Io=0.3A			
	Output voltage 2-3	Vo2-3	11.62	12.10	12.58	11.62	12.10	12.58	V
		Conditions	VIN=20V, Io=0.3A			VIN=20V, Io=0.3A			
	Output voltage 2-4	Vo2-4	14.88	15.50	16.12	15.08	15.70	16.32	V
		Conditions	VIN=20V, Io=0.3A			VIN=20V, Io=0.3A			
	Vo2-4 Efficiency*	η		89			89		%
		Conditions	VIN=20V, Io=0.3A			VIN=20V, Io=0.3A			
	Temperature Coefficient of Output Voltage	ΔVo/ΔTa		±2.0			±2.0		mV/°C
	Line Regulation	ΔVLINE		40	130		40	130	mV
		Conditions	VIN=20 to 30V, Io=0.3A			VIN=20 to 30V, Io=0.3A			
	Load Regulation	ΔVLOAD		30	120		30	120	mV
	Conditions	VIN=20V, Io=0.1 to 0.4A			VIN=20V, Io=0.1 to 0.4A				
Common	No-load Circuit Current	Icc		15			15		mA
	Switching Frequency	f		125			125		kHz
	Overcurrent Protection Starting Current	Is1	0.51	0.7		0.51	0.7		A

*Efficiency indicates the value when only one channel is active. The value can be calculated as shown below. 7.5mA is deducted for the no-load circuit current of $\frac{I_{cc}}{2}$ at unused output.

$$\eta = \frac{V_o \cdot I_o}{V_{IN} \cdot (I_{IN} - 0.0075)} \times 100(\%)$$

■Standard External Circuit

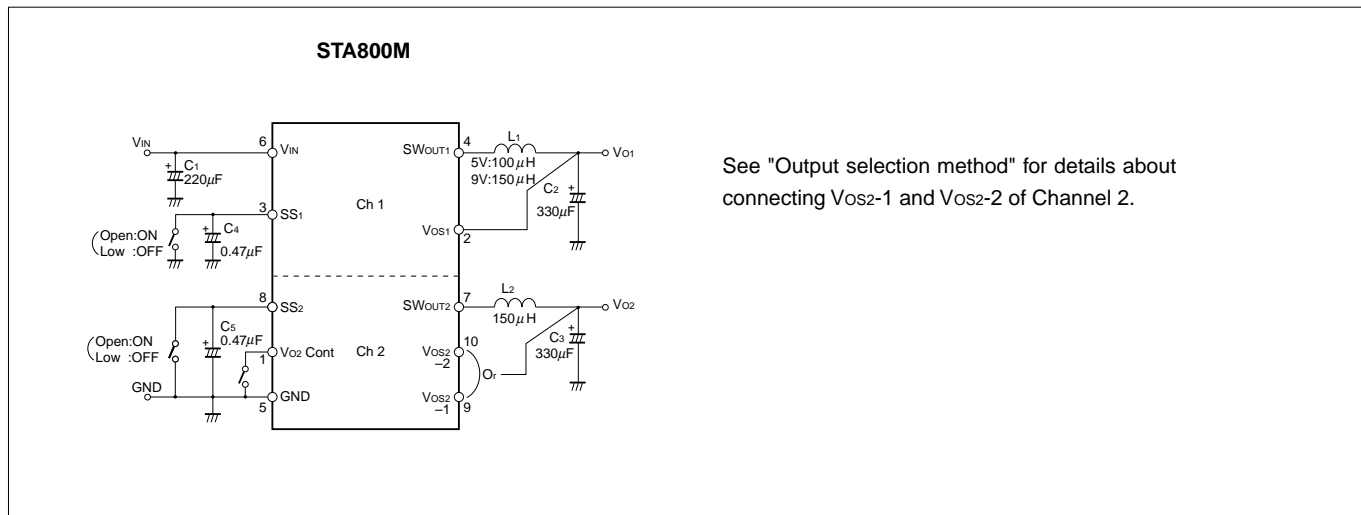

■Ta-Pd Characteristics

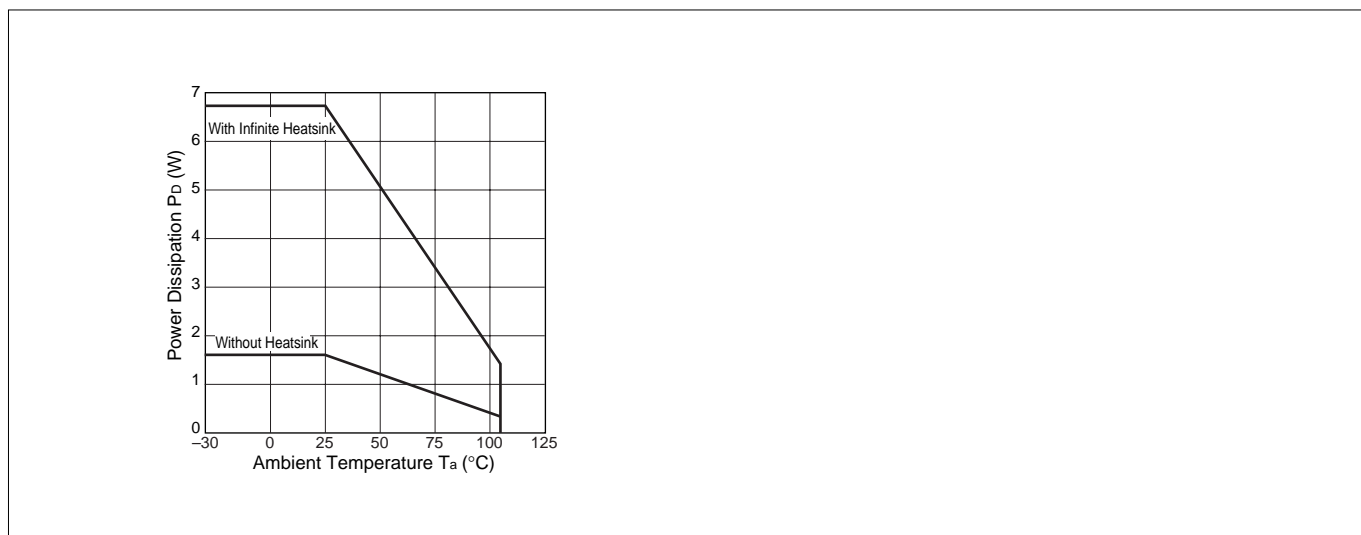

■Selecting External Components

1. Inductors L1 and L2

(1) Suitable for switching regulators

Do not use a coil as a noise filter because it generates excess heat.

(2) Appropriate inductance

A low inductance may cause abnormal oscillation, or cause the overcurrent protection circuit to malfunction in the rated current range.

(3) Satisfying the rated current

Exceeding the rated current may generate an extremely high current to flow due to magnetic saturation.

2. Capacitors C1, C2, and C3

(1) Satisfy the breakdown voltage and allowable ripple current

Exceeding the ratings of these capacitors or using them without derating may shorten their service lives and also cause abnormal oscillation.

(2) Low impedance (C2, and C3)

A low-impedance model is recommended for C2 and C3 to reduce the ripple voltage and stabilize switching. For stable operation throughout the input voltage range, however, the DC equivalent series resistance (ESR) of C2 and C3 should be 0.1 ohm or less.

3. Capacitors C4 and C5

(1) C4 and C5 are soft-start capacitors.

■Selecting Ch2 Output Voltage

When the V_{O2Cont} terminal voltage is set to 0.5V or less, the output voltage changes to the values shown below. To switch the potential at the V_{O2Cont} terminal, drive the open collector of the transistor. No external voltage can be applied to the terminal. Leave the terminal open when not in use because the terminal is already pulled up in the IC. When using terminal no. 9, short it to terminal no. 10.

() : STA802M

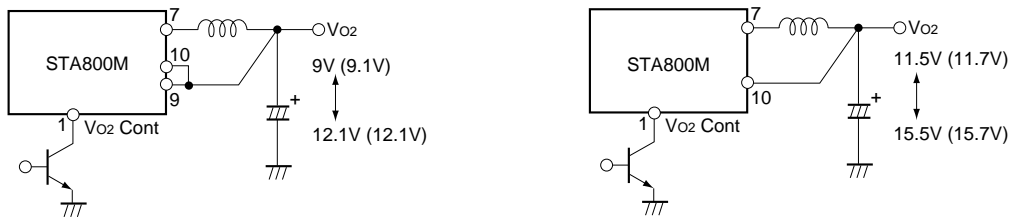

V_{O2} output voltage

V_{O2Cont} terminal (1 pin) / V_{O2} sensing terminal	STA801M		STA802M	
	OPEN	Low	OPEN	Low
9pin	9V	12.1V	9.1V	12.1V
10pin	11.5V	15.5V	11.7V	15.7V

Low : 0.5V or less

■Soft Start ON/OFF Circuit

Terminal nos. 3 and 8 are soft start terminals. Connect a capacitor to the terminal to permit a soft start. Output can be turned on and off by using the soft start terminals. Set the soft start terminal voltage to V_{SSL} (0.15V) or less to stop the output. To switch the potential at the soft start terminals, drive the open collector of the transistor. Since the discharge currents from C4 and C5 flow to the ON/OFF control transistor, limit the current for protection. The SS terminal is pulled up to the power supply in the IC and no external voltage can be applied to the terminal.

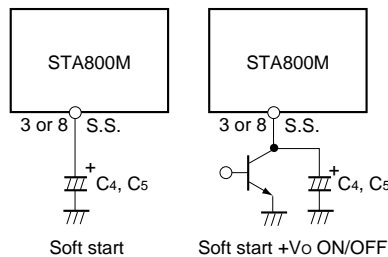

■ Typical Characteristics

($T_a=25^\circ\text{C}$)

STA801M

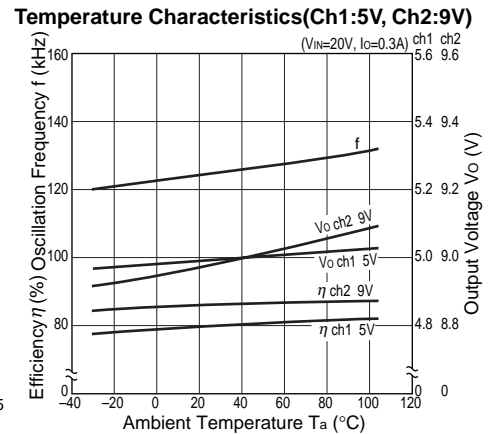
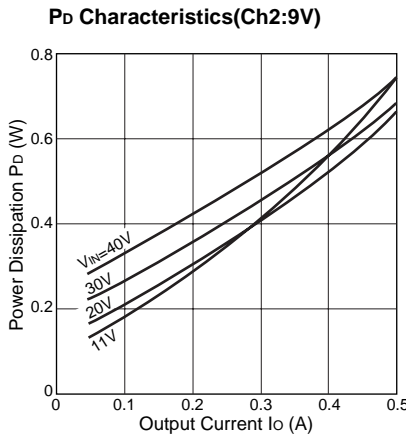
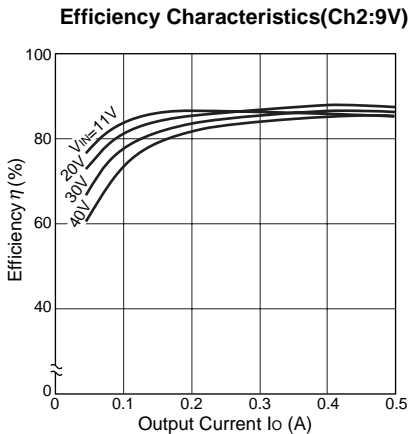
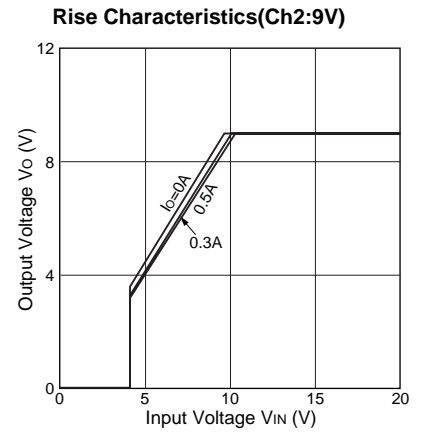
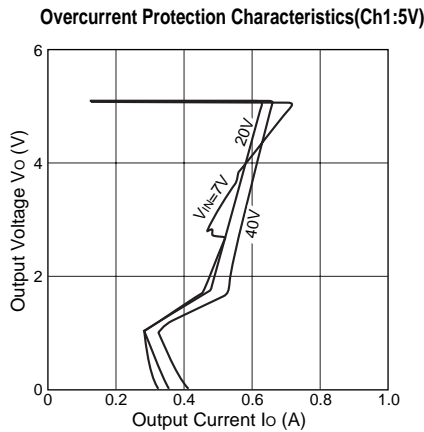
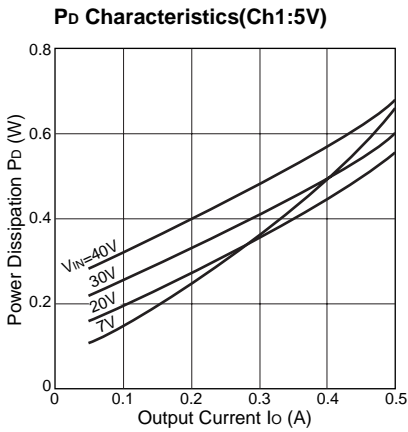
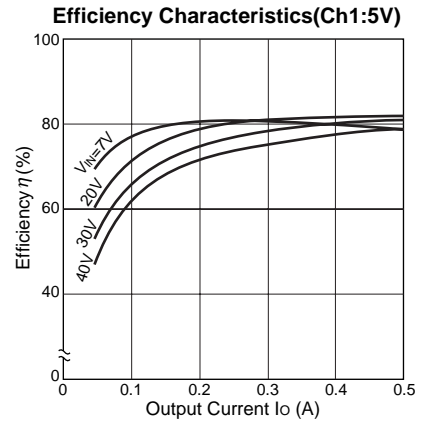
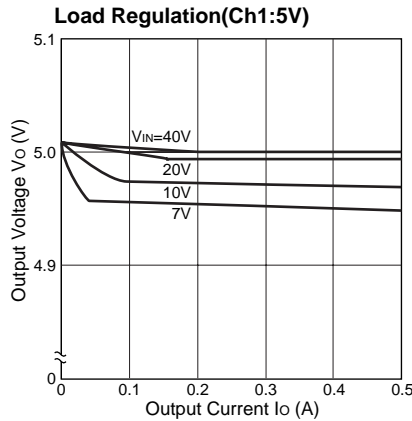
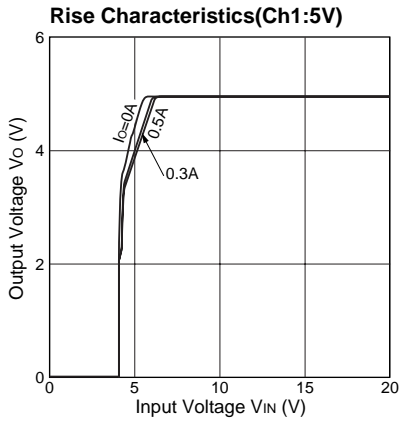

STA802M

