

Absolute Maximum Ratings			
Symbol	Conditions <sup>1)</sup>	Values	Units
Inverter	(Chopper see SKiiP 22 NAB 12 T18)		
V <sub>CEsat</sub>		1200	V
V <sub>GES</sub>		± 20	V
I <sub>C</sub>	T <sub>heatsink</sub> = 25 / 80 °C	45 / 30	A
I <sub>CM</sub>	t <sub>p</sub> < 1 ms; T <sub>heatsink</sub> = 25 / 80 °C	90 / 60	A
I <sub>F</sub> = -I <sub>C</sub>	T <sub>heatsink</sub> = 25 / 80 °C	38 / 26	A
I <sub>FM</sub> = -I <sub>CM</sub>	t <sub>p</sub> < 1 ms; T <sub>heatsink</sub> = 25 / 80 °C	76 / 52	A
Bridge Rectifier			
V <sub>RRM</sub>		1500	V
I <sub>D</sub>	T <sub>heatsink</sub> = 80 °C	35	A
I <sub>FSM</sub>	t <sub>p</sub> = 10 ms; sin. 180 °, T <sub>J</sub> = 25 °C	700	A
I <sup>2</sup> t	t <sub>p</sub> = 10 ms; sin. 180 °, T <sub>J</sub> = 25 °C	2400	A <sup>2</sup> s
T <sub>J</sub>		- 40 ... + 150	°C
T <sub>stg</sub>		- 40 ... + 125	°C
V <sub>isol</sub>	AC, 1 min.	2500	V

### MiniSKiiP 3 SEMIKRON integrated intelligent Power SKiiP 31 NAB 12 T11 3-phase bridge rectifier + braking chopper 3-phase bridge inverter

Case M3

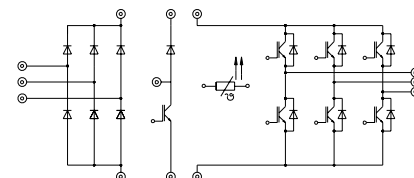

UL recognized file no. E63532

#### Options

- also available with powerful chopper. For characteristics please refer to Inverter IGBT

<sup>1)</sup> T<sub>heatsink</sub> = 25 °C, unless otherwise specified

<sup>2)</sup> CAL = Controlled Axial Lifetime Technology (soft and fast recovery)

\* For diagrams of the Chopper IGBT please refer to SKiiP 22 NAB 12 T18

Characteristics					
Symbol	Conditions <sup>1)</sup>	min.	typ.	max.	Units
IGBT - Inverter					
V <sub>CEsat</sub>	I <sub>C</sub> = 30 A T <sub>J</sub> = 25 (125) °C	-	2,5(3,1)	3,0(3,7)	V
t <sub>d(on)</sub>	V <sub>CC</sub> = 600 V; V <sub>GE</sub> = ± 15 V	-	55	110	ns
t <sub>r</sub>	I <sub>C</sub> = 30 A; T <sub>J</sub> = 125 °C	-	55	110	ns
t <sub>d(off)</sub>	R <sub>gon</sub> = R <sub>goff</sub> = 39 Ω	-	400	600	ns
t <sub>f</sub>	inductive load	-	45	90	ns
E <sub>on</sub> + E <sub>off</sub>		-	7,8	-	mJ
C <sub>ies</sub>	V <sub>CE</sub> = 25 V; V <sub>GE</sub> = 0 V, 1 MHz	-	2,0	-	nF
R <sub>thjh</sub>	per IGBT	-	-	0,7	K/W
IGBT - Chopper *					
V <sub>CEsat</sub>	I <sub>C</sub> = 15 A T <sub>J</sub> = 25 (125) °C	-	2,5(3,1)	3,0(3,7)	V
t <sub>d(on)</sub>	V <sub>CC</sub> = 600 V; V <sub>GE</sub> = ± 15 V	-	55	110	ns
t <sub>r</sub>	I <sub>C</sub> = 15 A; T <sub>J</sub> = 125 °C	-	45	90	ns
t <sub>d(off)</sub>	R <sub>gon</sub> = R <sub>goff</sub> = 82 Ω	-	400	600	ns
t <sub>f</sub>	inductive load	-	70	100	ns
E <sub>on</sub> + E <sub>off</sub>		-	4,0	-	mJ
C <sub>ies</sub>	V <sub>CE</sub> = 25 V; V <sub>GE</sub> = 0 V, 1 MHz	-	1,0	-	nF
R <sub>thjh</sub>	per IGBT	-	-	1,4	K/W
Diode <sup>2)</sup> - Inverter (Diode <sup>2)</sup> - Chopper see SKiiP 22 NAB 12 T18)					
V <sub>F</sub> = V <sub>EC</sub>	I <sub>F</sub> = 25 A T <sub>J</sub> = 25 (125) °C	-	2,0(1,8)	2,5(2,3)	V
V <sub>TO</sub>	T <sub>J</sub> = 125 °C	-	1,0	1,2	V
r <sub>T</sub>	T <sub>J</sub> = 125 °C	-	32	44	mΩ
I <sub>RRM</sub>	I <sub>F</sub> = 25 A, V <sub>R</sub> = - 600 V	-	25	-	A
Q <sub>rr</sub>	di <sub>F</sub> /dt = - 500 A/μs	-	4,5	-	μC
E <sub>off</sub>	V <sub>GE</sub> = 0 V, T <sub>J</sub> = 125 °C	-	1,0	-	mJ
R <sub>thjh</sub>	per diode	-	-	1,2	K/W
Diode - Rectifier					
V <sub>F</sub>	I <sub>F</sub> = 35 A T <sub>J</sub> = 25 °C	-	1,2	-	V
R <sub>thjh</sub>	per diode	-	-	1,6	K/W
Temperature Sensor					
R <sub>TS</sub>	T = 25 / 100 °C		1000 / 1670		Ω
Mechanical Data					
M <sub>1</sub>	Mounting torque	2	-	2,5	Nm
Case			M3		

This technical information specifies semiconductor devices but promises no characteristics. No warranty or guarantee expressed or implied is made regarding delivery, performance or suitability.

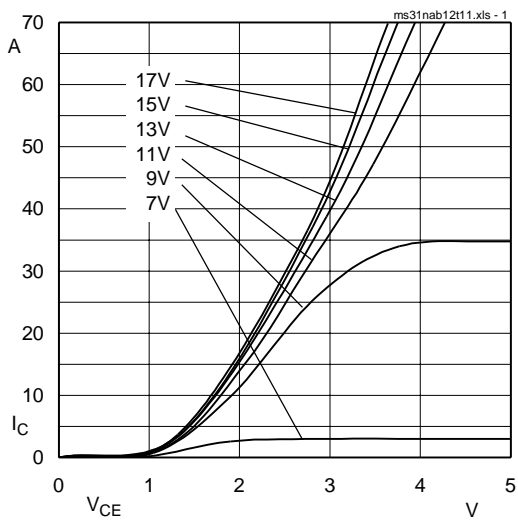

Fig. 1 Typ. output characteristic,  $t_p = 80 \mu s$ ;  $25 \text{ }^\circ\text{C}$

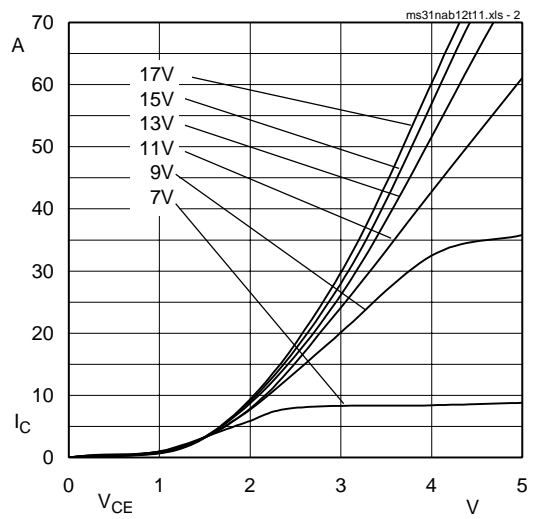

Fig. 2 Typ. output characteristic,  $t_p = 80 \mu s$ ;  $125 \text{ }^\circ\text{C}$

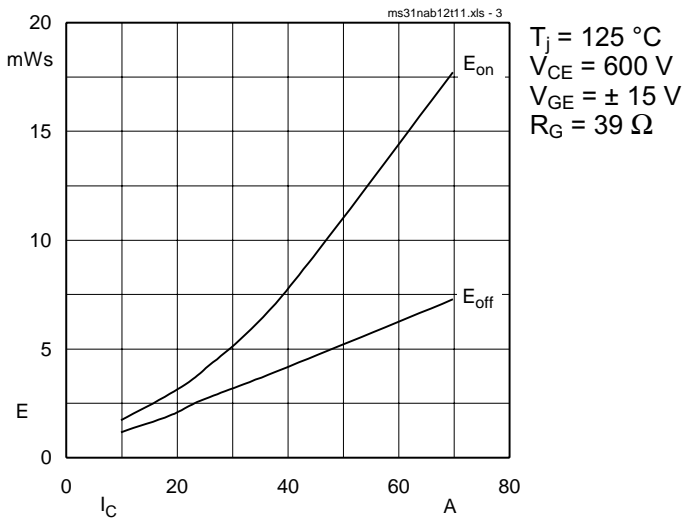

Fig. 3 Turn-on /-off energy =  $f(I_C)$

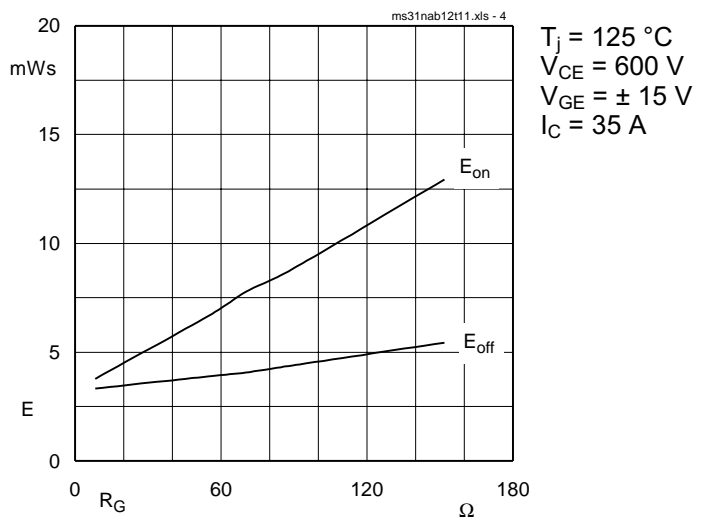

Fig. 4 Turn-on /-off energy =  $f(R_G)$

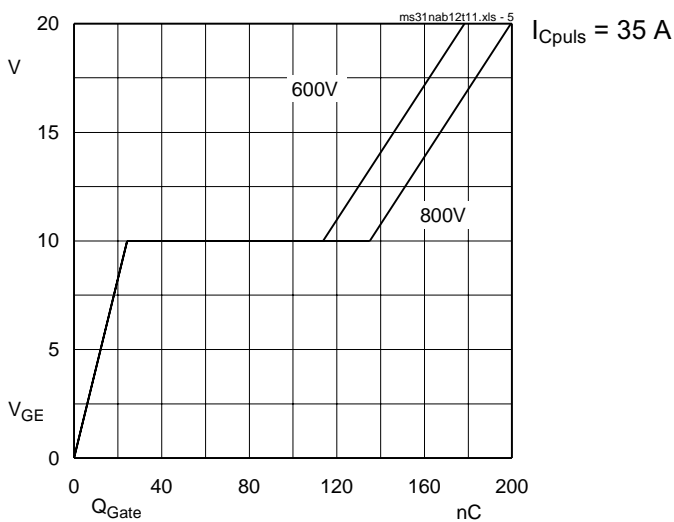

Fig. 5 Typ. gate charge characteristic

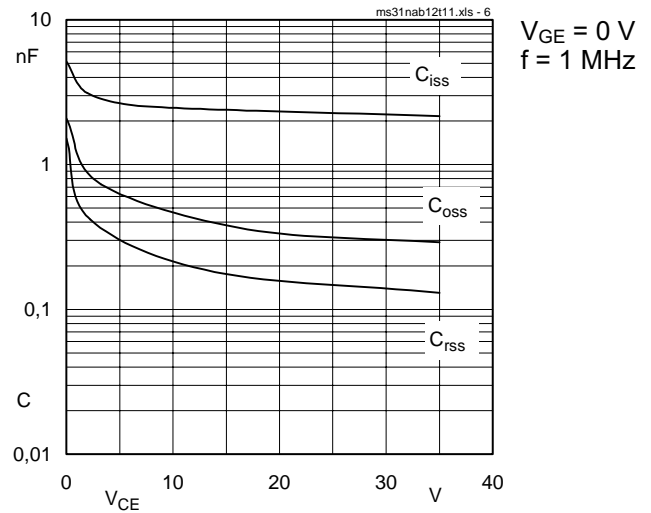

Fig. 6 Typ. capacitances vs.  $V_{CE}$

## MiniSKiiP 1200 V

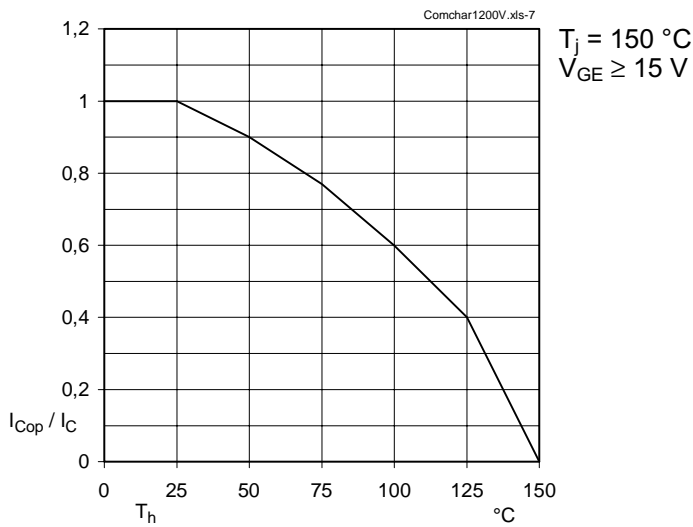

Fig. 7 Rated current of the IGBT  $I_{COp} / I_C = f(T_h)$

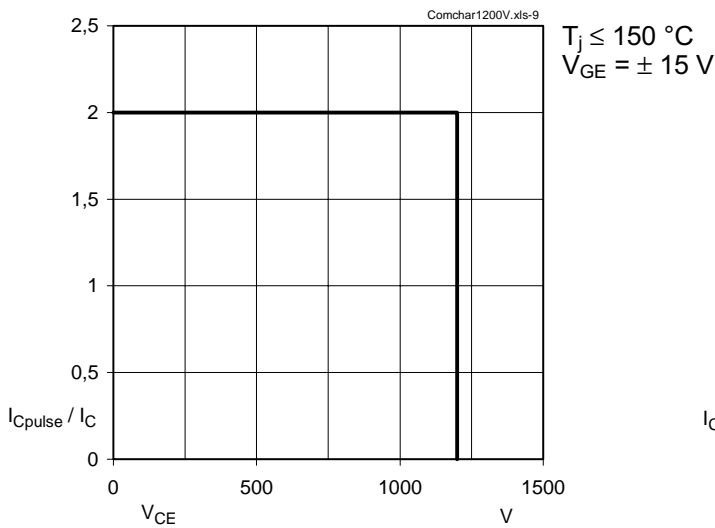

Fig. 9 Turn-off safe operating area (RBSOA) of the IGBT

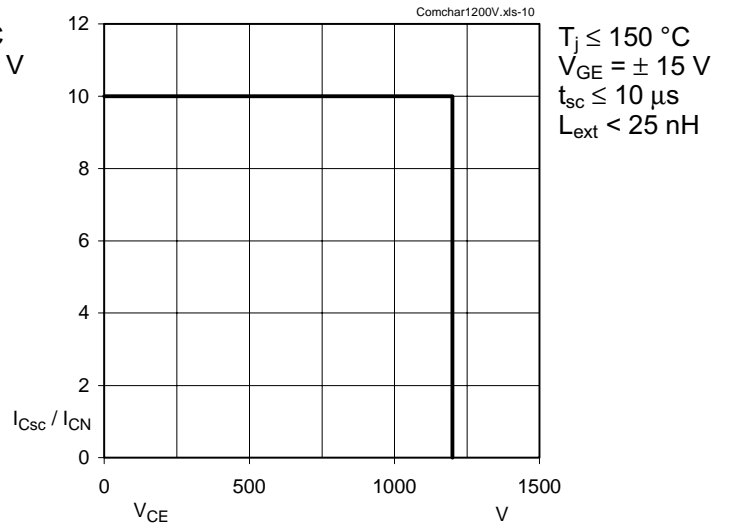

Fig. 10 Safe operating area at short circuit of the IGBT

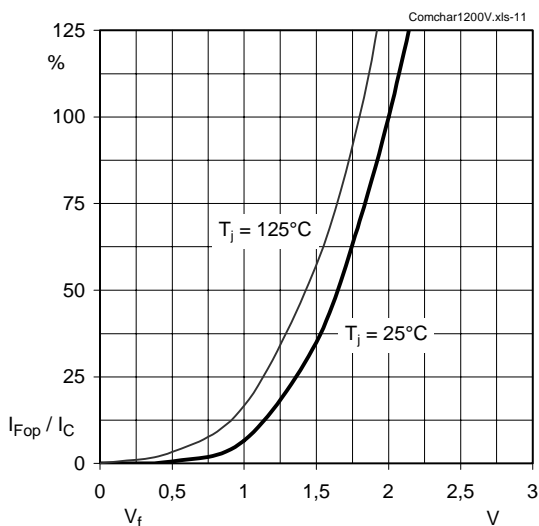

Fig. 11 Typ. freewheeling diode forward characteristic

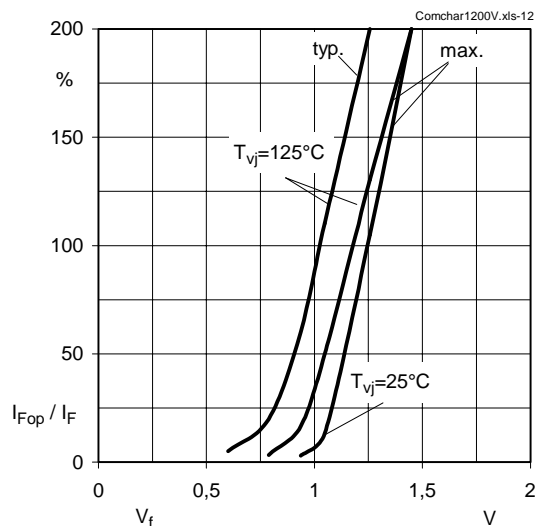
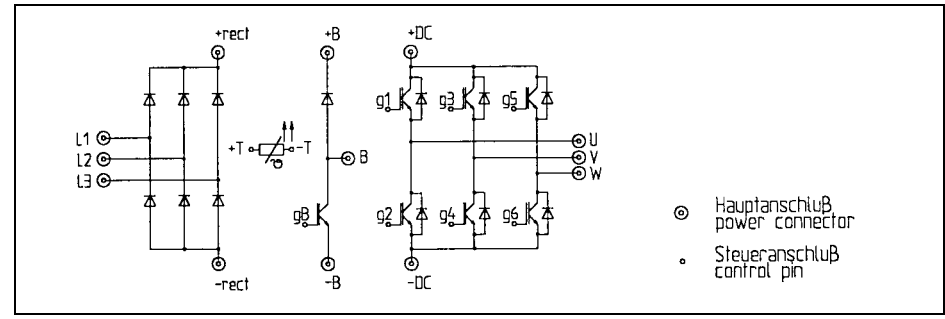

Fig. 12 Forward characteristic of the input bridge diode

# MiniSKiiP 3

- SKiiP 30 NAB 12 T10
- SKiiP 31 NAB 12 T11
- SKiiP 32 NAB 12 T1



- ⊙ Hauptanschluß power connector
- Steueranschluß control pin

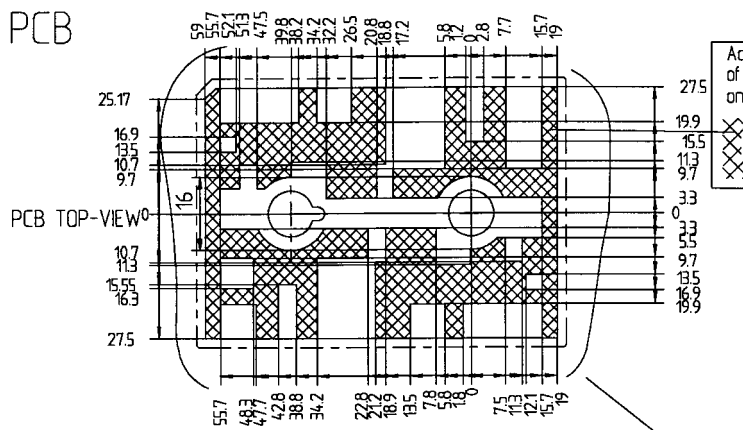

Accessible for mounting of SMD (max height 2.5) on PCB (by customer).

⊗ mounting area

## Mini-SKiiP 3

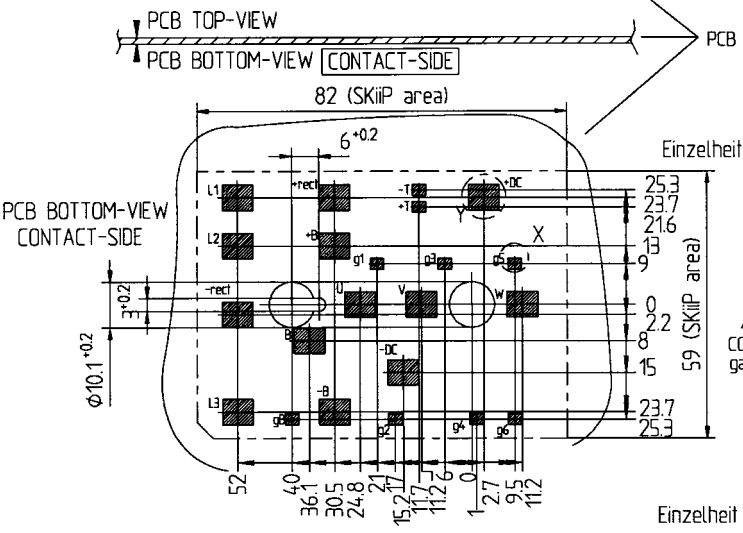
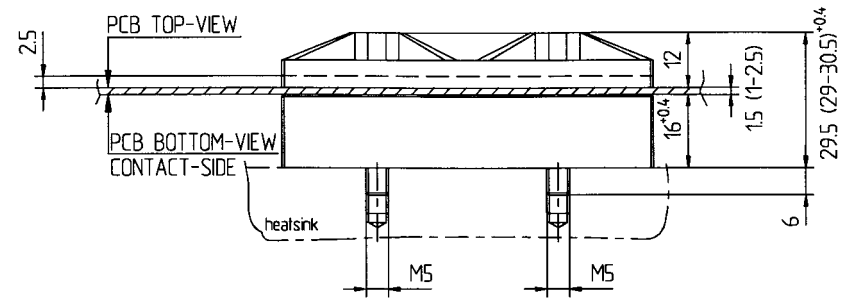

Einzelheit "Y" Maßstab 2 : 1

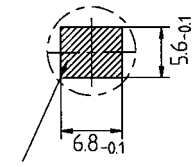

Einzelheit "X" Maßstab 2 : 1

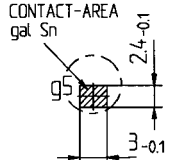

Bitte beachten Sie die Montagevorschrift  
For mounting please follow the assembly instruction

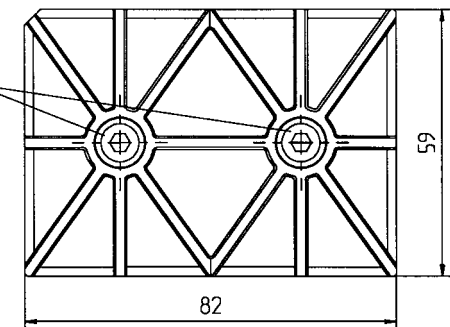

Tolerance: ISO 2768-f