

## N-Channel 30-V (D-S) MOSFET

### ■ Features

- Low  $r_{DS(on)}$  Provides Higher Efficiency and Extends Battery Life
- Miniature SO-8 Surface Mount Package Saves Board Space
- High power and current handling capability
- Low side high current DC-DC Converter applications

### ■ General Description

These miniature surface mount MOSFETs utilize High Cell Density process. Low  $r_{DS(on)}$  assures minimal power loss and conserves energy, making this device ideal for use in power management circuitry. Typical applications are PWM DC-DC converters, power management in portable and battery-powered products such as computers, printers, battery charger, telecommunication power system, and telephones power system.

### ■ Product Summary

$V_{DS}$ (V)	$r_{DS(on)}$ (m $\Omega$ )	$I_D$ (A)
30	13.5@ $V_{GS}=10V$	10
	20@ $V_{GS}=4.5V$	8

### ■ Pin Assignments

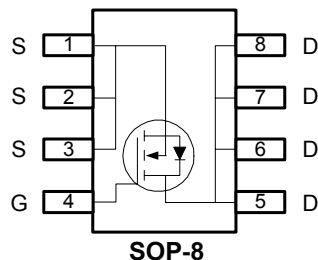

### ■ Pin Descriptions

Pin Name	Description
S	Source
G	Gate
D	Drain

### ■ Ordering information

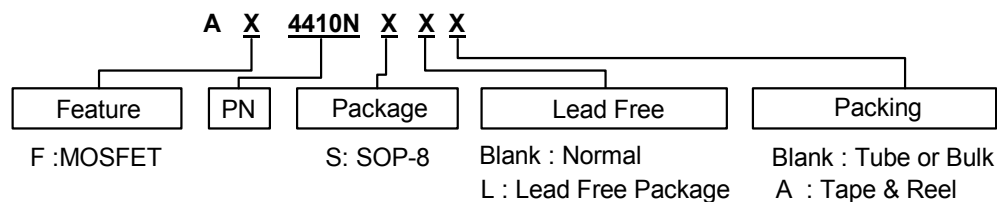



## N-Channel 30-V (D-S) MOSFET

### ■ Absolute Maximum Ratings ( $T_A=25^\circ\text{C}$ unless otherwise noted)

Symbol	Parameter	Rating	Units
$V_{DS}$	Drain-Source Voltage	30	V
$V_{GS}$	Gate-Source Voltage	$\pm 20$	V
$I_D$	Continuous Drain Current (Note 1)	$T_A=25^\circ\text{C}$	$\pm 10$
		$T_A=70^\circ\text{C}$	$\pm 8$
$I_{DM}$	Pulsed Drain Current (Note 2)	$\pm 50$	A
$I_S$	Continuous Source Current (Diode Conduction) (Note 1)	2.3	A
$P_D$	Power Dissipation (Note 1)	$T_A=25^\circ\text{C}$	3.1
		$T_A=70^\circ\text{C}$	2.2
$T_J, T_{STG}$	Operating Junction and Storage Temperature Range	-55 to 150	$^\circ\text{C}$

### ■ Thermal Resistance Ratings

Symbol	Parameter	Maximum	Units
$R_{\theta JC}$	Maximum Junction-to-Case (Note 1)	$t \leq 5 \text{ sec}$	25
$R_{\theta JA}$	Maximum Junction-to-Ambient (Note 1)	$t \leq 5 \text{ sec}$	50

Note 1: surface Mounted on 1"x 1" FR4 Board.

Note 2: Pulse width limited by maximum junction temperature

### ■ Specifications ( $T_A=25^\circ\text{C}$ unless otherwise noted)

Symbol	Parameter	Test Conditions	Limits			Unit
			Min.	Typ.	Max.	
<b>Static</b>						
$V_{(BR)DSS}$	Drain-Source breakdown Voltage	$V_{GS}=0V, I_D=250\mu A$	30	-	-	V
$V_{GS(th)}$	Gate-Threshold Voltage	$V_{DS}=V_{GS}, I_D=250\mu A$	1	1.95	3.0	V
$I_{GSS}$	Gate-Body Leakage	$V_{DS}=0V, V_{GS}=20V$	-	-	$\pm 100$	nA
$I_{DSS}$	Zero Gate Voltage Drain Current	$V_{DS}=24V, V_{GS}=0V$	-	-	1	$\mu A$
		$V_{DS}=24V, V_{GS}=0V, T_J=55^\circ\text{C}$	-	-	25	
$I_{D(on)}$	On-State Drain Current (Note 3)	$V_{DS}=5V, V_{GS}=10V$	20	-	-	A
$r_{DS(on)}$	Drain-Source On-Resistance (Note 3)	$V_{GS}=10V, I_D=10A$	-	11	13.5	m $\Omega$
		$V_{GS}=4.5V, I_D=8A$	-	15	20	
		$V_{GS}=10V, I_D=15A, T_J=55^\circ\text{C}$	-	12.5	15	
$g_{fs}$	Forward Transconductance (Note 3)	$V_{DS}=15V, I_D=10A$	-	40	-	S
$V_{SD}$	Diode Forward Voltage	$I_S=2.3A, V_{GS}=0V$	-	0.7	1.1	V
<b>Dynamic (Note 4)</b>						
$Q_g$	Total Gate Charge	$V_{DS}=15V, V_{GS}=5V, I_D=10A$	-	20	34	nC
$Q_{gs}$	Gate-Source Charge		-	7.0	-	
$Q_{gd}$	Gate-Drain Charge		-	7.0	-	
<b>Switching</b>						
$t_{d(on)}$	Turn-On Delay Time	$V_{DD}=25, R_L=25\Omega, I_D=1A, V_{GEN}=10V$	-	20	30	nS
$t_r$	Rise Time		-	9	20	
$t_{d(off)}$	Turn-Off Delay Time		-	70	102	
$t_f$	Fall-Time		-	20	81	
$t_{rr}$	Source-Drain Reverse Recovery Time	$I_F=2.3A, di/dt=100A/\mu s$	-	41	80	

Note 3: Pulse test:  $PW \leq 300\mu s$  duty cycle  $\leq 2\%$ .

Note 4: Guaranteed by design, not subject to production testing.

## Typical Performance Characteristics

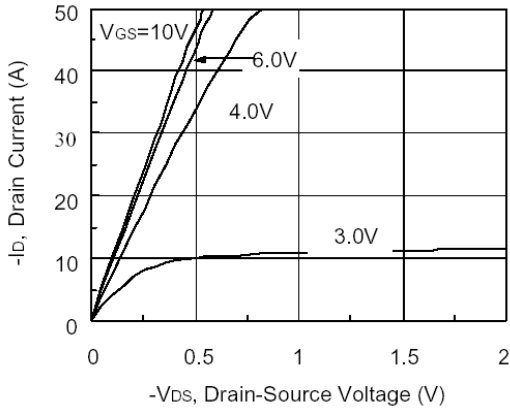

**Figure 1. On-Region Characteristics**

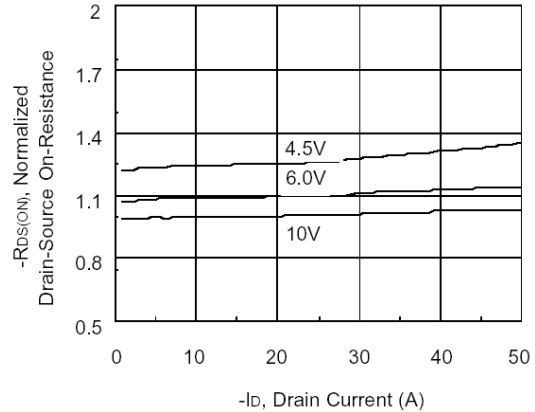

**Figure 2. On-Resistance with Drain Current**

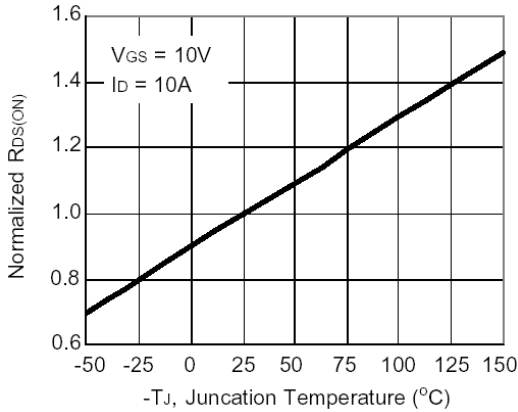

**Figure 3. On-Resistance Variation with Temperature**

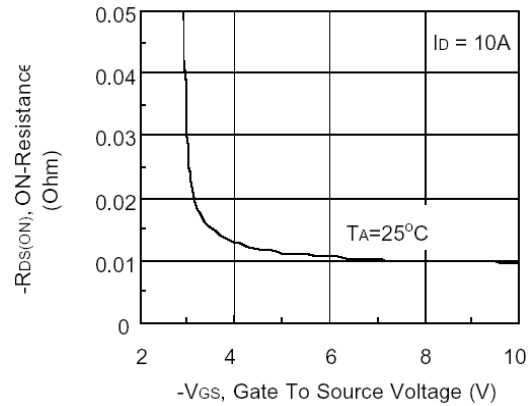

**Figure 4. On-Resistance Variation with Gate to Source Voltage**

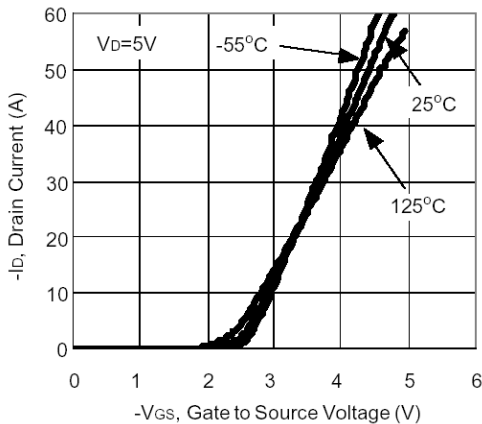

**Figure 5. Transfer Characteristics**

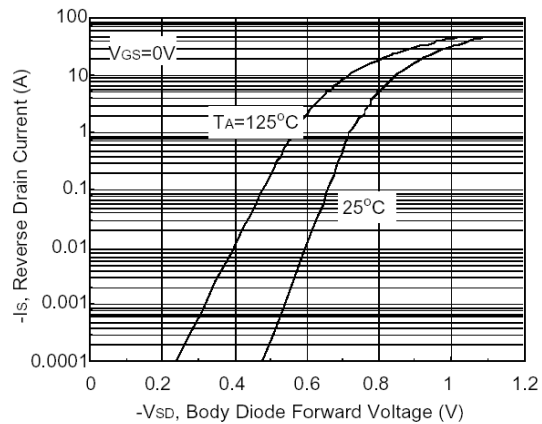

**Figure 6. Body Diode Forward Voltage Variation With Source Current and Temperature**

## N-Channel 30-V (D-S) MOSFET

### ■ Typical Performance Characteristics (Continued)

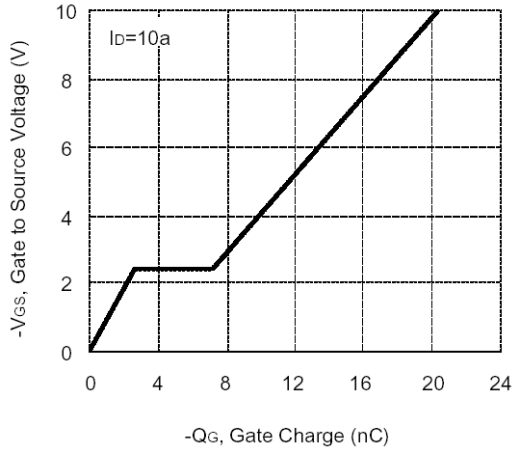

**Figure 7. Gate Charge Characteristics**

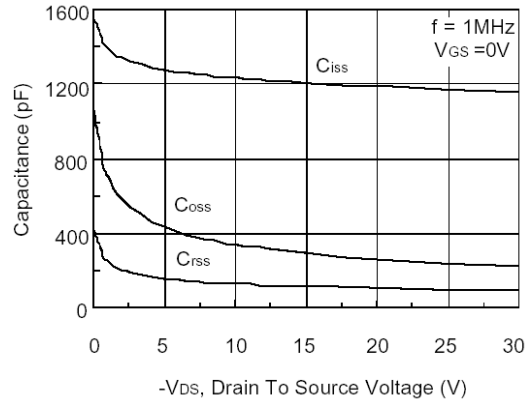

**Figure 8. Capacitance Characteristics**

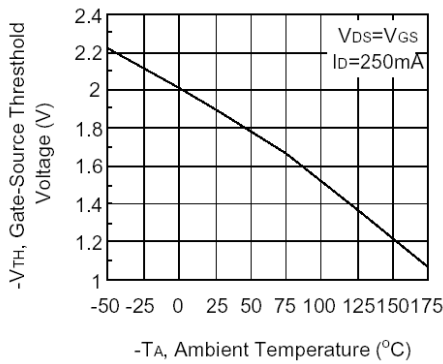

**Figure 9. Threshold v.s. Ambient Temperature**

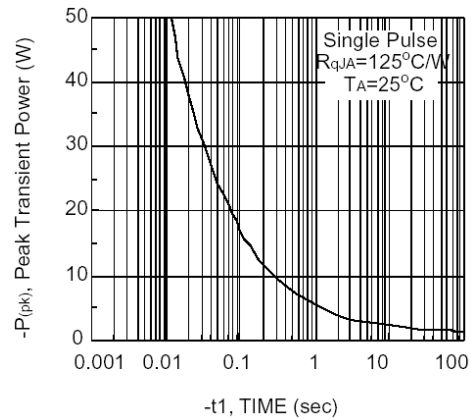

**Figure 10. Single Pulse Maximum Power Dissipation**

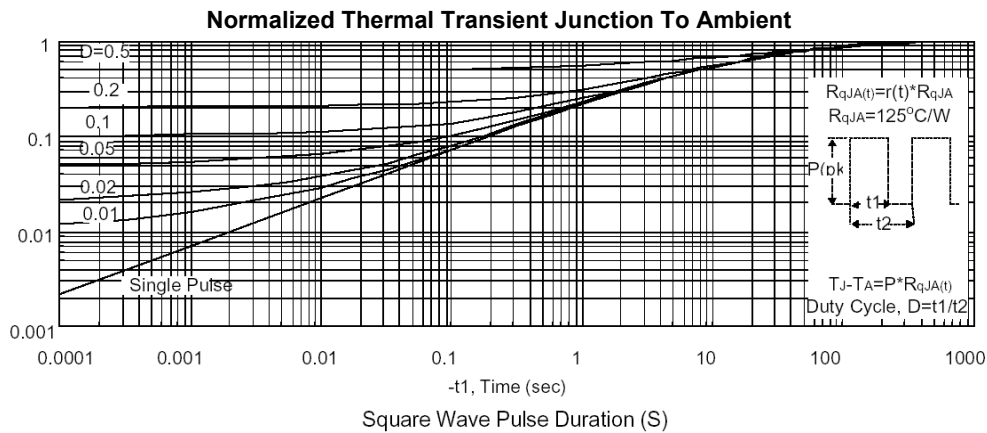
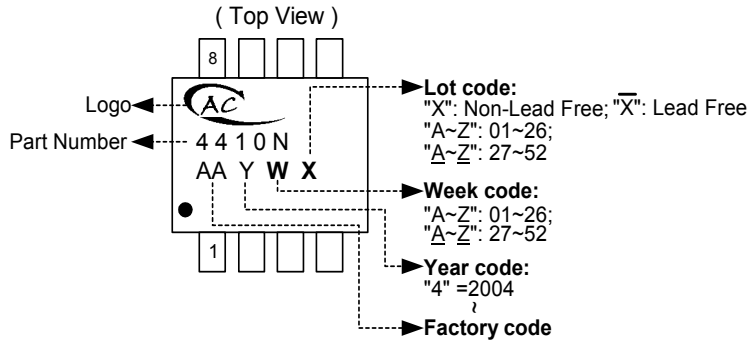

**Figure 11. Transient Thermal Response Curve**

## N-Channel 30-V (D-S) MOSFET

### ■ Marking Information

SOP-8L



### ■ Package Information

Package Type: SOP-8L

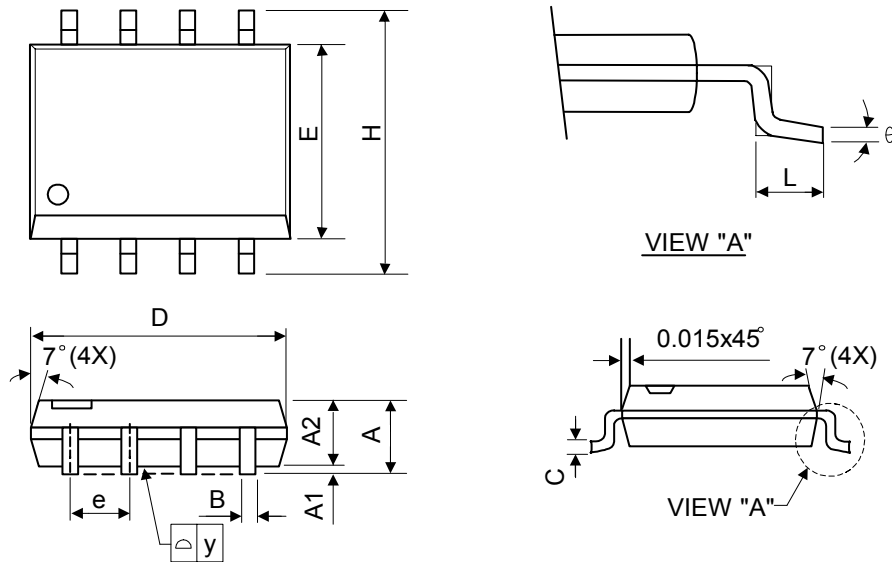

Symbol	Dimensions In Millimeters			Dimensions In Inches		
	Min.	Nom.	Max.	Min.	Nom.	Max.
A	1.40	1.60	1.75	0.055	0.063	0.069
A1	0.10	-	0.25	0.040	-	0.100
A2	1.30	1.45	1.50	0.051	0.057	0.059
B	0.33	0.41	0.51	0.013	0.016	0.020
C	0.19	0.20	0.25	0.0075	0.008	0.010
D	4.80	5.05	5.30	0.189	0.199	0.209
E	3.70	3.90	4.10	0.146	0.154	0.161
e	-	1.27	-	-	0.050	-
H	5.79	5.99	6.20	0.228	0.236	0.244
L	0.38	0.71	1.27	0.015	0.028	0.050
y	-	-	0.10	-	-	0.004
θ	0°	-	8°	0°	-	8°

This datasheet has been download from:

[www.datasheetcatalog.com](http://www.datasheetcatalog.com)

Datasheets for electronics components.