

FRD Type : KSF30A60B

OUTLINE DRAWING

FEATURES

- * Similar to TO-247AC(TO-3P)Case
- * Ultra-Fast Recovery
- * Low Forward Voltage Drop
- * Low Power Loss,High Efficiency
- * High Surge Current Capability
- * 200Volts thru 600Volts Type Available

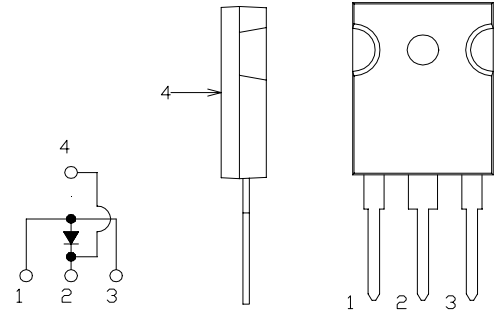

Maximum Ratings

Approx Net Weight: 5.55g

Rating	Symbol	KSF30A60B			Unit
Repetitive Peak Reverse Voltage	V_{RRM}	600			V
Average Rectified Output Current *1	I_O	30	$T_c=64^\circ\text{C}$	50 Hz half Sine Wave Resistive Load	A
RMS Forward Current	$I_{F(RMS)}$	47			A
Surge Forward Current	I_{FSM}	400	50Hz Half Sine Wave ,1cycle Non-repetitive		A
Operating JunctionTemperature Range	T_{jw}	-40 to +150			$^\circ\text{C}$
Storage Temperature Range	T_{stg}	-40 to +150			$^\circ\text{C}$
Mounting torque	F_{tor}	recommended torque = 0.5			$\text{N}\cdot\text{m}$

*1:Anode Terminals 1 and 3 Connected

Electrical • Thermal Characteristics

Characteristics	Symbol	Conditions	Min.	Typ.	Max.	Unit
Peak Reverse Current	I_{RM}	$T_j= 25^\circ\text{C}, V_{RM}= V_{RRM}$	-	-	50	μA
Peak Forward Voltage *1	V_{FM}	$T_j= 25^\circ\text{C}, I_{FM}= 30 \text{ A}$	-	-	1.7	V
Reverse Recovery Time	t_{rr}	$I_{FM}= 10\text{A},$ $-di/dt=50\text{A}/\mu\text{s}, T_a=25^\circ\text{C}$			60	ns
Thermal Resistance	$R_{th(j-c)}$	Junction to Case	-	-	1.4	$^\circ\text{C}/\text{W}$

*1:Anode Terminals 1 and 3 Connected

KSF30A60B OUTLINE DRAWING (Dimensions in mm)

