



# H431AM/BM/CM

ADJUSTABLE SHUNT REGULATOR

## Description

The H431XM series are three-terminal adjustable regulators with guaranteed thermal stability over applicable temperature ranges. The output voltage may be set to any value between  $V_{REF}$  (approximately 2.495 volts) and 36 volts with two external resistors. These devices have a typical dynamic output impedance of  $0.2\Omega$ . Active output circuitry provides a very sharp turn-on characteristic, making these devices excellent replacement for zener diodes in many applications.

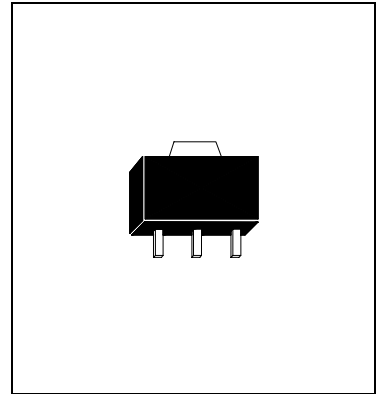

## Features

- Programmable output voltage
- Temperature coefficient is 50ppm/°C typical
- Temperature compensated for operation over full temperature range
- Low output noise voltage
- Fast turn on response

## Classification

Rank	A	B	C
$V_{REF}$	$2.495\pm 2\%$	$2.495\pm 1\%$	$2.495\pm 0.5\%$

## Absolute Maximum Ratings

( Operating temperature range applies unless otherwise specified )

Characteristics	Symbol	Value	Unit
Cathode Voltage	$V_{KA}$	37	V
Cathode Current Range (Continuous)	$I_K$	-100~+150	mA
Reference Input Current Range	$I_{REF}$	0.05~+10	mA
Power Dissipation	$P_D$	770	mW
Operating Temperature Range	$T_{opr}$	0~+70	°C
Storage Temperature Range	$T_{stg}$	-65~+150	°C



### Functional Block Diagram & Symbol

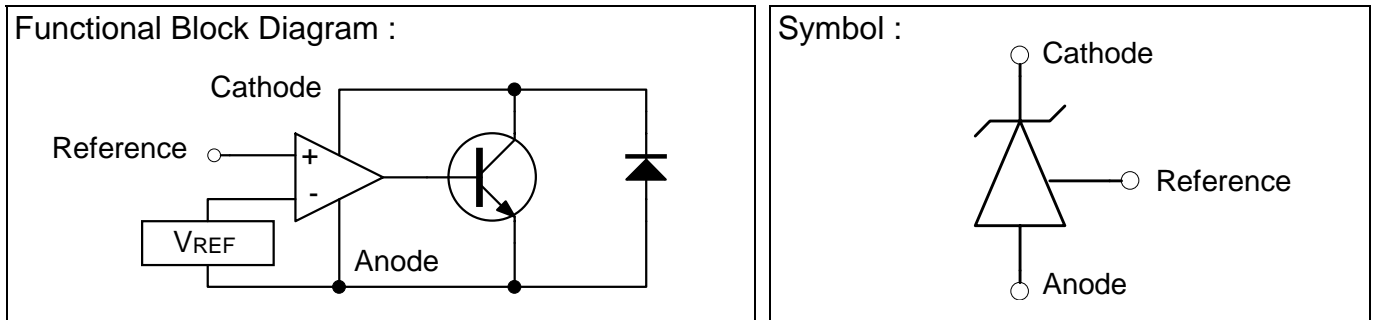

### Test Circuits

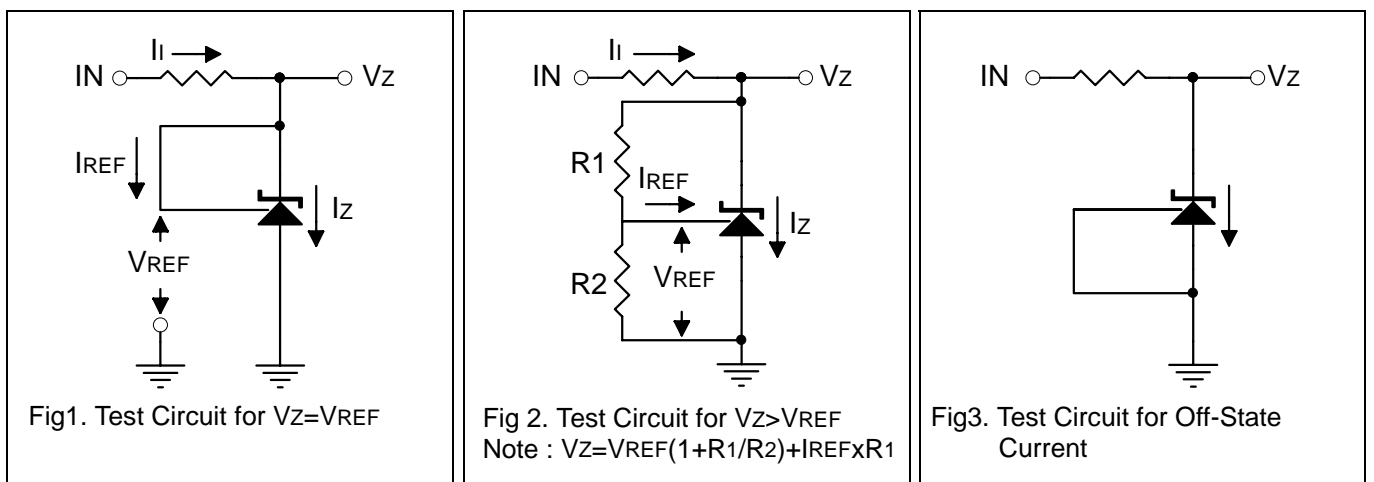

### Electrical Characteristics ( $T_a=25^\circ\text{C}$ unless otherwise specified )

Characteristics	Symbol	Test Conditions	Min	Typ	Max	Unit
Reference Input Voltage H431AM H431BM H431CM	$V_{REF}$	$V_{KA}=V_{REF}, I_K=10\text{mA}$	2.445	2.495	2.545	V
			2.470	2.495	2.520	
			2.480	2.495	2.510	
Deviation of Reference Input Voltage Over-Temperature	$V_{REF(\text{dev})}$	$V_{KA}=V_{REF}, I_K=10\text{mA}$ $T_{\min} \leq T_a \leq T_{\max}$	-	4	17	mV
Ratio of Change in Reference Input Voltage to the Change in Cathode Voltage	$\Delta V_{REF} / \Delta V_{KA}$	$I_K=10\text{mA}, \Delta V_{KA}=10\text{V}-V_{REF}$	-	-1.4	-2.7	mV
		$I_K=10\text{mA}, \Delta V_{KA}=36\text{V}-10\text{V}$	-	-1.0	-2.0	V
Reference Input Current	$I_{REF}$	$I_K=10\text{mA}, R_1=10\text{k}\Omega, R_2=\infty$	-	2	4	$\mu\text{A}$
Deviation of Reference Input Current Over Full Temperature Range	$I_{REF(\text{dev})}$	$I_K=10\text{mA}, R_1=10\text{k}\Omega, R_2=\infty, T_a=\text{Full Range}$	-	0.4	1.2	$\mu\text{A}$
Minimum Cathode Current for Regulation	$I_{K(\text{min})}$	$V_{KA}=V_{REF}$	-	0.4	1.0	mA
Off-State Cathode Current	$I_{K(\text{off})}$	$V_{KA}=36\text{V}, V_{REF}=0$	-	0.1	1.0	$\mu\text{A}$
Dynamic impedance	$Z_{KA}$	$V_{KA}=V_{REF}, f \leq 1.0\text{KHz}$ $I_K=1$ to $100\text{mA}$	-	0.2	0.5	$\Omega$



### Characteristics Curve

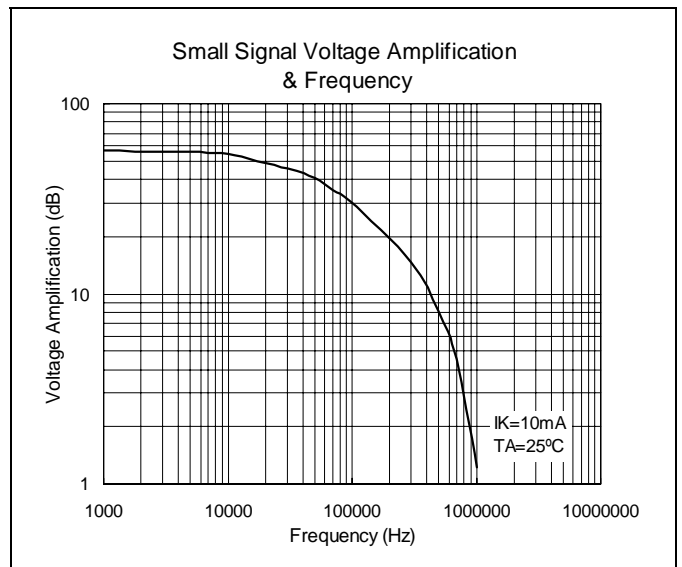
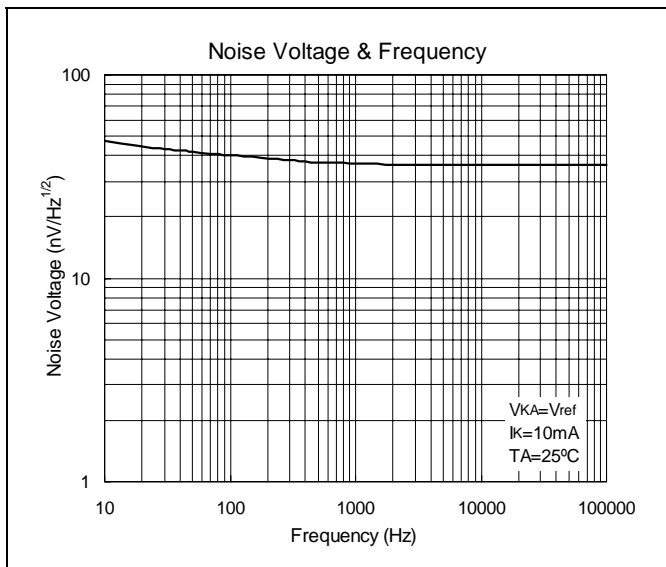
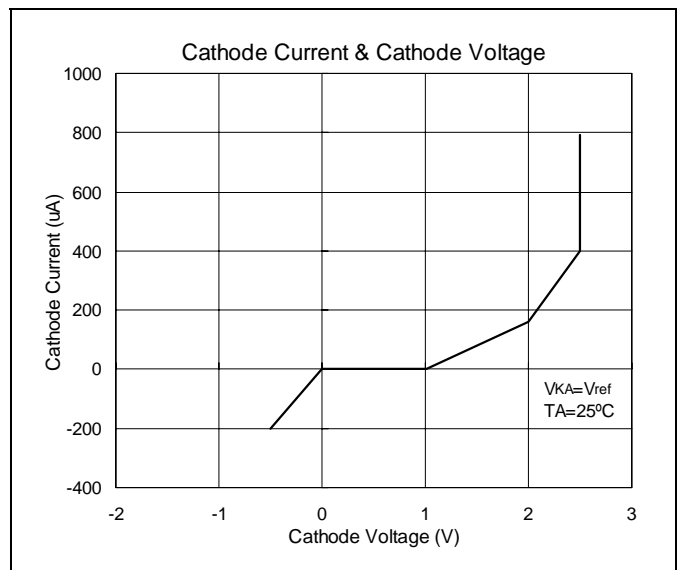
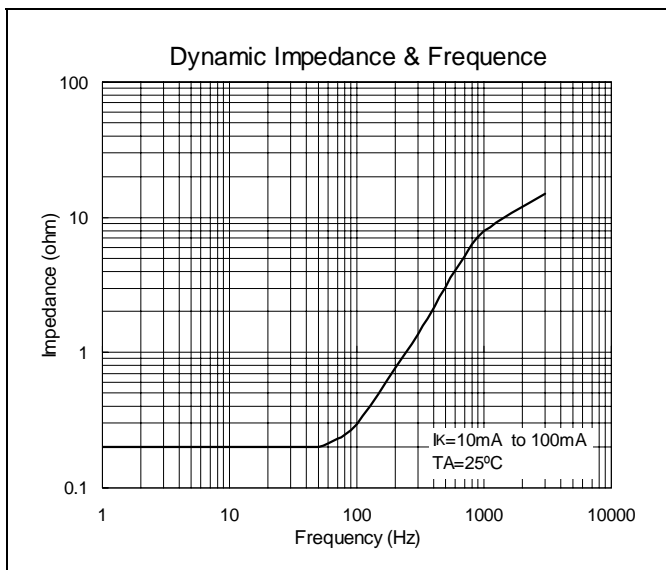
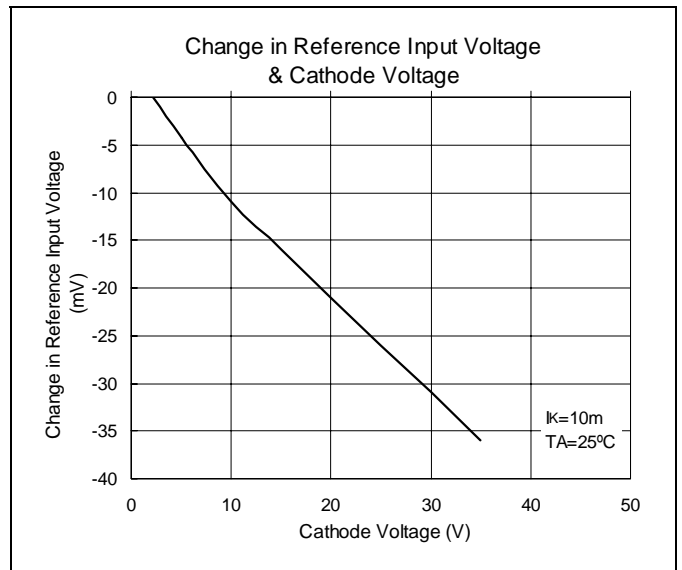
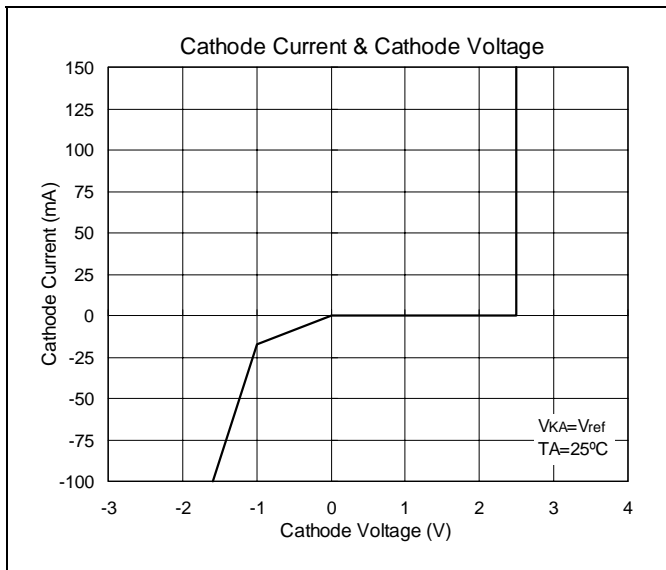



### SOT-89 Dimension

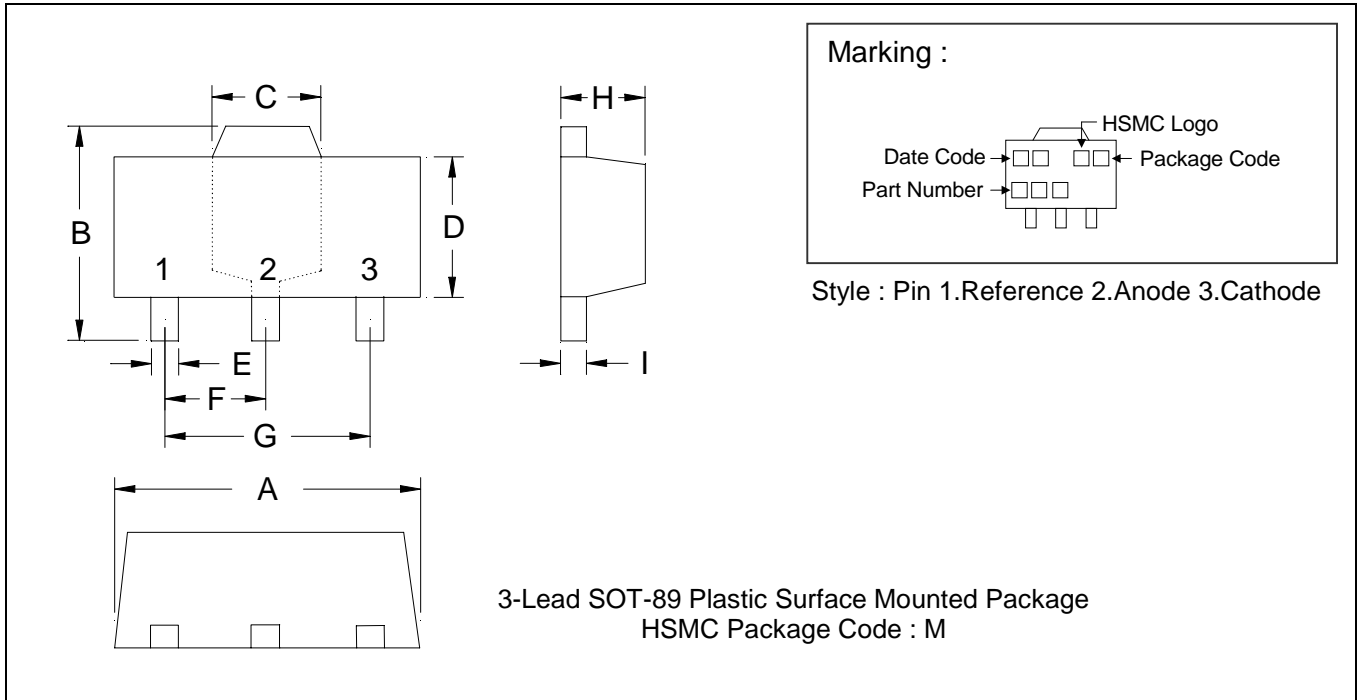

\*:Typical

DIM	Inches		Millimeters		DIM	Inches		Millimeters	
	Min.	Max.	Min.	Max.		Min.	Max.	Min.	Max.
A	0.1732	0.1811	4.40	4.60	F	0.0583	0.0598	1.48	1.52
B	0.1594	0.1673	4.05	4.25	G	0.1165	0.1197	2.96	3.04
C	0.0591	0.0663	1.50	1.70	H	0.0551	0.0630	1.40	1.60
D	0.0945	0.1024	2.40	2.60	I	0.0138	0.0161	0.35	0.41
E	0.0141	0.0201	0.36	0.51					

**Notes :** 1.Dimension and tolerance based on our Spec. dated May. 05,1996.  
 2.Controlling dimension : millimeters.  
 3.Maximum lead thickness includes lead finish thickness, and minimum lead thickness is the minimum thickness of base material.  
 4.If there is any question with packing specification or packing method, please contact your local HSMC sales office.

**Material :**

- Lead : 42 Alloy ; solder plating
- Mold Compound : Epoxy resin family, flammability solid burning class:UL94V-0

**Important Notice:**

- All rights are reserved. Reproduction in whole or in part is prohibited without the prior written approval of HSMC.
- HSMC reserves the right to make changes to its products without notice.
- **HSMC semiconductor products are not warranted to be suitable for use in Life-Support Applications, or systems.**
- HSMC assumes no liability for any consequence of customer product design, infringement of patents, or application assistance.

**Head Office And Factory :**

- **Head Office** (Hi-Sincerity Microelectronics Corp.) : 10F.,No. 61, Sec. 2, Chung-Shan N. Rd. Taipei Taiwan R.O.C.  
 Tel : 886-2-25212056 Fax : 886-2-25632712, 25368454
- **Factory 1** : No. 38, Kuang Fu S. Rd., Fu-Kou Hsin-Chu Industrial Park Hsin-Chu Taiwan. R.O.C  
 Tel : 886-3-5983621~5 Fax : 886-3-5982931
- **Factory 2** : No. 17-1, Ta-Tung Rd., Fu-Kou Hsin-Chu Industrial Park Hsin-Chu Taiwan. R.O.C  
 Tel : 886-3-5977061 Fax : 886-3-5979220