

# CIL Series Ordinary Type

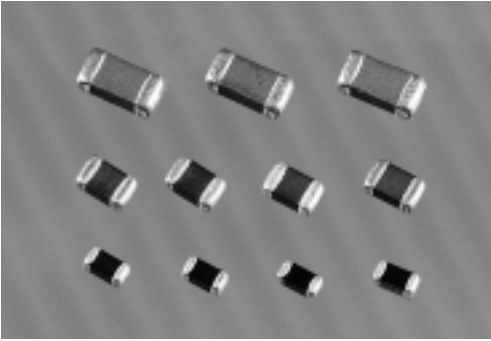

It has ferrite and 100% Ag as internal conductors, the CIL Series has excellent Q characteristics and eliminate crosstalk.

## FEATURES

- Magnetic shielding eliminates crosstalk, thus permitting higher mounting densities.
- Excellent solderability and high heat resistance for either flow or reflow soldering.
- Monolithic structure for high reliability.

## APPLICATIONS

- Resonance circuits, PLL circuits, Noise suppression etc.

## PART NUMBERING

**CI**    **L**    **21**    **○**    **5R6**    **K**    **N**    **E**  
 (1)    (2)    (3)    (4)    (5)    (6)    (7)    (8)

- (1) CHIP INDUCTOR  
 (2) L: Ordinary type  
 (3) Dimensions  
 (4) Material code (N, J, Y, S)  
 (5) Inductance (R10: 0.1 $\mu$ H ; 5R6: 5.6 $\mu$ H ; 100: 10 $\mu$ H)  
 (6) Tolerance (K:  $\pm$ 10% ; M:  $\pm$ 20%)  
 (7) Thickness option (N: Standard ; A: Thinner than standard ; B: Thicker than standard)  
 (8) Packaging style (C: paper tape, 7" reel ; E: embossed tape, 7" reel)

## DIMENSIONS

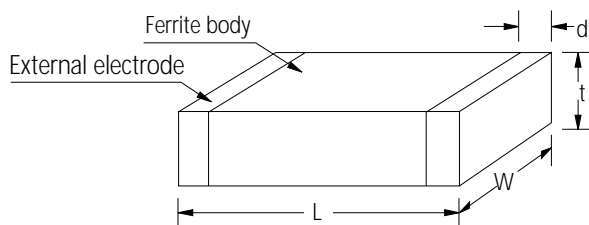

Unit : mm

Type	EIA Code	L	W	t	d
10	0603	1.6 $\pm$ 0.15	0.8 $\pm$ 0.15	0.8 $\pm$ 0.15	0.3 $\pm$ 0.2
21	0805	2.0 $\pm$ 0.2	1.25 $\pm$ 0.2	0.85 $\pm$ 0.2 1.25 $\pm$ 0.2	0.5+0.2,-0.3
31	1206	3.2 $\pm$ 0.2	1.6 $\pm$ 0.2	0.6 $\pm$ 0.2 1.1 $\pm$ 0.2	0.5+0.2,-0.3

**CIL 1608(0603) TYPE**

Part No. (1608 type)	Product's Thickness (mm)	Inductance ( $\mu$ H)	Q min	L, Q test frequency (MHZ)	SRF (MHZ), min	DC resistance ( $\Omega$ ),max	Rated current (mA),max
CIL 10N 47N□	0.80±0.15	0.047±20%, 10%	10	50	260	0.30	50
CIL 10N 68N□	0.80±0.15	0.068±20%, 10%	10	50	250	0.30	50
CIL 10N 82N□	0.80±0.15	0.082±20%, 10%	10	50	245	0.30	50
CIL 10N R10□	0.80±0.15	0.10±20%, 10%	15	25	240	0.50	50
CIL 10N R12□	0.80±0.15	0.12±20%, 10%	15	25	205	0.50	50
CIL 10N R15□	0.80±0.15	0.15±20%, 10%	15	25	180	0.60	50
CIL 10N R18□	0.80±0.15	0.18±20%, 10%	15	25	165	0.60	50
CIL 10N R22□	0.80±0.15	0.22±20%, 10%	15	25	150	0.80	50
CIL 10N R27□	0.80±0.15	0.27±20%, 10%	15	25	136	0.80	50
CIL 10N R33□	0.80±0.15	0.33±20%, 10%	15	25	125	0.85	35
CIL 10N R39□	0.80±0.15	0.39±20%, 10%	15	25	110	1.00	35
CIL 10N R47□	0.80±0.15	0.47±20%, 10%	15	25	105	1.35	35
CIL 10N R56□	0.80±0.15	0.56±20%, 10%	15	25	95	1.55	35
CIL 10N R68□	0.80±0.15	0.68±20%, 10%	15	25	80	1.70	35
CIL 10N R82□	0.80±0.15	0.82±20%, 10%	15	25	75	2.10	35
CIL 10J 1R0□	0.80±0.15	1.0±20%, 10%	35	10	70	0.60	25
CIL 10J 1R2□	0.80±0.15	1.2±20%, 10%	35	10	60	0.80	25
CIL 10J 1R5□	0.80±0.15	1.5±20%, 10%	35	10	55	0.80	25
CIL 10J 1R8□	0.80±0.15	1.8±20%, 10%	35	10	50	0.95	25
CIL 10J 2R2□	0.80±0.15	2.2±20%, 10%	35	10	45	1.15	15
CIL 10J 2R7□	0.80±0.15	2.7±20%, 10%	35	10	40	1.35	15
CIL 10J 3R3□	0.80±0.15	3.3±20%, 10%	35	10	38	1.55	15
CIL 10J 3R9□	0.80±0.15	3.9±20%, 10%	35	10	36	1.70	15
CIL 10J 4R7□	0.80±0.15	4.7±20%, 10%	35	10	33	2.10	15
CIL 10Y 5R6□	0.80±0.15	5.6±20%, 10%	35	4	22	1.55	5
CIL 10Y 6R8□	0.80±0.15	6.8±20%, 10%	35	4	20	1.70	5
CIL 10Y 8R2□	0.80±0.15	8.2±20%, 10%	35	4	18	2.10	5
CIL 10Y 100□	0.80±0.15	10.0±20%, 10%	35	2	17	2.55	3
CIL 10Y 120□	0.80±0.15	12.0±20%, 10%	35	2	15	2.75	3
CIL 10S 150□	0.80±0.15	15.0±20%	20	1	14	1.70	1
CIL 10S 180□	0.80±0.15	18.0±20%	20	1	13	1.85	1
CIL 10S 220□	0.80±0.15	22.0±20%	20	1	11	2.10	1
CIL 10S 270□	0.80±0.15	27.0±20%	20	1	10	2.75	1
CIL 10S 330□	0.80±0.15	33.0±20%	20	0.4	9	2.95	1

□: Tolerance (K: ±10%, M: ±20%)

\*Test equipment: HP4291A + HP16193A

**CIL 2012(0805) TYPE**

Part No. (2012 type)	Product's Thickness (mm)	Inductance ( $\mu$ H)	Q min	L, Q test frequency (MHZ)	SRF (MHZ), min	DC resistance ( $\Omega$ ),max	Rated current (mA),max
CIL 21N 47N□	0.85±0.2	0.047±20%, 10%	15	50	320	0.20	300
CIL 21N 68N□	0.85±0.2	0.068±20%, 10%	15	50	280	0.20	300
CIL 21N 82N□	0.85±0.2	0.082±20%, 10%	15	50	255	0.20	300
CIL 21N R10□	0.85±0.2	0.10±20%, 10%	20	25	235	0.30	250
CIL 21N R12□	0.85±0.2	0.12±20%, 10%	20	25	220	0.30	250
CIL 21N R15□	0.85±0.2	0.15±20%, 10%	20	25	200	0.40	250
CIL 21N R18□	0.85±0.2	0.18±20%, 10%	20	25	185	0.40	250
CIL 21N R22□	0.85±0.2	0.22±20%, 10%	20	25	170	0.50	250
CIL 21N R27□	0.85±0.2	0.27±20%, 10%	20	25	150	0.50	250
CIL 21N R33□	0.85±0.2	0.33±20%, 10%	20	25	145	0.55	250
CIL 21N R39□	0.85±0.2	0.39±20%, 10%	25	25	135	0.65	200
CIL 21N R47□	1.25±0.2	0.47±20%, 10%	25	25	125	0.65	200
CIL 21N R56□	1.25±0.2	0.56±20%, 10%	25	25	115	0.75	150
CIL 21N R68□	1.25±0.2	0.68±20%, 10%	25	25	105	0.80	150
CIL 21N R82□	1.25±0.2	0.82±20%, 10%	25	25	100	1.00	150
CIL 21J 1R0□	0.85±0.2	1.0±20%, 10%	45	10	75	0.40	50
CIL 21J 1R2□	0.85±0.2	1.2±20%, 10%	45	10	65	0.50	50
CIL 21J 1R5□	0.85±0.2	1.5±20%, 10%	45	10	60	0.50	50
CIL 21J 1R8□	0.85±0.2	1.8±20%, 10%	45	10	55	0.60	50
CIL 21J 2R2□	0.85±0.2	2.2±20%, 10%	45	10	50	0.65	30
CIL 21J 2R7□	1.25±0.2	2.7±20%, 10%	45	10	45	0.75	30
CIL 21J 3R3□	1.25±0.2	3.3±20%, 10%	45	10	41	0.80	30
CIL 21J 3R9□	1.25±0.2	3.9±20%, 10%	45	10	38	0.90	30
CIL 21J 4R7□	1.25±0.2	4.7±20%, 10%	45	10	35	1.00	30
CIL 21Y 5R6□	1.25±0.2	5.6±20%, 10%	50	4	32	0.90	15
CIL 21Y 6R8□	1.25±0.2	6.8±20%, 10%	50	4	29	1.00	15
CIL 21Y 8R2□	1.25±0.2	8.2±20%, 10%	50	4	26	1.10	15
CIL 21Y 100□	1.25±0.2	10.0±20%, 10%	50	2	24	1.15	15
CIL 21Y 120□	1.25±0.2	12.0±20%, 10%	50	2	22	1.25	15
CIL 21S 150□	1.25±0.2	15.0±20%	30	1	19	0.80	5
CIL 21S 180□	1.25±0.2	18.0±20%	30	1	18	0.90	5
CIL 21S 220□	1.25±0.2	22.0±20%	30	1	16	1.10	5
CIL 21S 270□	1.25±0.2	27.0±20%	30	1	14	1.15	5
CIL 21S 330□	1.25±0.2	33.0±20%	30	0.4	13	1.25	5

□: Tolerance (K: ±10%, M: ±20%)

\* Test equipment: HP4291A + HP16193A

## CIL 3216(1206) TYPE

Part No. (3216 type)	Product's Thickness (mm)	Inductance ( $\mu$ H)	Q min	L, Q test frequency (MHZ)	SRF (MHZ), min	DC resistance ( $\Omega$ ),max	Rated current (mA),max
CIL 31N 47N□	0.6±0.2	0.047±20%, 10%	20	50	320	0.15	300
CIL 31N 68N□	0.6±0.2	0.068±20%, 10%	20	50	280	0.25	300
CIL 31N R10□	0.6±0.2	0.10±20%, 10%	20	25	235	0.25	250
CIL 31N R12□	0.6±0.2	0.12±20%, 10%	20	25	220	0.30	250
CIL 31N R15□	0.6±0.2	0.15±20%, 10%	20	25	200	0.30	250
CIL 31N R18□	0.6±0.2	0.18±20%, 10%	20	25	185	0.40	250
CIL 31N R22□	0.6±0.2	0.22±20%, 10%	20	25	170	0.40	250
CIL 31N R27□	0.6±0.2	0.27±20%, 10%	20	25	150	0.50	250
CIL 31N R33□	0.6±0.2	0.33±20%, 10%	20	25	145	0.60	250
CIL 31N R39□	1.1±0.2	0.39±20%, 10%	25	25	135	0.50	200
CIL 31N R47□	1.1±0.2	0.47±20%, 10%	25	25	125	0.60	200
CIL 31N R56□	1.1±0.2	0.56±20%, 10%	25	25	115	0.70	150
CIL 31N R68□	1.1±0.2	0.68±20%, 10%	25	25	105	0.80	150
CIL 31N R82□	1.1±0.2	0.82±20%, 10%	25	25	100	0.90	150
CIL 31J 1R0 □	0.6±0.2	1.0±20%, 10%	45	10	75	0.40	100
CIL 31J 1R2 □	0.6±0.2	1.2±20%, 10%	45	10	65	0.50	100
CIL 31J 1R5 □	1.1±0.2	1.5±20%, 10%	45	10	60	0.50	50
CIL 31J 1R8 □	1.1±0.2	1.8±20%, 10%	45	10	55	0.50	50
CIL 31J 2R2 □	1.1±0.2	2.2±20%, 10%	45	10	50	0.60	50
CIL 31J 2R7 □	1.1±0.2	2.7±20%, 10%	45	10	45	0.60	50
CIL 31J 3R3 □	1.1±0.2	3.3±20%, 10%	45	10	41	0.70	50
CIL 31J 3R9 □	1.1±0.2	3.9±20%, 10%	45	10	38	0.80	50
CIL 31J 4R7 □	1.1±0.2	4.7±20%, 10%	45	10	35	0.90	50
CIL 31Y 5R6□	1.1±0.2	5.6±20%, 10%	50	4	32	0.70	25
CIL 31Y 6R8□	1.1±0.2	6.8±20%, 10%	50	4	29	0.80	25
CIL 31Y 8R2□	1.1±0.2	8.2±20%, 10%	50	4	26	0.90	25
CIL 31Y 100□	1.1±0.2	10.0±20%, 10%	50	2	24	1.00	25
CIL 31Y 120□	1.1±0.2	12.0±20%, 10%	50	2	22	1.05	15
CIL 31S 150 □	1.1±0.2	15.0±20%	35	1	19	0.70	5
CIL 31S 180 □	1.1±0.2	18.0±20%	35	1	18	0.70	5
CIL 31S 220 □	1.1±0.2	22.0±20%	35	1	16	0.90	5
CIL 31S 270□	1.1±0.2	27.0±20%	35	1	14	0.90	5
CIL 31S 330□	1.1±0.2	33.0±20%	35	0.4	13	1.05	5

□ : Tolerance (K : ±10%, M : ±20%)

\* Test equipment : HP4291A + HP16193A

PACKAGING

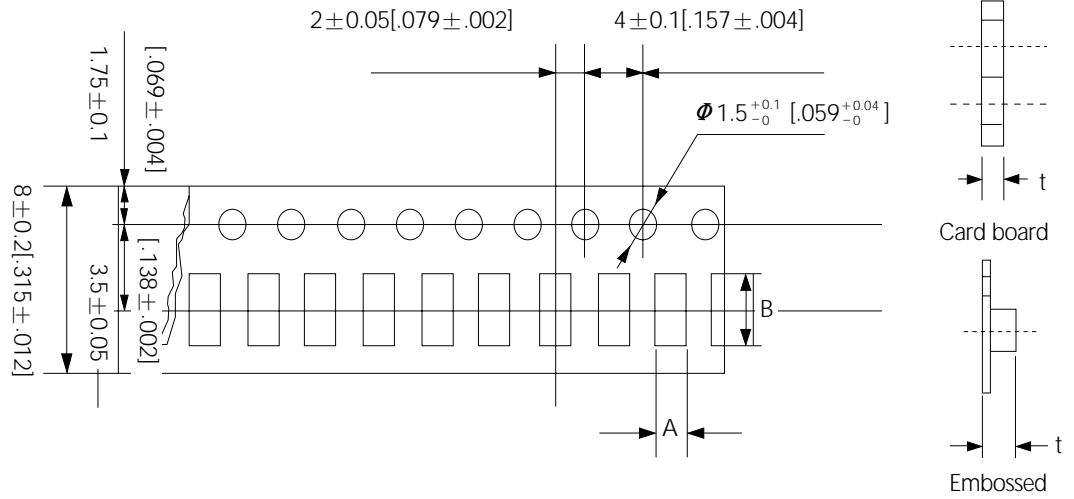

Unit: mm

Type	Tape	A	B	tmax	T	quantity/reel
10	Card	1.1±0.2 [.043±.008]	1.9±0.2 [.075±.008]	1.5 [.059]	0.8±0.15 [.031±.006]	4,000
21	Embossed	1.5±0.2 [.059±.008]	2.3±0.2 [.091±.008]	1.5 [.059]	0.85 [.033]	4,000
				2.0 [.079]	1.25 [.033]	2,000
31	Embossed	2.0±0.2 [.079±.008]	3.6±0.2 [.142±.008]	1.1 [.043]	0.6 [.024]	4,000
				2.0 [.079]	1.1 [.043]	3,000

T: chip's thickness

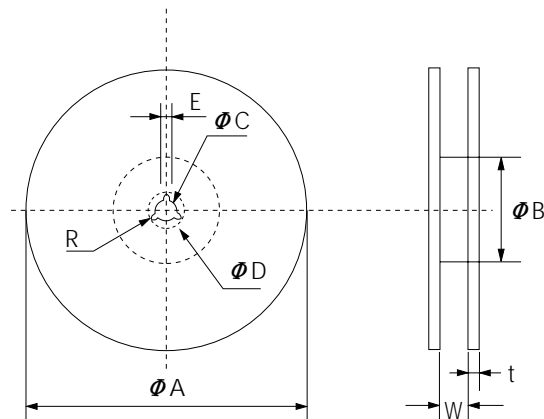

Unit: mm

A	B	C	D	E	W	t	R
φ 178±2	φ 50±1.0	φ 13±0.5	φ 21±0.8	2±0.5	10.0±1.0	1.2±0.5	1.0

## 1608 TYPE

### ■IMPEDANCE CHARACTERISTICS

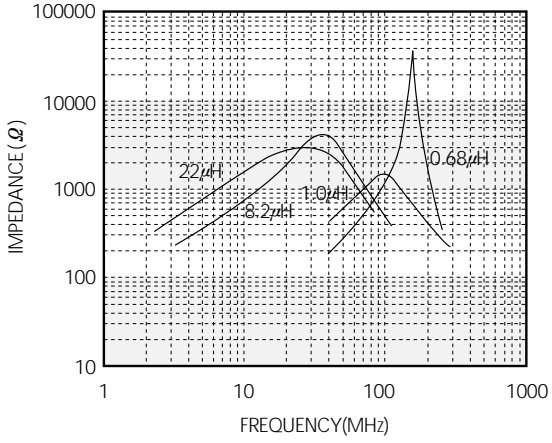

### ■Q CHARACTERISTICS

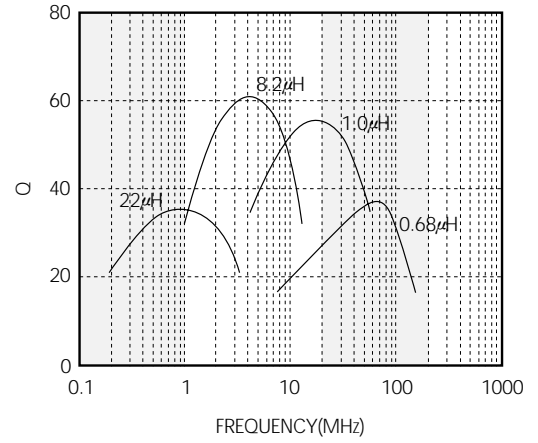

### ■DC BIAS CHARACTERISTICS

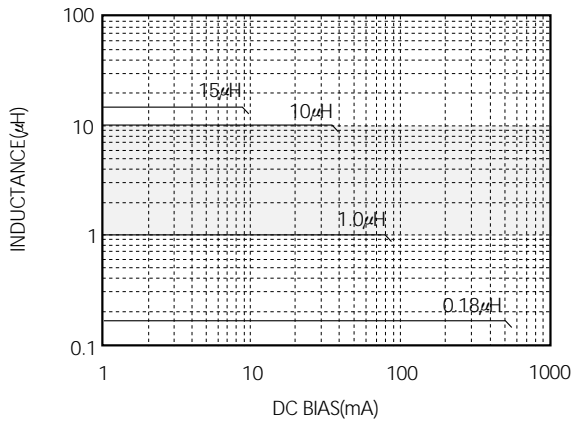

### ■TEMPERATURE CHARACTERISTICS

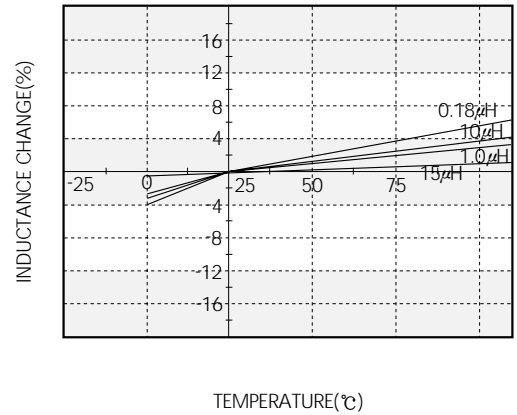

## 2012 TYPE

### ■IMPEDANCE CHARACTERISTICS

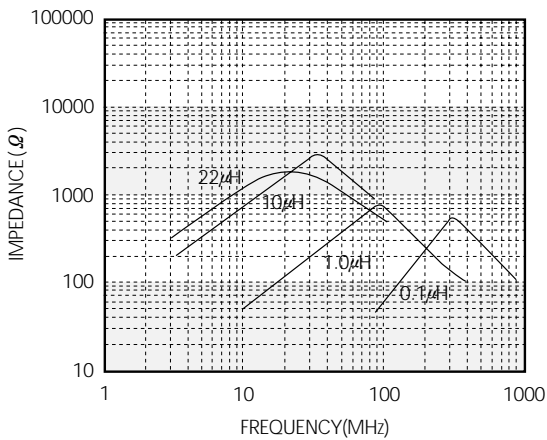

### ■Q CHARACTERISTICS

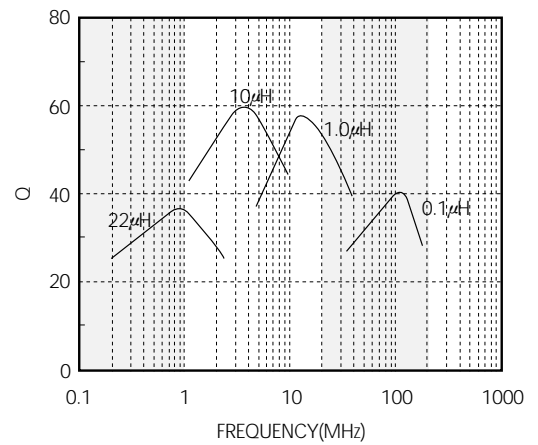

■ DC BIAS CHARACTERISTICS

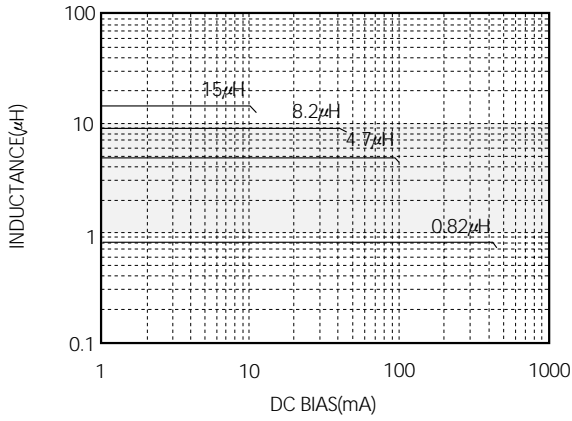

■ TEMPERATURE CHARACTERISTICS

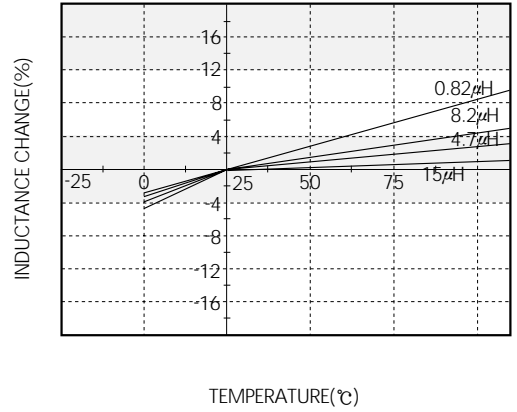

3216 TYPE

■ IMPEDANCE CHARACTERISTICS

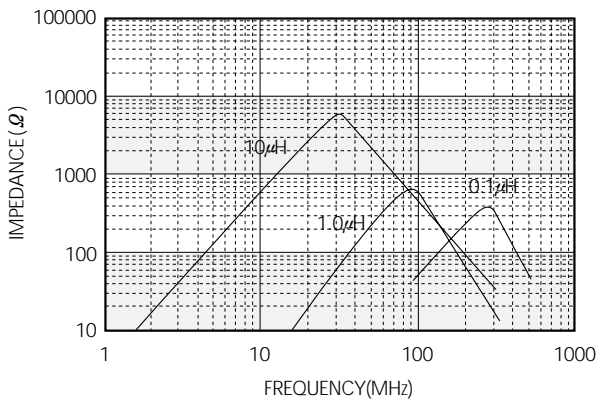

■ Q CHARACTERISTICS

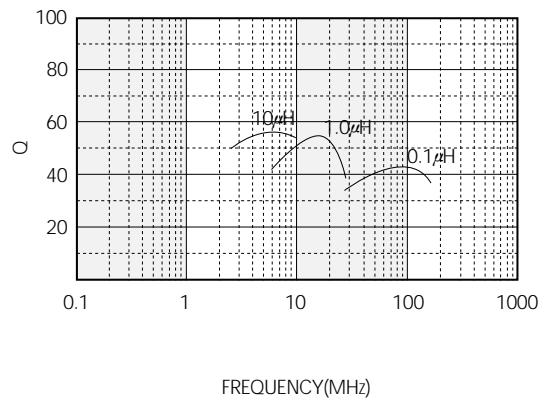

■ DC BIAS CHARACTERISTICS

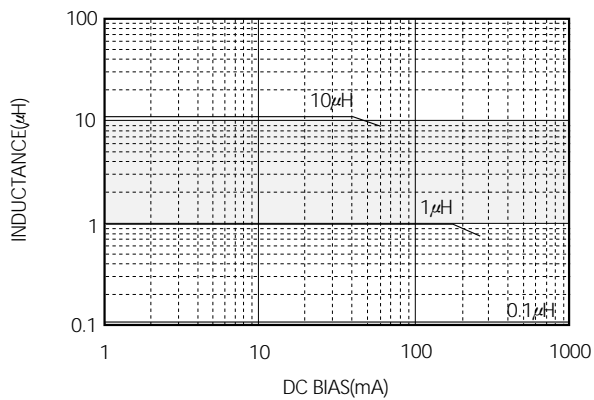

■ TEMPERATURE CHARACTERISTICS

