

# Silicon Power Rectifier S/R43 Series

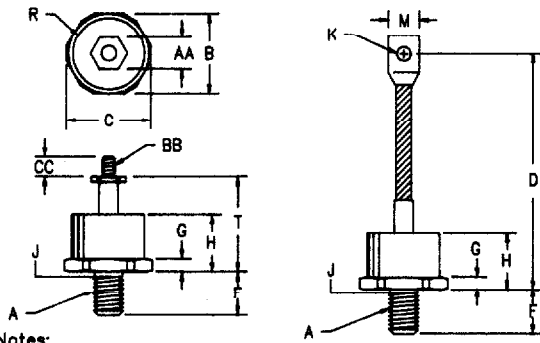

**Notes:**

1. 3/8-24 UNF-3A
2. Full threads within 2 1/2 threads
3. Standard polarity: Stud is Cathode  
Reverse polarity: Stud is Anode

Dim.	Inches		Millimeter		Notes
	Minimum	Maximum	Minimum	Maximum	
A	---	---	---	---	1
B	1.050	1.060	26.67	26.92	
C	---	1.166	---	29.61	
D	4.30	4.70	109.22	119.38	
F	.610	.640	15.49	16.25	
G	.213	.233	5.41	5.66	
H	---	.745	---	18.92	
J	.344	.373	8.74	9.47	2
K	.276	.286	7.01	7.26	
M	.465	.515	11.81	13.08	
R	---	.850	---	21.59	Dia
T	1.420	---	36.22	---	
AA	.427	.437	10.84	11.09	
BB	---	---	---	---	3
CC	.407	---	10.33	---	

## D0205AA (D08)



Microsemi Catalog Number	JEDEC Numbers	Peak Reverse Voltage
*S4310	1N412B, 1N3288A	100V
*S4320	1N3289A	200V
*S4330	1N3290A	300V
*S4340	1N3291A	400V
*S4350	1N3292A	500V
*S4360	1N3293A	600V
*S4380	1N3294A	800V
*S43100	1N3295A	1000V
*S43120	1N3296A	1200V
*S43140	1N3297A	1400V
*S43160	1N3298A	1600V

\*Change S to R in part number for Reverse Polarity  
Add the suffix TS to the end of the part number if a Top Stud is desired

- Soft recovery
- Glass Passivated Die
- 2500 Amps Surge Rating
- Glass to metal construction
- VRRM to 1600V
- Excellent reliability

Electrical Characteristics		
Average forward current	$I_F(AV)$ 150 Amps	$T_C = 148^\circ C$ , Half Sine Wave, $R_{\theta JC} = 0.35^\circ C/W$
Maximum surge current	IFSM 2500 Amps	8.3ms, half sine, $T_J = 200^\circ C$
Max $I^2 t$ for fusing	$I^2 t$ 26000 A <sup>2</sup> s	
Max peak forward voltage	$V_{FM}$ 1.1 Volts	$I_{FM} = 200A; T_J = 25^\circ C^*$
Max peak reverse current	$I_{RM}$ 200 $\mu A$	$V_{RRM, T_J} = 25^\circ C$
Max peak reverse current	$I_{RM}$ 5.0 mA	$V_{RRM, T_J} = 150^\circ C$
Max Recommended Operating Frequency	7.5kHz	

\*Pulse test: Pulse width 300  $\mu sec$ . Duty cycle 2%

Thermal and Mechanical Characteristics		
Storage temperature range	$T_{STG}$	$-65^\circ C$ to $200^\circ C$
Operating junction temp range	$T_J$	$-65^\circ C$ to $200^\circ C$
Maximum thermal resistance	$R_{\theta JC}$	0.35 $^\circ C/W$ Junction to Case
Typical thermal resistance	$R_{\theta JC}$	0.28 $^\circ C/W$ Junction to Case
Mounting torque		100 inch pounds maximum
Weight		2.75 ounces (78 grams) typical



PH: 303-469-2161  
FAX: 303-466-3775

# S/R43

Figure 1  
Typical Forward Characteristics

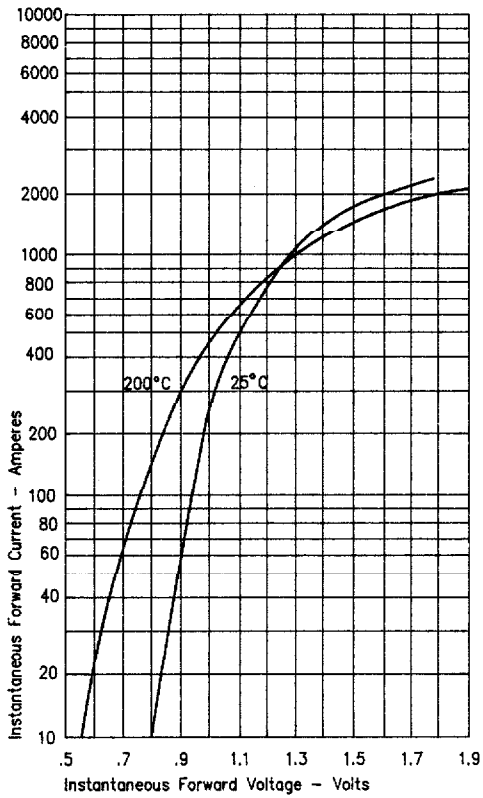

Figure 3  
Forward Current Derating

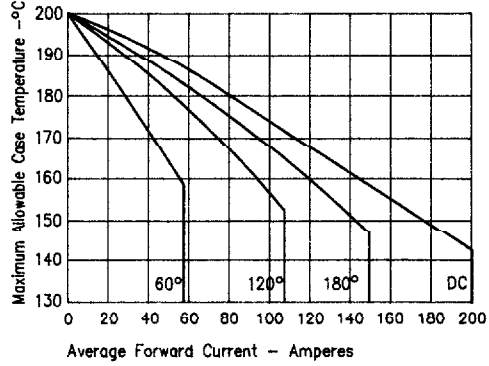

Figure 4  
Maximum Forward Power Dissipation

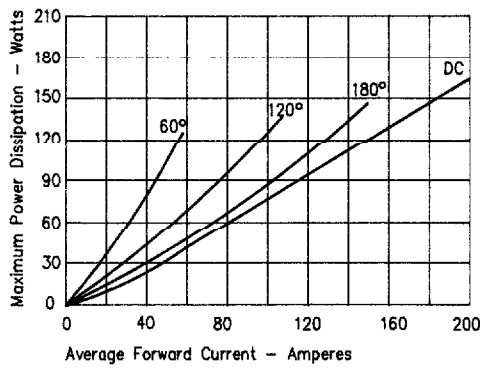

Figure 2  
Typical Reverse Characteristics

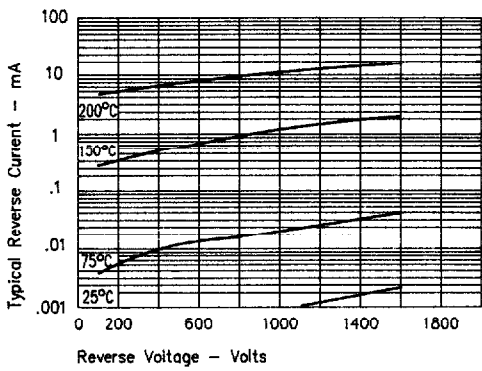
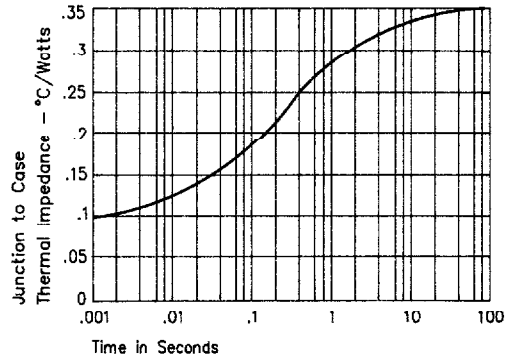
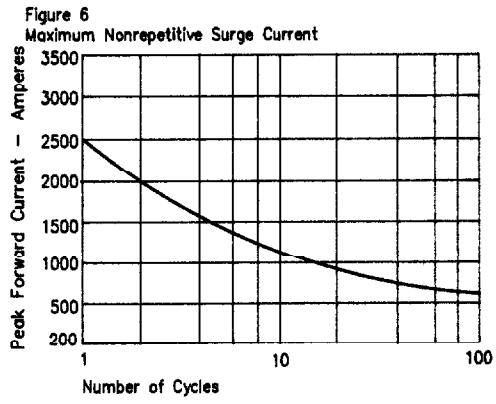

Figure 5  
Transient Thermal Impedance



# S/R43

|



E