

IGBT Power Module

Preliminary data

- Solderable Power module
- 3-phase full-bridge
- Including fast free-wheel diodes
- Package with insulated metal base plate

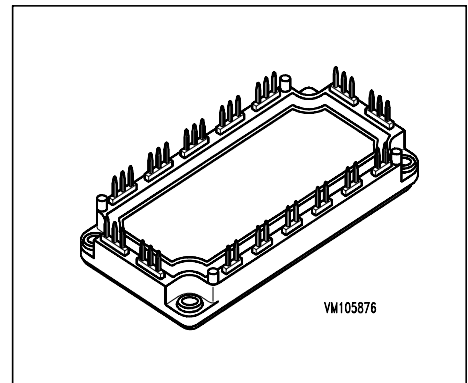

| Type | V_{CE} | I_C | Package | Ordering Code |
|--------------------|----------|-------|-------------|------------------|
| BSM 100 GD 120 DN2 | 1200V | 150A | ECONOPACK 3 | C67070-A2517-A67 |

Maximum Ratings

| Parameter | Symbol | Values | Unit |
|--|-------------|---------------|------------------|
| Collector-emitter voltage | V_{CE} | 1200 | V |
| Collector-gate voltage | V_{CGR} | 1200 | |
| $R_{GE} = 20 \text{ k}\Omega$ | | | |
| Gate-emitter voltage | V_{GE} | ± 20 | |
| DC collector current | I_C | | A |
| $T_C = 25 \text{ }^\circ\text{C}$ | | 150 | |
| $T_C = 80 \text{ }^\circ\text{C}$ | | 100 | |
| Pulsed collector current, $t_p = 1 \text{ ms}$ | I_{Cpuls} | | |
| $T_C = 25 \text{ }^\circ\text{C}$ | | 300 | |
| $T_C = 80 \text{ }^\circ\text{C}$ | | 200 | |
| Power dissipation per IGBT | P_{tot} | | W |
| $T_C = 25 \text{ }^\circ\text{C}$ | | 680 | |
| Chip temperature | T_j | + 150 | $^\circ\text{C}$ |
| Storage temperature | T_{stg} | -55 ... + 150 | |
| Thermal resistance, chip case | R_{thJC} | ≤ 0.182 | K/W |
| Diode thermal resistance, chip case | R_{thJCD} | ≤ 0.36 | |
| Insulation test voltage, $t = 1 \text{ min.}$ | V_{is} | 2500 | Vac |
| Creepage distance | - | 16 | mm |
| Clearance | - | 11 | |
| DIN humidity category, DIN 40 040 | - | F | - |
| IEC climatic category, DIN IEC 68-1 | - | 55 / 150 / 56 | |

Electrical Characteristics, at $T_j = 25\text{ °C}$, unless otherwise specified

| Parameter | Symbol | Values | | | Unit |
|-----------|--------|--------|------|------|------|
| | | min. | typ. | max. | |

Static Characteristics

| | | | | | |
|--|---------------|--------|------------|----------|----|
| Gate threshold voltage $V_{GE} = V_{CE}, I_C = 4\text{ mA}$ | $V_{GE(th)}$ | 4.5 | 5.5 | 6.5 | V |
| Collector-emitter saturation voltage $V_{GE} = 15\text{ V}, I_C = 100\text{ A}, T_j = 25\text{ °C}$ $V_{GE} = 15\text{ V}, I_C = 100\text{ A}, T_j = 125\text{ °C}$ | $V_{CE(sat)}$ | - - | 2.5 3.1 | 3 3.7 | |
| Zero gate voltage collector current $V_{CE} = 1200\text{ V}, V_{GE} = 0\text{ V}, T_j = 25\text{ °C}$ $V_{CE} = 1200\text{ V}, V_{GE} = 0\text{ V}, T_j = 125\text{ °C}$ | I_{CES} | - - | 1.5 6 | 2 - | mA |
| Gate-emitter leakage current $V_{GE} = 20\text{ V}, V_{CE} = 0\text{ V}$ | I_{GES} | - | - | 400 | nA |

AC Characteristics

| | | | | | |
|---|-----------|----|-----|---|----|
| Transconductance $V_{CE} = 20\text{ V}, I_C = 100\text{ A}$ | g_{fs} | 54 | - | - | S |
| Input capacitance $V_{CE} = 25\text{ V}, V_{GE} = 0\text{ V}, f = 1\text{ MHz}$ | C_{iss} | - | 6.5 | - | nF |
| Output capacitance $V_{CE} = 25\text{ V}, V_{GE} = 0\text{ V}, f = 1\text{ MHz}$ | C_{oss} | - | 1 | - | |
| Reverse transfer capacitance $V_{CE} = 25\text{ V}, V_{GE} = 0\text{ V}, f = 1\text{ MHz}$ | C_{rss} | - | 0.5 | - | |

Electrical Characteristics, at $T_j = 25\text{ °C}$, unless otherwise specified

| Parameter | Symbol | Values | | | Unit |
|-----------|--------|--------|------|------|------|
| | | min. | typ. | max. | |

Switching Characteristics, Inductive Load at $T_j = 125\text{ °C}$

| | | | | | |
|---|--------------|---|-----|-----|----|
| Turn-on delay time $V_{CC} = 600\text{ V}$, $V_{GE} = 15\text{ V}$, $I_C = 100\text{ A}$ $R_{Gon} = 6.8\ \Omega$ | $t_{d(on)}$ | - | 160 | 320 | ns |
| Rise time $V_{CC} = 600\text{ V}$, $V_{GE} = 15\text{ V}$, $I_C = 100\text{ A}$ $R_{Gon} = 6.8\ \Omega$ | t_r | - | 80 | 160 | |
| Turn-off delay time $V_{CC} = 600\text{ V}$, $V_{GE} = -15\text{ V}$, $I_C = 100\text{ A}$ $R_{Goff} = 6.8\ \Omega$ | $t_{d(off)}$ | - | 400 | 520 | |
| Fall time $V_{CC} = 600\text{ V}$, $V_{GE} = -15\text{ V}$, $I_C = 100\text{ A}$ $R_{Goff} = 6.8\ \Omega$ | t_f | - | 70 | 100 | |

Free-Wheel Diode

| | | | | | |
|---|----------|---|------------|----------|---------------|
| Diode forward voltage $I_F = 100\text{ A}$, $V_{GE} = 0\text{ V}$, $T_j = 25\text{ °C}$ $I_F = 100\text{ A}$, $V_{GE} = 0\text{ V}$, $T_j = 125\text{ °C}$ | V_F | - | 2.3 1.8 | 2.8 - | V |
| Reverse recovery time $I_F = 100\text{ A}$, $V_R = -600\text{ V}$, $V_{GE} = 0\text{ V}$ $di_F/dt = -800\text{ A}/\mu\text{s}$, $T_j = 125\text{ °C}$ | t_{rr} | - | 0.3 | - | |
| Reverse recovery charge $I_F = 100\text{ A}$, $V_R = -600\text{ V}$, $V_{GE} = 0\text{ V}$ $di_F/dt = -800\text{ A}/\mu\text{s}$ $T_j = 25\text{ °C}$ $T_j = 125\text{ °C}$ | Q_{rr} | - | 4 11 | - - | μC |

Power dissipation

$$P_{\text{tot}} = f(T_C)$$

parameter: $T_j \leq 150^\circ\text{C}$

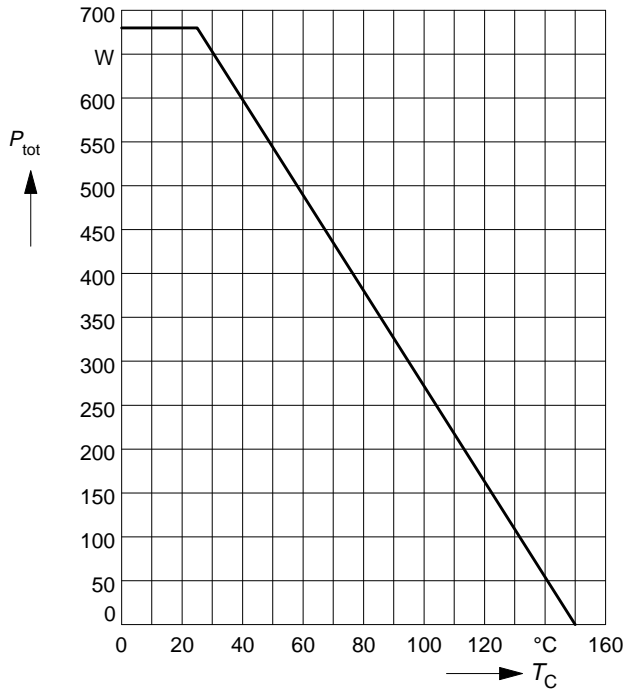

Safe operating area

$$I_C = f(V_{CE})$$

parameter: $D = 0, T_C = 25^\circ\text{C}, T_j \leq 150^\circ\text{C}$

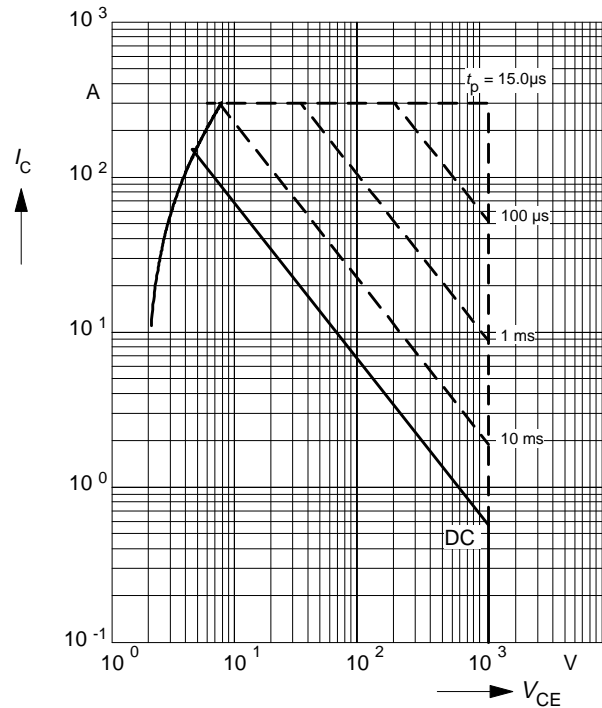

Collector current

$$I_C = f(T_C)$$

parameter: $V_{GE} \geq 15\text{ V}, T_j \leq 150^\circ\text{C}$

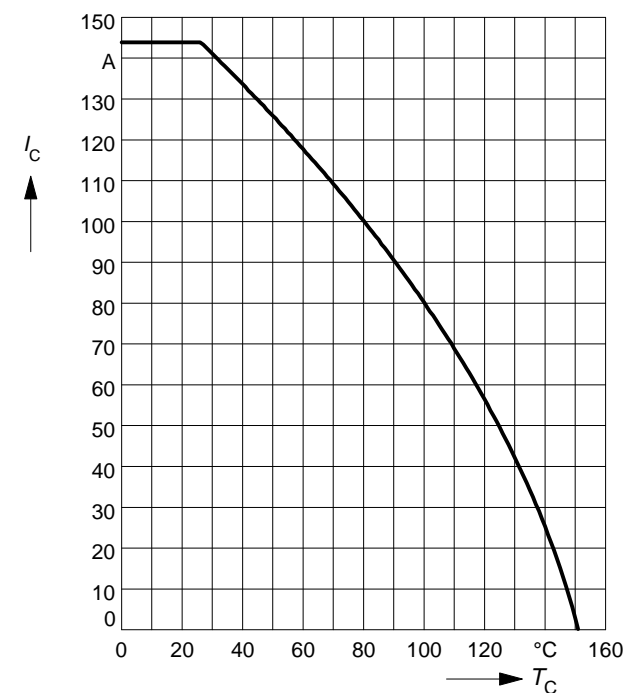

Transient thermal impedance IGBT

$$Z_{\text{thJC}} = f(t_p)$$

parameter: $D = t_p / T$

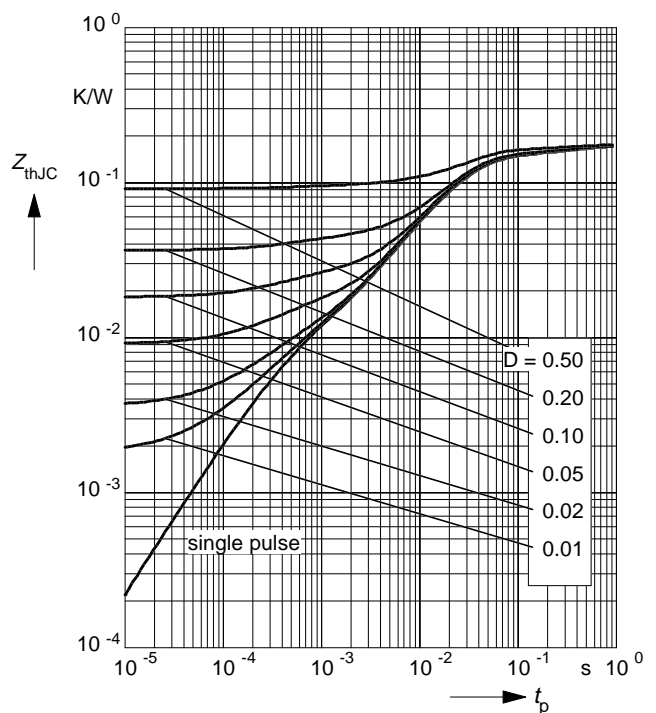

Typ. output characteristics

$$I_C = f(V_{CE})$$

parameter: $t_p = 80 \mu s$, $T_j = 25 \text{ }^\circ\text{C}$

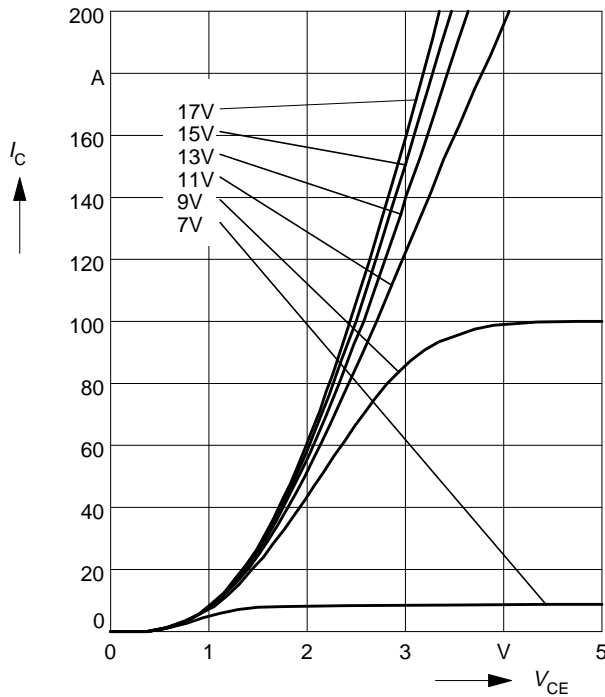

Typ. output characteristics

$$I_C = f(V_{CE})$$

parameter: $t_p = 80 \mu s$, $T_j = 125 \text{ }^\circ\text{C}$

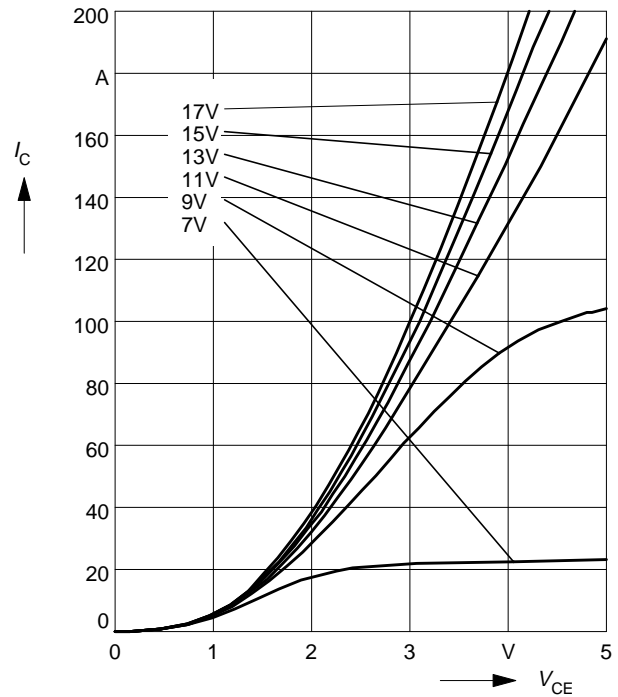

Typ. transfer characteristics

$$I_C = f(V_{GE})$$

parameter: $t_p = 80 \mu s$, $V_{CE} = 20 \text{ V}$

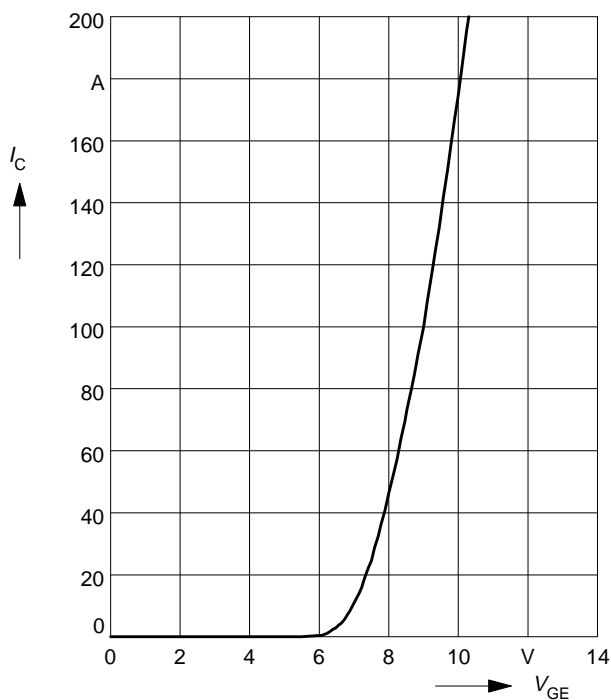

Typ. gate charge

$$V_{GE} = f(Q_{Gate})$$

parameter: $I_{C\ puls} = 100\ A$

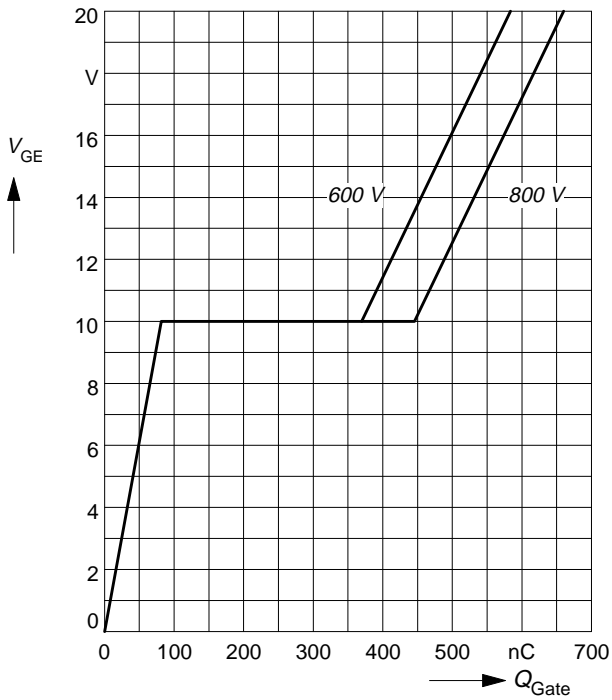

Typ. capacitances

$$C = f(V_{CE})$$

parameter: $V_{GE} = 0\ V, f = 1\ MHz$

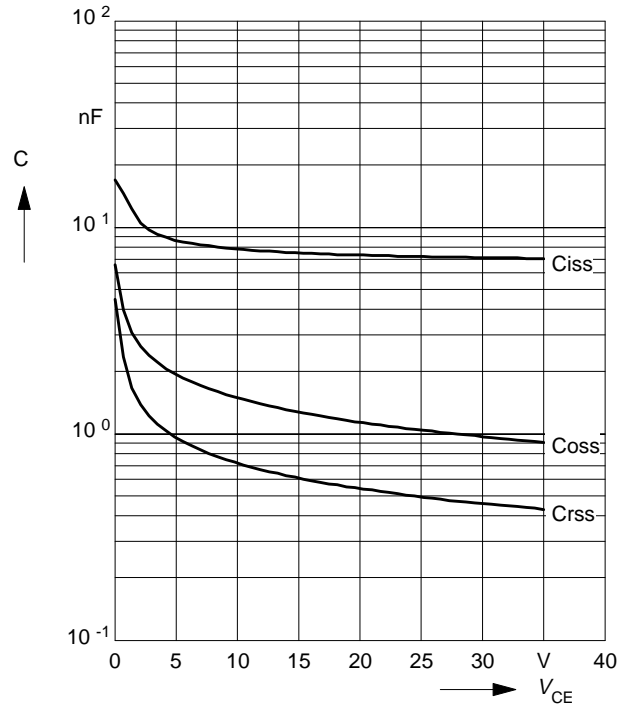

Reverse biased safe operating area

$$I_{C\ puls} = f(V_{CE}), T_j = 150^\circ C$$

parameter: $V_{GE} = 15\ V$



Short circuit safe operating area

$$I_{C\ sc} = f(V_{CE}), T_j = 150^\circ C$$

parameter: $V_{GE} = \pm 15\ V, t_{SC} \le 10\ \mu s, L < 50\ nH$



Typ. switching time

$t = f(I_C)$, inductive load, $T_j = 125^\circ\text{C}$
 par.: $V_{CE} = 600\text{ V}$, $V_{GE} = \pm 15\text{ V}$, $R_G = 6.8\ \Omega$

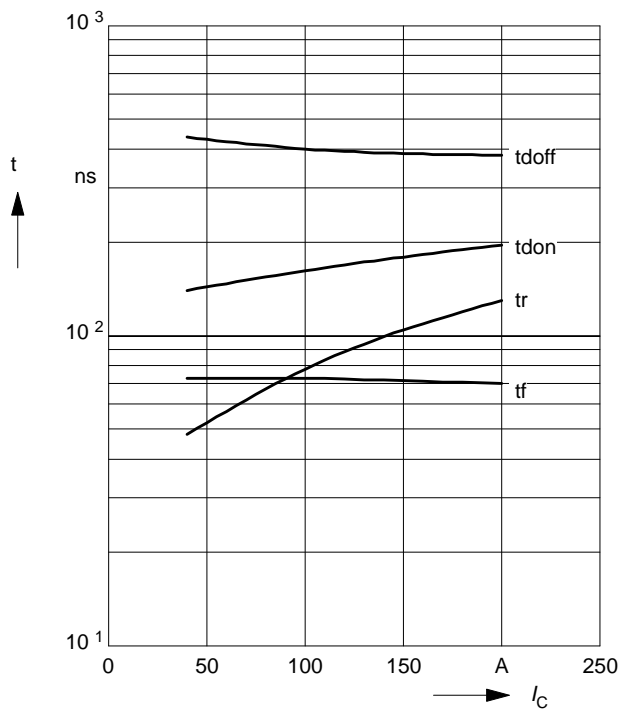

Typ. switching time

$t = f(R_G)$, inductive load, $T_j = 125^\circ\text{C}$
 par.: $V_{CE} = 600\text{ V}$, $V_{GE} = \pm 15\text{ V}$, $I_C = 100\text{ A}$

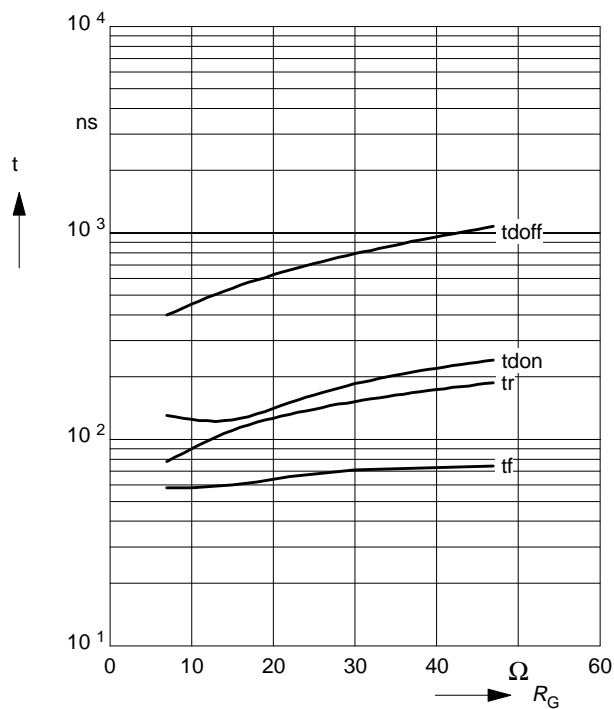

Typ. switching losses

$E = f(I_C)$, inductive load, $T_j = 125^\circ\text{C}$
 par.: $V_{CE} = 600\text{ V}$, $V_{GE} = \pm 15\text{ V}$, $R_G = 6.8\ \Omega$

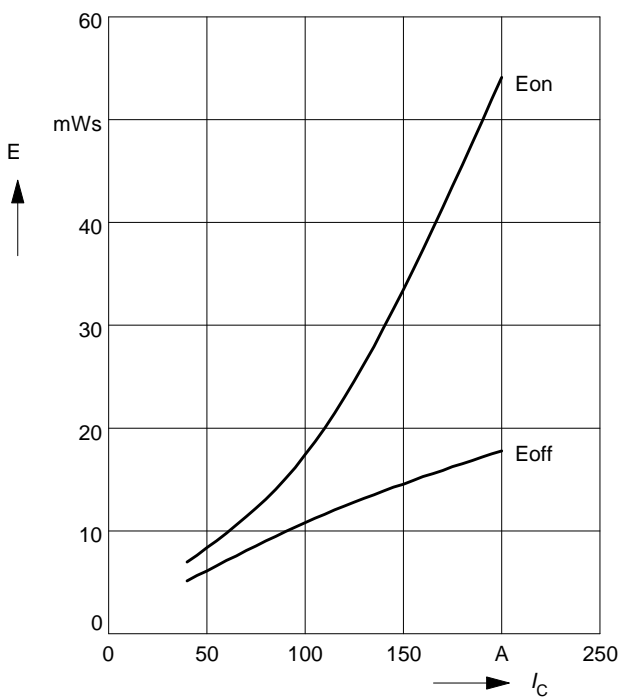

Typ. switching losses

$E = f(R_G)$, inductive load, $T_j = 125^\circ\text{C}$
 par.: $V_{CE} = 600\text{ V}$, $V_{GE} = \pm 15\text{ V}$, $I_C = 100\text{ A}$

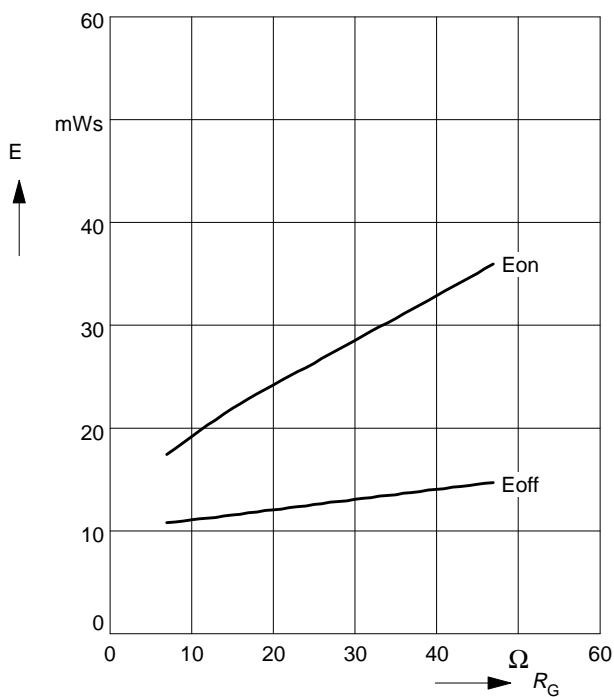

Forward characteristics of fast recovery reverse diode $I_F = f(V_F)$

parameter: T_j

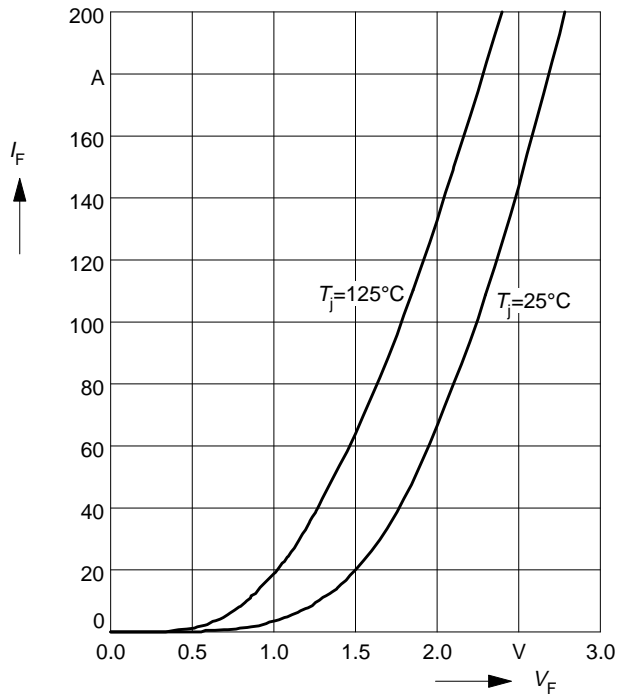

Transient thermal impedance Diode $Z_{thJC} = f(t_p)$

parameter: $D = t_p / T$

