

KA3031

6-Channel Motor Drive IC

Features

- 4-CH balanced transformerless (BTL) driver
- 2-CH (forward-reverse) control DC motor driver
- Operating supply voltage (4.5V ~ 16V)
- Built-in thermal shut down circuit (TSD)
- Built-in under voltage lockout circuit (UVLO)
- Built-in over voltage protection circuit (OVP)
- Built-in mute circuit (CH1, CH2, CH3 and CH4)
- Built-in normal op-amp
- Built-in 5V regulator with reset

Description

The KA3031 is a monolithic integrated circuit suitable for a 6-ch motor driver which drives the tracking actuator, focus actuator, sled motor, tray motor, change motor and spindle motor of the CDP/CAR-CD systems.



Typical Applications

- Compact disk player (CDP) with tray and changer
- Compact disk player (VCD) with tray and changer
- Automotive compact disk player (CDP) with tray and changer
- Mixing with compact disk player (CDP) and mini disk player (MD) with tray and changer
- Other compact disk media

Ordering Information

Device	Package	Operating Temp.
KA3031	48-QFPH-1414	-35°C ~ +85°C

Pin Assignments

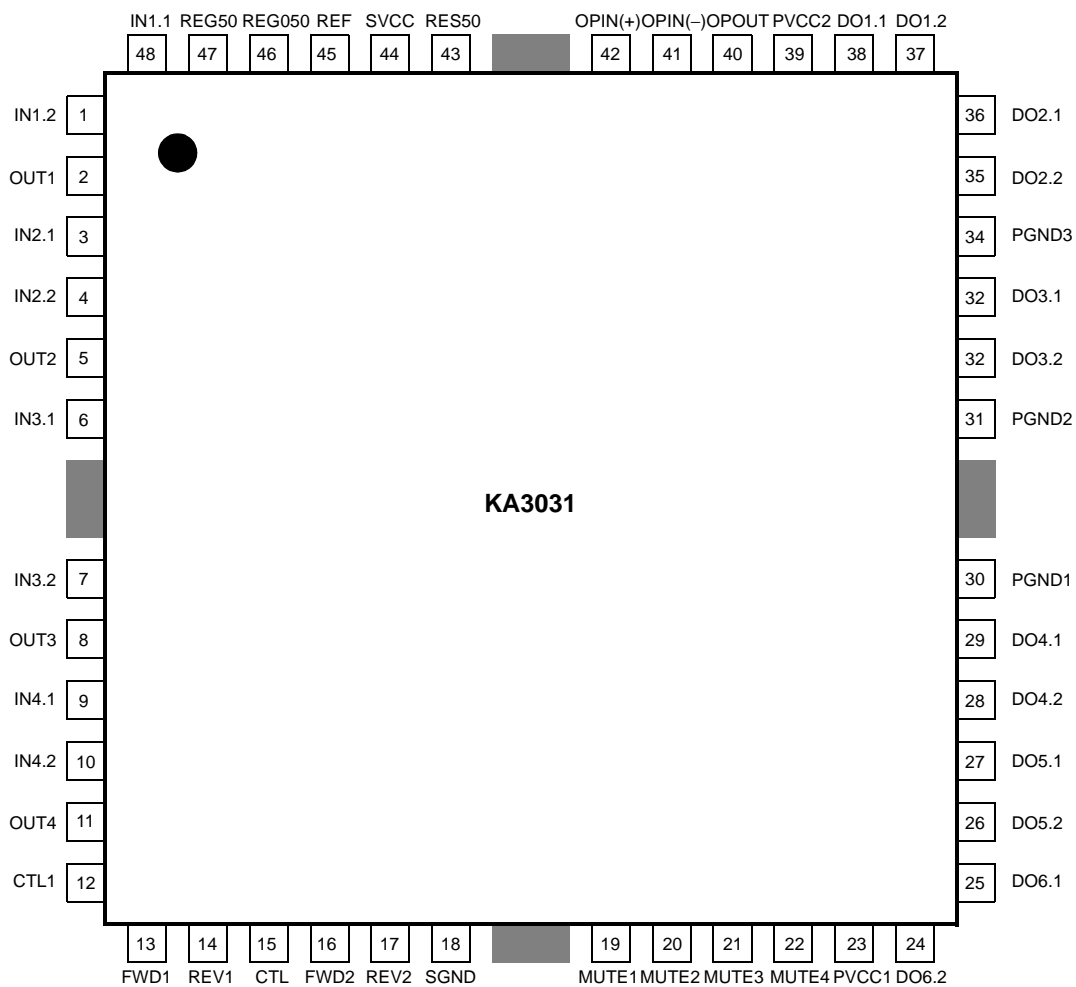

Pin Definitions

Pin Number	Pin Name	I/O	Pin Function Description
1	IN1.2	I	CH 1 op-amp input (-)
2	OUT1	O	CH 1 op-amp output
3	IN2.1	I	CH 2 op-amp input (+)
4	IN2.2	I	CH 2 op-amp input (-)
5	OUT2	O	CH 2 op-amp output
6	IN3.1	I	CH 3 op-amp input (+)
7	IN3.2	I	CH 3 op-amp input (-)
8	OUT3	O	CH 3 op-amp output
9	IN4.1	I	CH 4 op-amp input (+)
10	IN4.2	I	CH 4 op-amp input (-)
11	OUT4	O	CH 4 op-amp output
12	CTL1	I	CH 5 motor speed control
13	FWD1	I	CH 5 forward input
14	REW1	I	CH 5 reverse input
15	CTL2	I	CH 6 motor speed control
16	FWD2	I	CH 6 forward input
17	REW2	I	CH 6 reverse input
18	SGND	-	Signal ground
19	MUTE1	I	CH 1 mute
20	MUTE2	I	CH 2 mute
21	MUTE3	I	CH 3 mute
22	MUTE4	I	CH 4 mute
23	PVCC1	-	Power supply voltage (For CH 5, CH 6)
24	DO6.2	O	CH 6 drive output
25	DO6.1	O	CH 6 drive output
26	DO5.2	O	CH 5 drive output
27	DO5.1	O	CH 5 drive output
28	DO4.2	O	CH 4 drive output
29	DO4.1	O	CH 4 drive output
30	PGND	-	Power ground
31	PGND	-	Power ground
32	DO3.2	O	CH 3 drive output
33	DO3.1	O	CH 3 drive output
34	PGND	-	Power ground
35	DO2.2	O	CH 2 drive output
36	DO2.1	O	CH 2 drive output
37	DO1.2	O	CH 1 drive output
38	DO1.1	O	CH 1 drive output
39	PVCC2	-	Power supply voltage (For CH 1, CH 2, CH 3, CH 4)

Pin Definitions (Continued)

Pin Number	Pin Name	I/O	Pin Function Description
40	OPOUT	O	Opamp output
41	OPIN(-)	I	Opamp input (-)
42	OPIN(+)	I	Opamp input (+)
43	RES50	I	Regulator 5V reset
44	SVCC	-	Signal supply voltage
45	REF	I	Bias voltage input
46	REG050	O	Regulator 5V output
47	REG50	O	Regulator output
48	IN1.1	I	CH 1 opamp input (+)

Internal Block Diagram

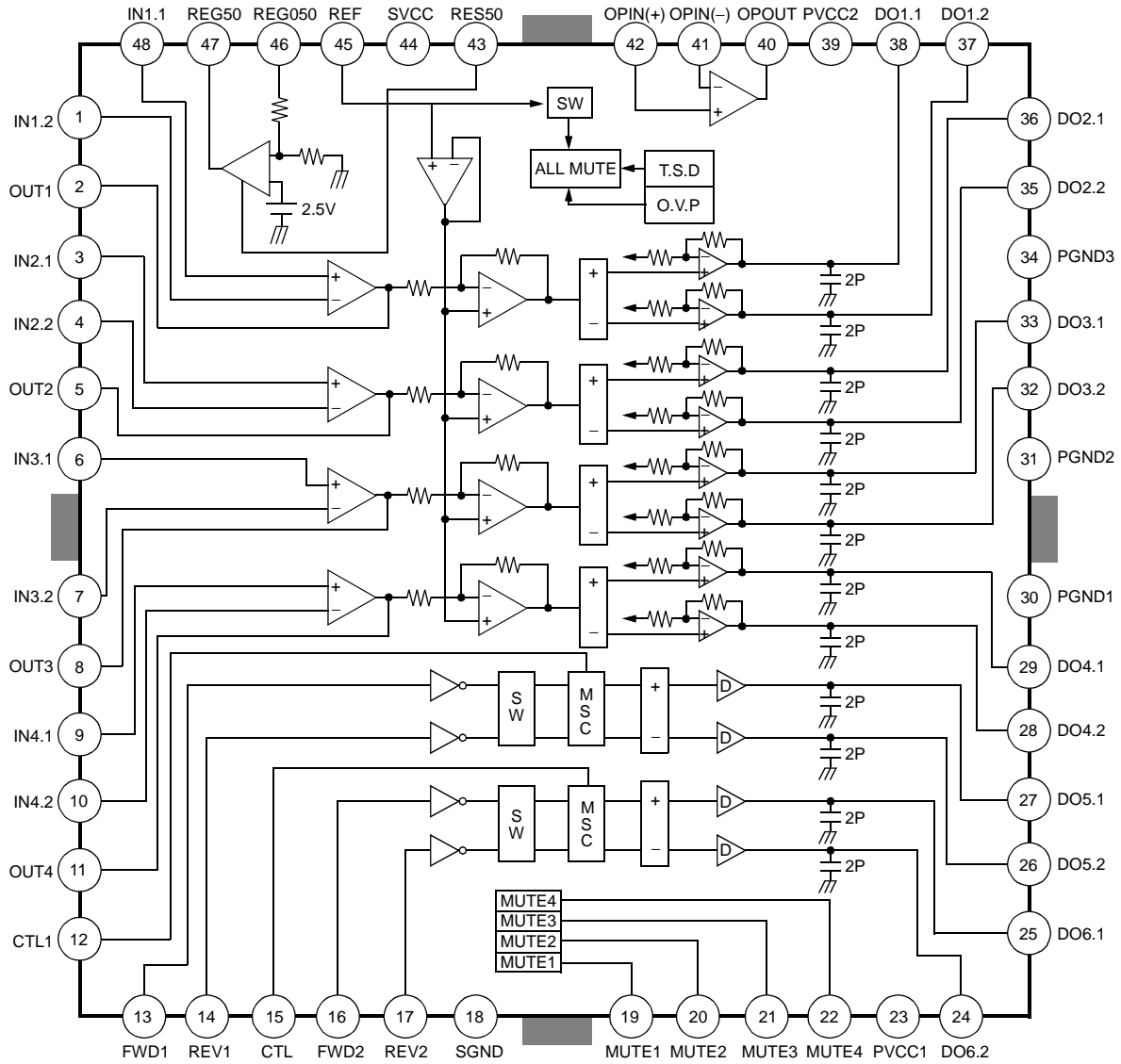

Notes:

1. SW = Logic switch
2. MSC = Motor speed control
3. D = Output driver

Equivalent Circuits

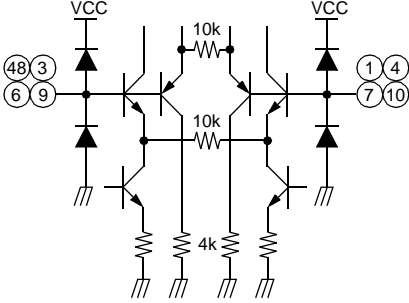
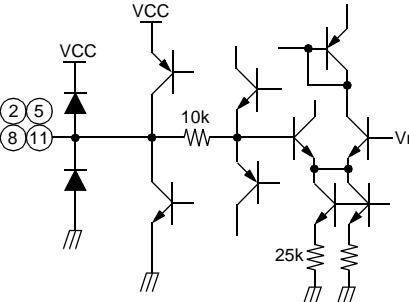
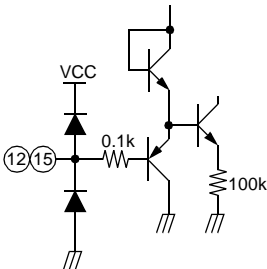
Description	Pin No.	Internal circuit
Input OPIN (+) OPIN (-)	48, 3, 6, 9 1, 4, 7, 10	
Input opout	2, 5, 8, 11	
CTL	12, 15	

Equivalent Circuits (Continued)

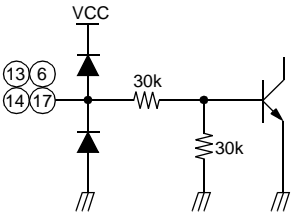
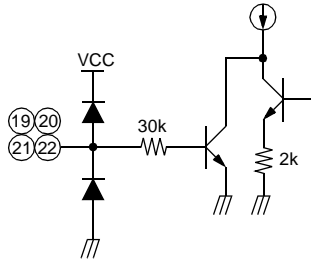
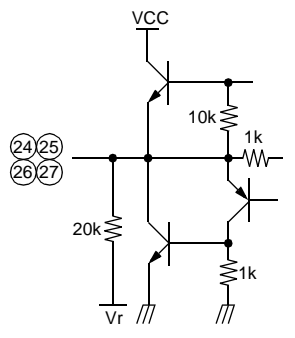
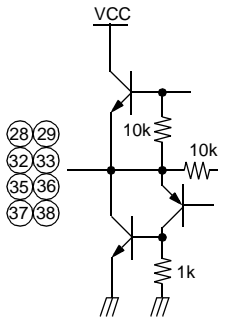
Description	Pin No.	Internal circuit
Logic drive FWD input REV input	13, 16 14, 17	
CH mute	19, 20 21, 22	
Logic drive output	24, 25 26, 27	
4-CH drive output	28, 29 32, 33 35, 36 37, 38	

Equivalent Circuits (Continued)

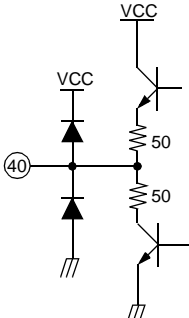
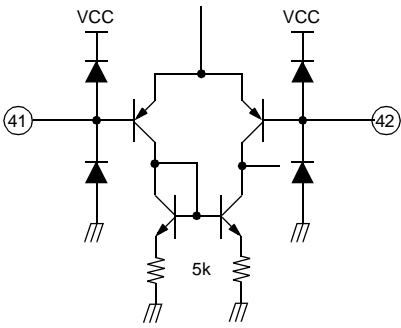
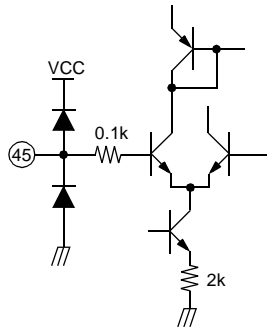
Description	Pin No.	Internal circuit
Normal opout	40	
Normal OPIN(+) OPIN(-)	42 41	
Ref	45	

Equivalent Circuits (Continued)

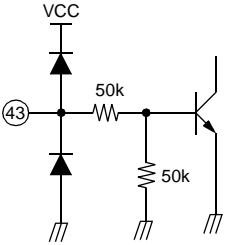
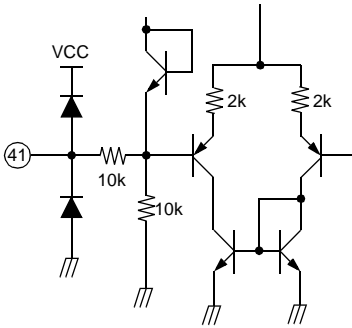
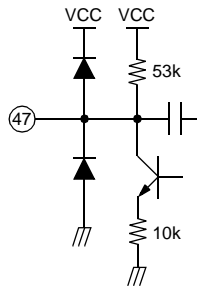
Description	Pin No.	Internal circuit
RES50	43	
REG050	46	
REG50	47	

Absolute Maximum Ratings (Ta = 25°C)

Parameter	Symbol	Value	Unit
Maximum supply voltage	VCC	18	V
Power dissipation	PD	3 ^{note}	W
Operating temperature	TOPR	-35 ~ +85	°C
Storage temperature	TSTG	-55 ~ +150	°C
Maximum output current	IOMAX	1	A

NOTE:

1. When mounted on 70mm × 70mm × 1.6mm PCB.
2. Power dissipation reduces 16mW / °C for using above Ta=25°C.
3. Do not exceed Pd and SOA.

Power Dissipation Curve

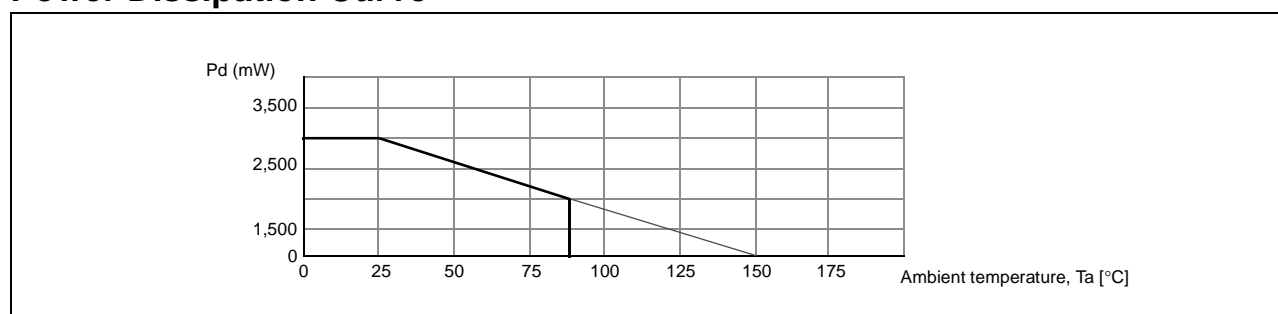

Recommended Operating Conditions (Ta = 25°C)

Parameter	Symbol	Min.	Typ.	Max.	Unit
Operating supply voltage	VCC	4.5	-	16	V

Electrical Characteristics

($S_{VCC}=PV_{CC1}=PV_{CC2}=8V$, $T_a=25^{\circ}C$, unless otherwise specified)

Parameter	Symbol	Conditions	Min.	Typ.	Max.	Units
Quiescent circuit current	ICC	under no-load	9	12	16	mA
All mute on current	IMUTE ALL	Pin 45=GND	-	6	10	mA
All mute on voltage	VMON ALL	Pin 45=Variation	-	-	0.5	V
All mute off voltage	VMOFF ALL	Pin 45=Variation	2	-	-	V
CH mute on voltage	VMON CH	Pin 19, 20, 21, 22=Variation	2	-	-	V
CH mute off voltage	VMOFF CH	Pin 19, 20, 21, 22=Variation	-	-	0.5	V
DRIVER PART ($R_L=8\Omega$)						
Input offset voltage	VIO	-	-20	-	+20	mV
Output offset voltage	VOO	$V_{IN}=2.5V$	-50	-	+50	mV
Maximum output voltage 1	VOM1	$V_{CC}=8V$, $R_L=8\Omega$	4.0	5.5	-	V
Maximum output voltage 2	VOM2	$V_{CC}=13V$, $R_L=24\Omega$	7	9	-	V
Closed-loop voltage gain	AVF	$V_{IN}=0.1V_{RMS}$	9	10.5	12	dB
Ripple rejection ratio	RR	$V_{IN}=0.1V_{RMS}$, $f=120kHz$	-	50	-	dB
Slew rate	SR	Square, $V_{out}=2V_{p-p}$, $f=120kHz$	-	0.8	-	$V/\mu s$
NORMAL OPAMP PART						
Input offset voltage	VOF1	-	-10	-	+10	mV
Input bias current	IB1	-	-	-	300	nA
High level output voltage	VOH1	$R_L=50\Omega$	6	6.8	-	V
Low level output voltage	VOL1	$R_L=50\Omega$	-	1.0	1.8	V
Output sink current	ISINK1	$V_{IN}=-75dB$, $f=1kHz$	10	40	-	mA
Output source current	ISOURCE1	$V_{IN}=-20dB$, $f=120kHz$	10	40	-	mA
Open loop voltage gain	GVO1	Square, $V_{out}=2V_{p-p}$, $f=120kHz$	-	75	-	dB
Ripple rejection ratio	RR1	$V_{IN}=-20dB$, $f=1kHz$	-	65	-	dB
Slew rate	SR1	-	-	1	-	$V/\mu s$
Common mode rejection ratio	CMRR1	-	-	80	-	dB

Electrical Characteristics (Continued)

($V_{CC}=PV_{CC1}=PV_{CC2}=8V$, $T_a=25^{\circ}C$, unless otherwise specified)

Parameter	Symbol	Conditions	Min.	Typ.	Max.	Units
INPUT OPAMP PART						
Input offset voltage	V_{OF2}	-	-10	-	+10	mV
Input bias current	I_{B2}	-	-	-	400	nA
High level output voltage	V_{OH2}	-	7	7.7	-	V
Low level output voltage	V_{OL2}	-	-	0.2	0.5	V
Output sink current	I_{SINK2}	-	500	800	-	μA
Output source current	$I_{SOURCE2}$	-	500	800	-	μA
Open loop voltage gain	G_{VO2}	$V_{IN}=-75dB$, $f=1kHz$	-	80	-	dB
Slew rate	$SR2$	Square, $V_{out}=2V_{p-p}$, $f=120kHz$	-	1	-	$V/\mu s$
Common mode rejection ratio	$CMRR2$	$V_{IN}=-20dB$, $f=1kHz$	-	80	-	dB
5V REGULATOR PART						
Regulator output voltage	V_{reg}	$I_L=100mA$	4.75	5	5.25	V
Load regulation	ΔV_{R1}	$I_L=0 \rightarrow 200mA$	-40	0	+10	mV
Line regulation	ΔV_{CC}	$I_L=200mA$, $V_{CC}=6V \rightarrow 9V$	-20	0	+30	mV
Reset on voltage	Res_{on}	-	-	-	0.5	V
Reset off voltage	Res_{off}	-	2	-	-	V
TRAY, CHANGER DRIVER PART ($R_L=45\Omega$)						
Input high level voltage	V_{IH}	-	2	-	-	V
Input low level voltage	V_{IL}	-	-	-	0.5	V
Output voltage 1	V_{O1}	$V_{CC}=8V$, $V_{CTL}=3.5V$	5.2	6.0	6.8	V
Output voltage 2	V_{O2}	$V_{CC}=13V$, $V_{CTL}=4.5V$	7.5	8.5	9.5	V
Output load regulation	ΔV_{R1}	-	-	300	700	mV
Output offset voltage 1	V_{OO1}	$V_{IN}=5V$, $5V$	-10	-	+10	mV
Output offset voltage 2	V_{OO2}	$V_{IN}=0V$, $0V$	-10	-	+10	mV

Application Information

1. REFERENCE INPUT & ALL MUTE FUNCTION

Pin 45 (REF) can use the reference Input pin or the all mute signal input pin.

- Reference input
In the case of the reference input pin, you must keep the applied voltage range between 2[V] and 6.5[V] at $V_{CC} = 8[V]$.
- All mute input
When using the all mute function pin, applied voltage condition is as follows.

All mute on voltage	Below 0.5[V]	Mute function operation
All mute off voltage	Above 2[V]	Normal operation

2. SEPARATED CHANNEL MUTE FUNCTION

These pins are used for individual channel mute operation.

- When the mute pins (pin19, 20, 21 and 22) are high level, the mute circuits are activated so that the output circuit is muted.
- When the voltage of the mute pins (pin19, 20, 21 and 22) are low level, the mute circuit is stopped and output circuits operate normally.
- If the chip temperature rises above 175°C, then the thermal shutdown (TSD) circuit is activated and the output circuits are muted.
 - Mute 1 (pin 19)-CH1 mute control input pin.
 - Mute 2 (pin 20)-CH2 mute control input pin.
 - Mute 3 (pin 21)-CH3 mute control input pin.
 - Mute 4 (pin 22)-CH4 mute control input pin.

3. PROTECTION FUNCTION

- Thermal shutdown (TSD)
If the chip temperature rises above 175°C, then the thermal shutdown (TSD) circuit is activated and the output circuit is will be mute. The TSD circuit is temperature hysteresis 25°C.
- Under voltage lockout (UVLO) and over voltage protection (OVP)
It is designed to mute-operate the internal bias by the function of UVLO and OVP, when the power supply voltage falls below 3.5[V] or above 20[V].

4. REGULATOR & RESET FUNCTION

The regulator and reset circuits are as illustrated in Figure 1.
where $R1=R2$.

- The external circuit is composed of the transistor, KSB772 and a capacitor, about $33[\mu\text{F}]$. The capacitor is used as a ripple eliminator and should have good temperature characteristics.
- The regulator output voltage (pin 46) is decided as follows.
 $V_{out} = 2 \times 2.5 = 5[\text{V}]$ (where $R1 = R2$)
- When the voltage of pin 43 (V_{reset}) is at $5[\text{V}]$, the regulator output voltage (pin 46) because $5[\text{V}]$. If the voltage of pin 43 is $0[\text{V}]$, the output voltage of pin 46 because $0[\text{V}]$.

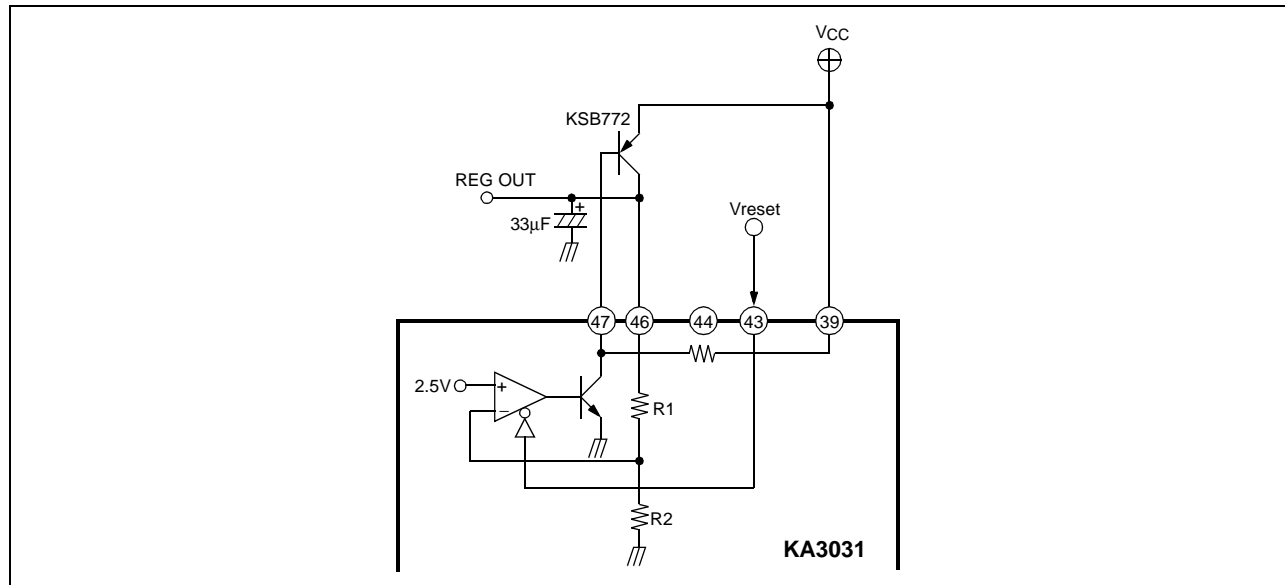
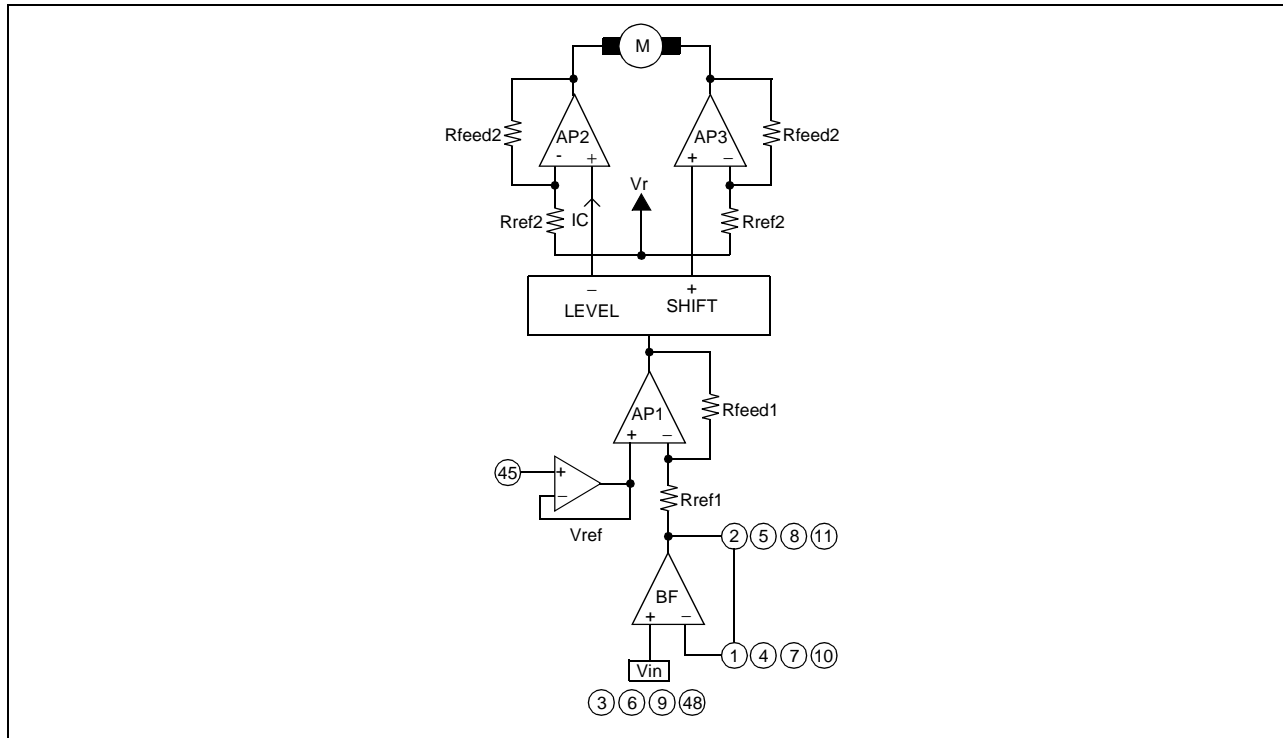

Figure 1. Regulator circuit

5. FOCUS, TRACKING ACTUATOR, SPINDLE, SLED MOTOR DRIVE PART



- The voltage, V_{ref} is the reference voltage given by the external bias voltage of the pin 45.
- The input signal (V_{in}) through pins 3, 6, 9 and 48 is amplified one times ($R_{ref1} = R_{feed1}$) by the AP1 and then fed to the level shift.
- The level shift produces the current due to the difference between the input signal and the arbitrary reference signal. The current produced as $+\Delta I$ and $-\Delta I$ are fed into the output amplifier, where output amplifier (AP2, 3) gain is two times (all $R_{ref2} = R_{feed2}$).
- If you desire to change the gain, the input buffer amplifier (BF) can be used.
- The output stage is the balanced transformerless (BTL) driver.
- The bias voltage V_r is expressed as below;

$$V_r = \frac{V_{CC} - V_{BE}}{2} [V]$$

6. TRAY, CHANGE MOTOR DRIVE PART

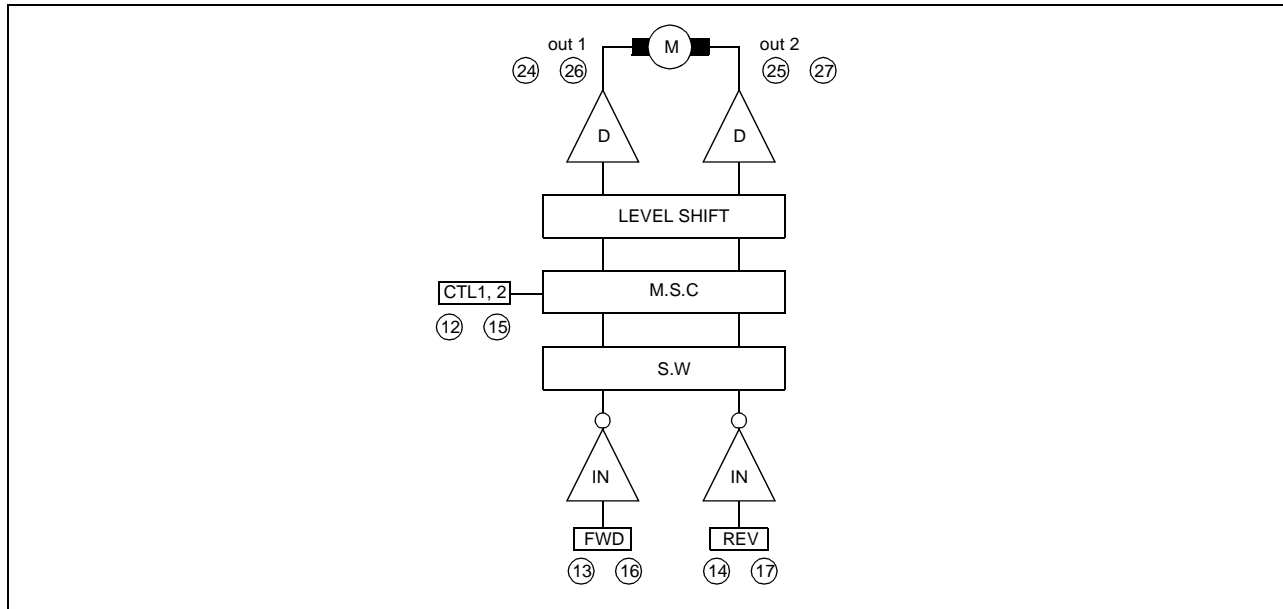

- Rotational direction control

The forward and reverse rotational direction is controlled by FWD (pin 13, 16) and REV (pin 14, 17) input conditions are as follows.

INPUT		OUTPUT		
FWD	REV	OUT 1	OUT 2	State
H	H	Vr	Vr	Brake
H	L	H	L	Forward
L	H	L	H	Reverse
L	L	Vr	Vr	Brake

- where Vr is $(V_{cc} - V_{be}) / 2 = 3.65V$ (at $V_{cc}=8V$)
- where Out1 pins are pins 24 and 26, and out2 pins are pins 25 and 27
- Motor speed control
 - The almost maximum torque is obtained when it is used with the pins 12 and 15 (CTL1, 2) open.
 - If the torque of the motor is too low, then the applied voltage at pins 12 and 15 (CTL1, 2) are 0[V].
 - When motor speed controlled, the applied voltage of the pins 12 and 15 (CTL1, 2) is between 0 and 4V. Also, if the speed control is constant, the applied voltage of the pins 12 and 15 (CTL1, 2) is between 4 and 5V.
 - This IC's applied maximum voltage is 6V when V_{CC} is 8V.
 - You must not use the applied CTL1, 2 voltage above 5.8V when V_{CC} is 8V, and 3V when V_{CC} is 5V.

Typical Performance Characteristics

Total circuit

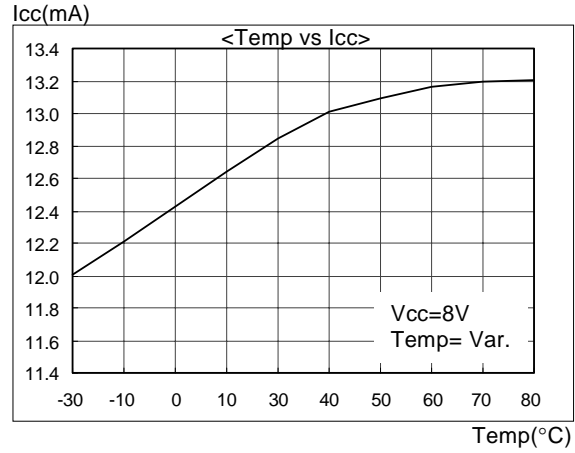
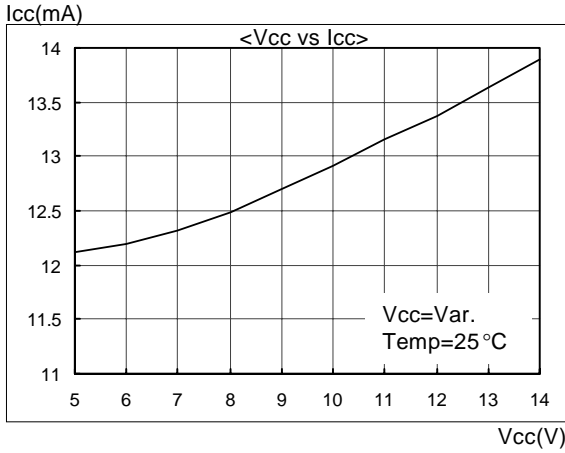

Focus, Tracking, Spindle, Sled drive part

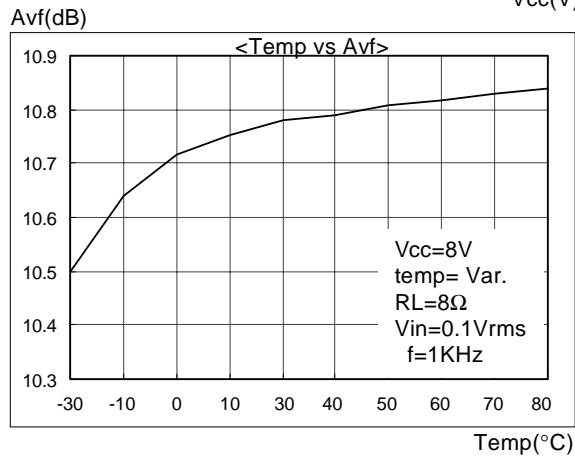
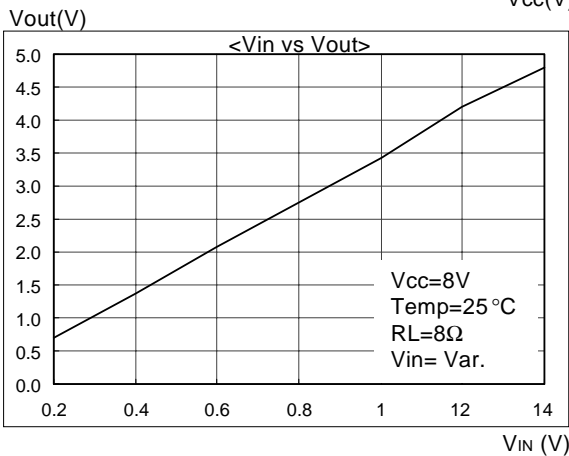
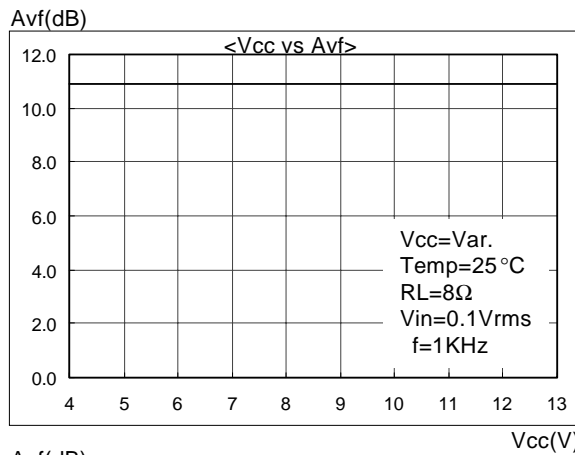
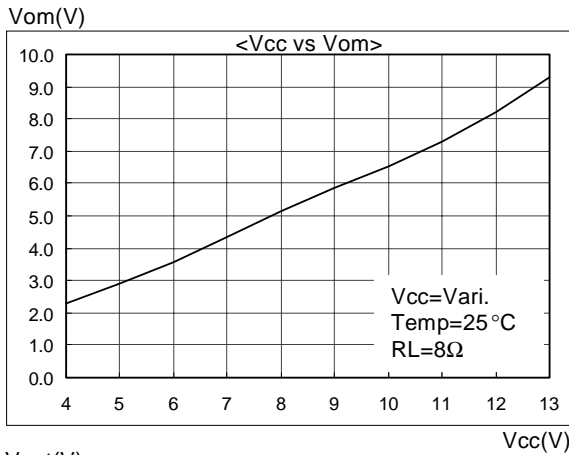

Typical Performance Characteristics (Continued)

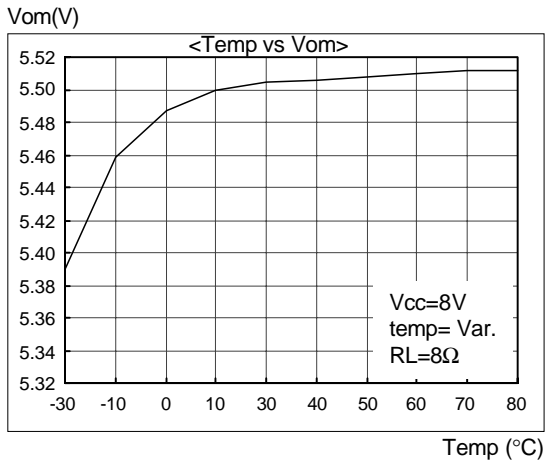

Tray, Change drive part

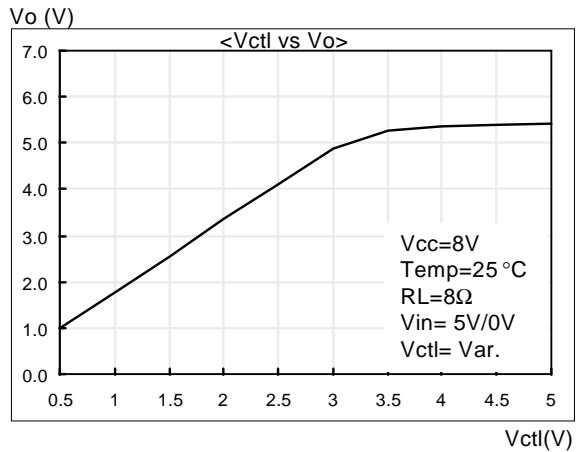
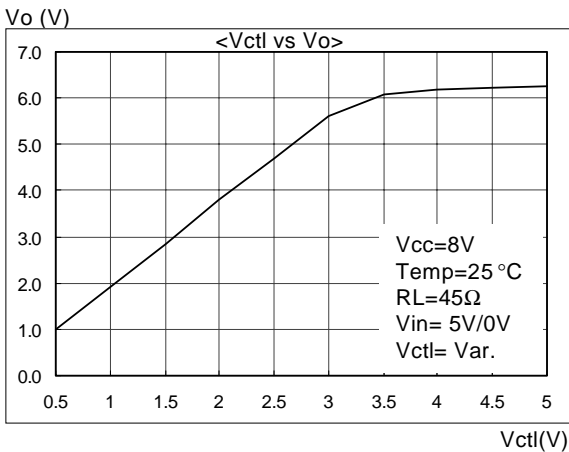
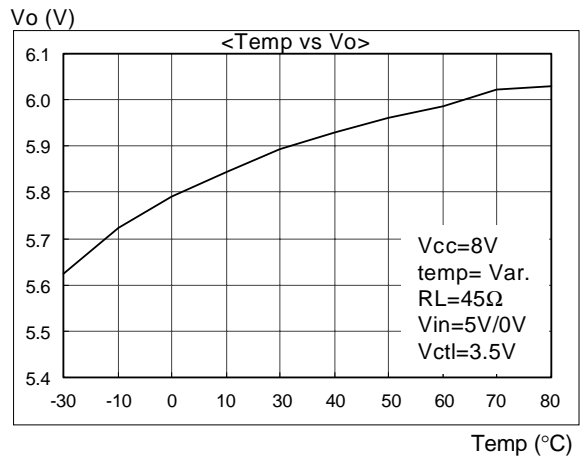
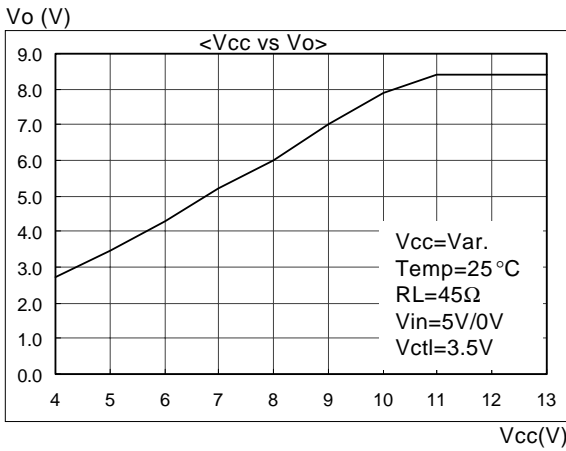

Typical Performance Characteristics (Continued)

Regulator part

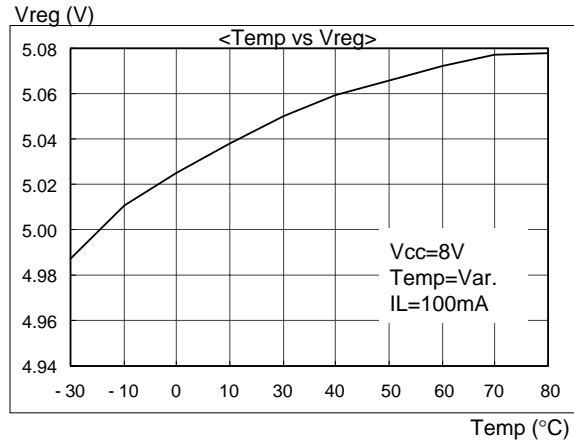
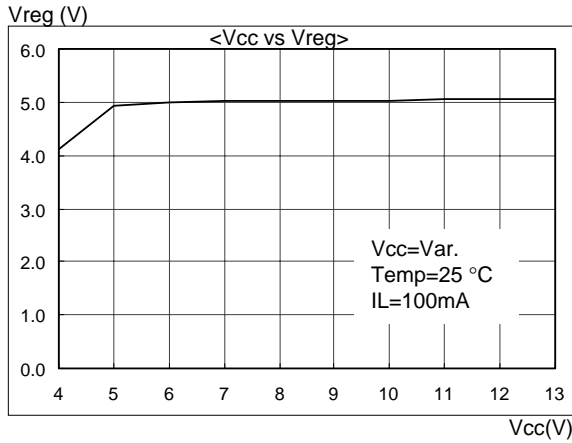

Normal Op Amp part

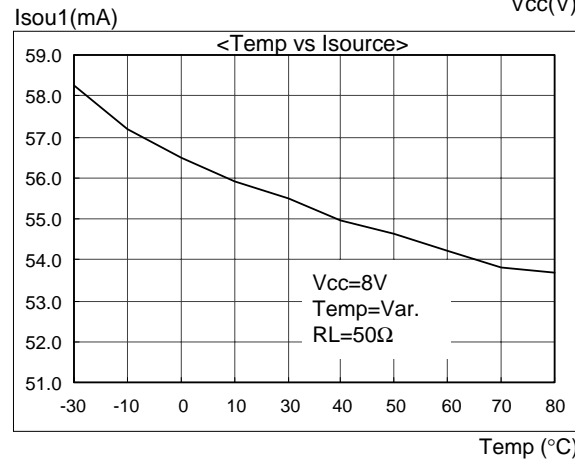
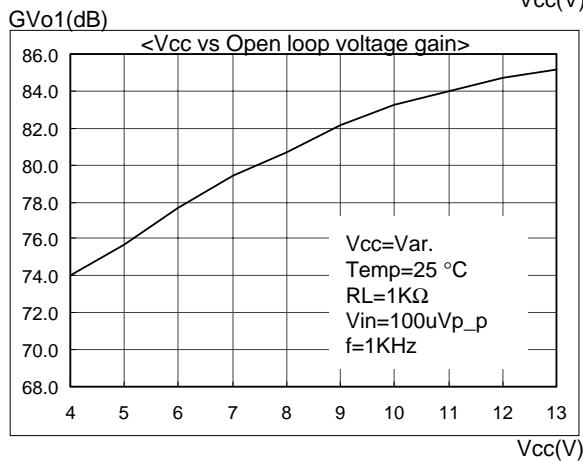
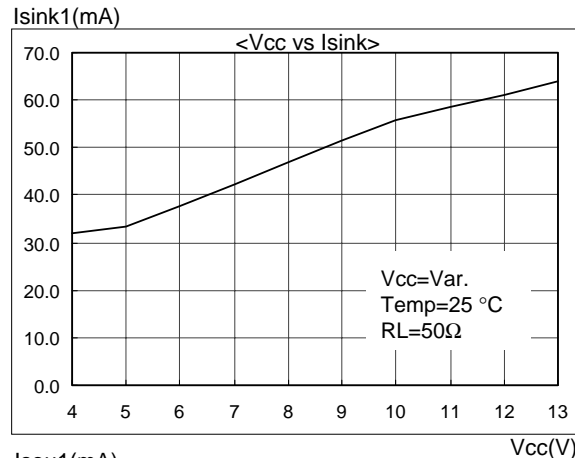
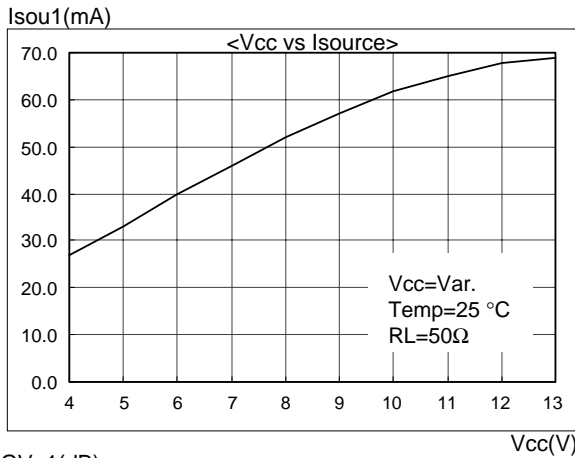

Typical Performance Characteristics (Continued)

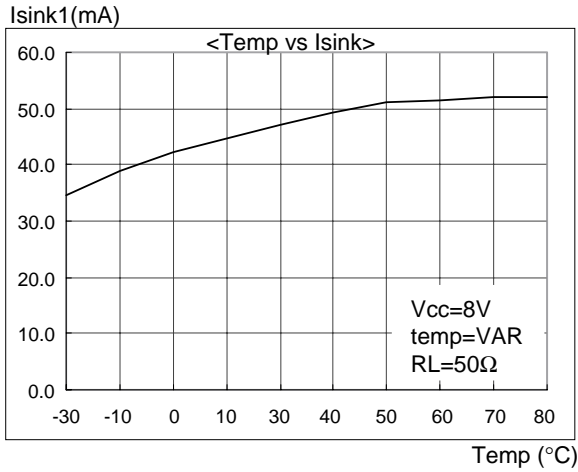

Input Op Amp part

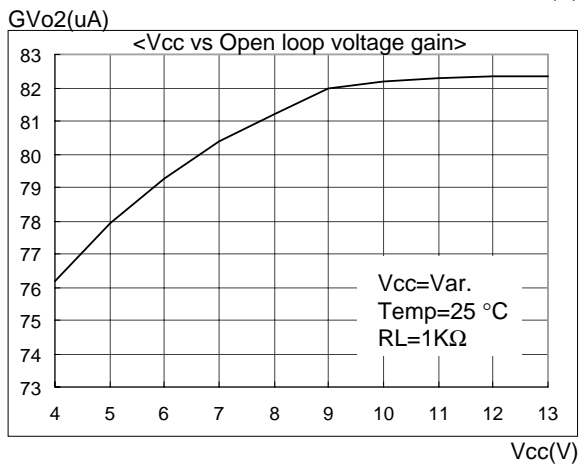
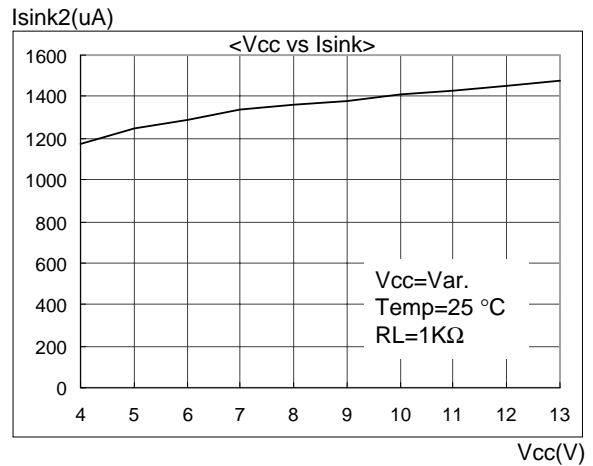
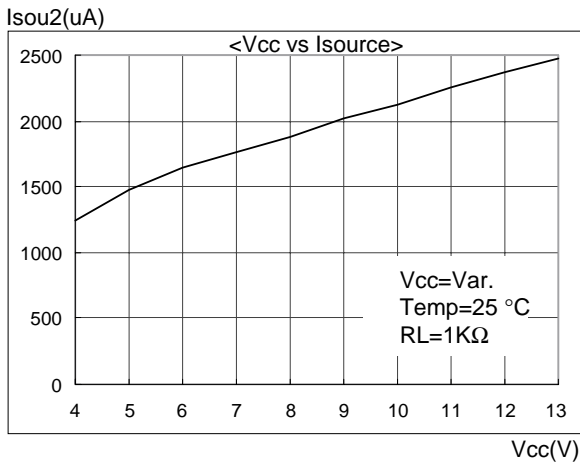

Test Circuits

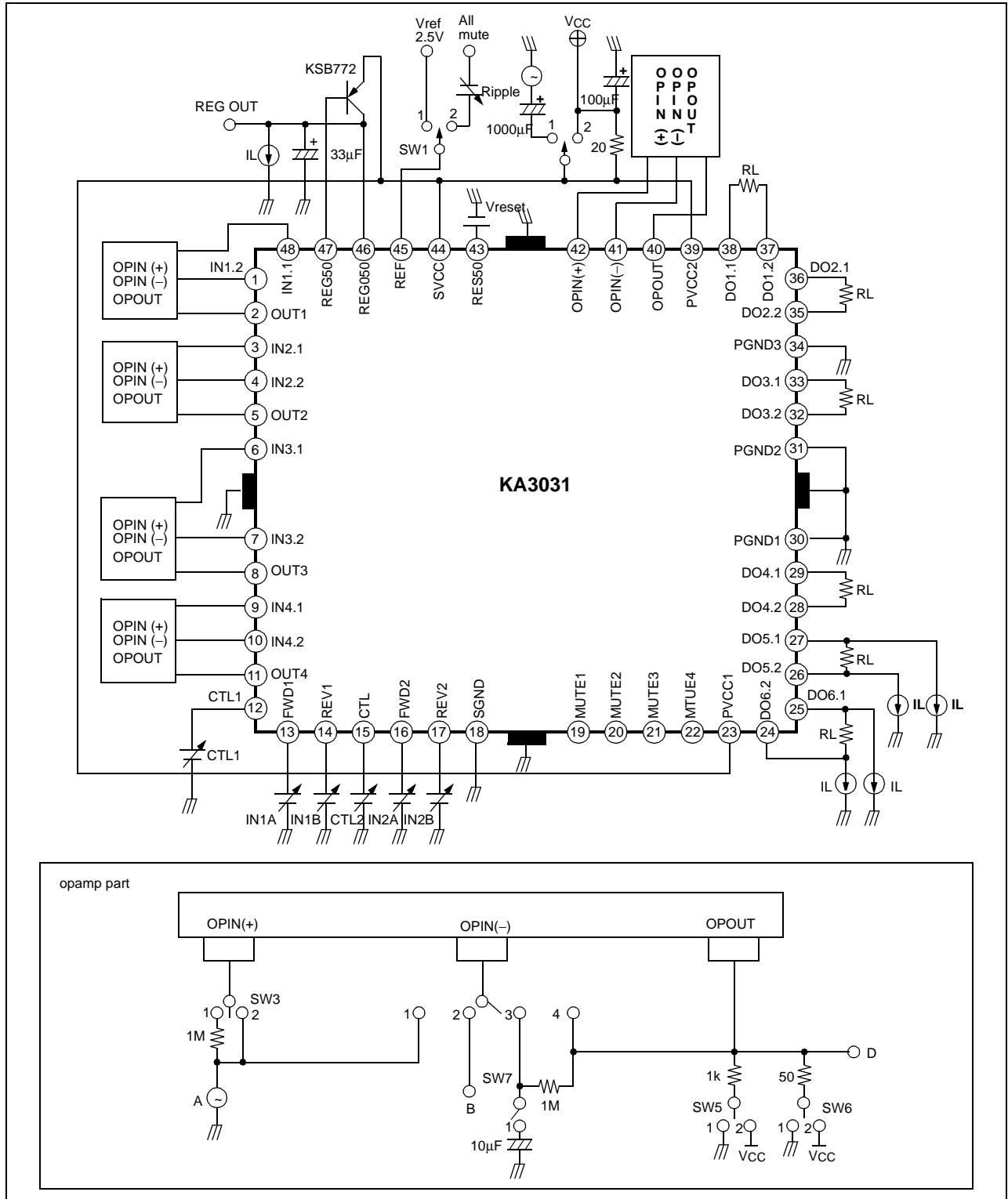

Application Circuits

Voltage Mode Control

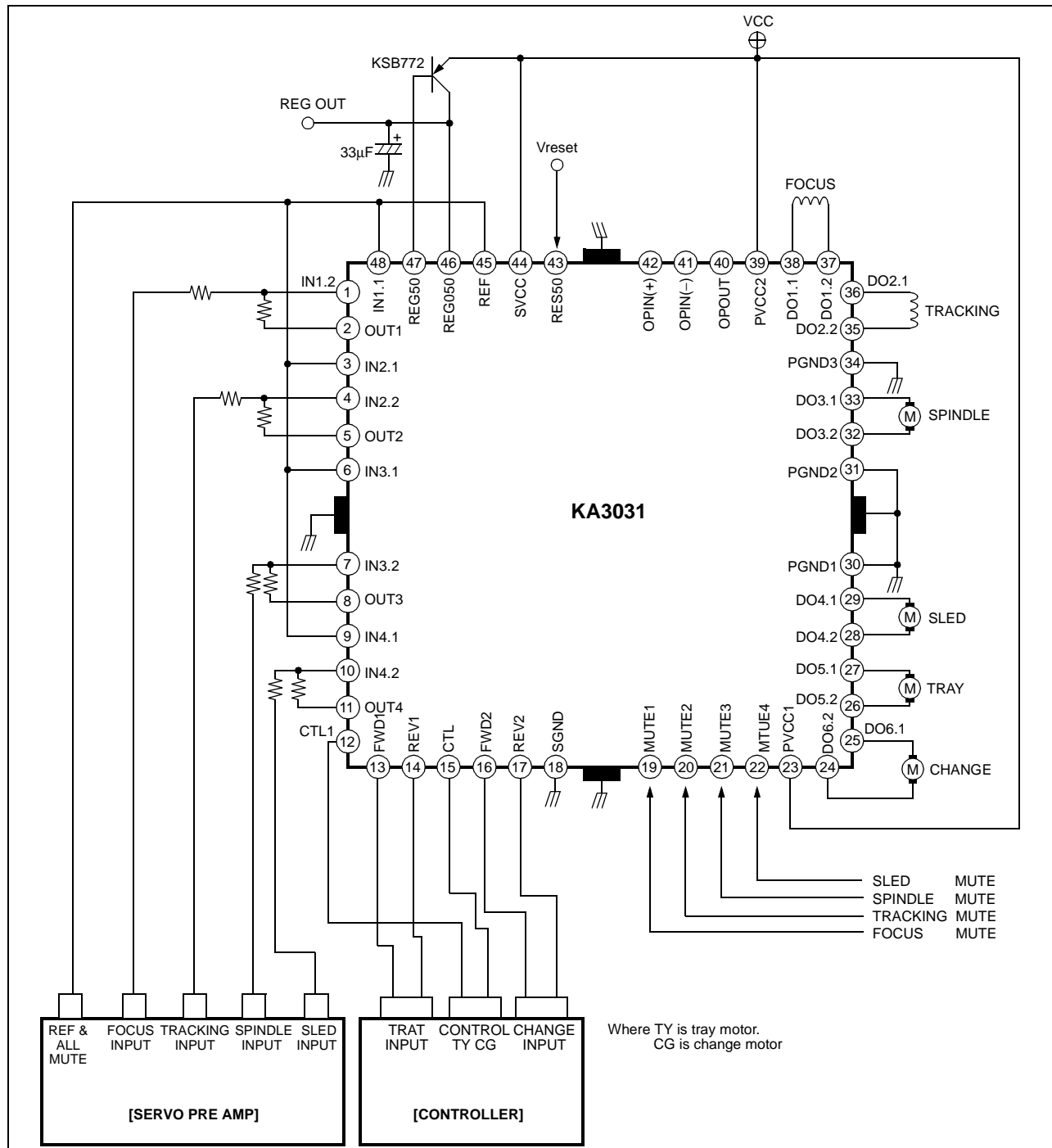

Notes:

Radiation pin is connected to the internal GND of the package.
Connect the pin to the external GND.

Application Circuits

Differential Mode Control

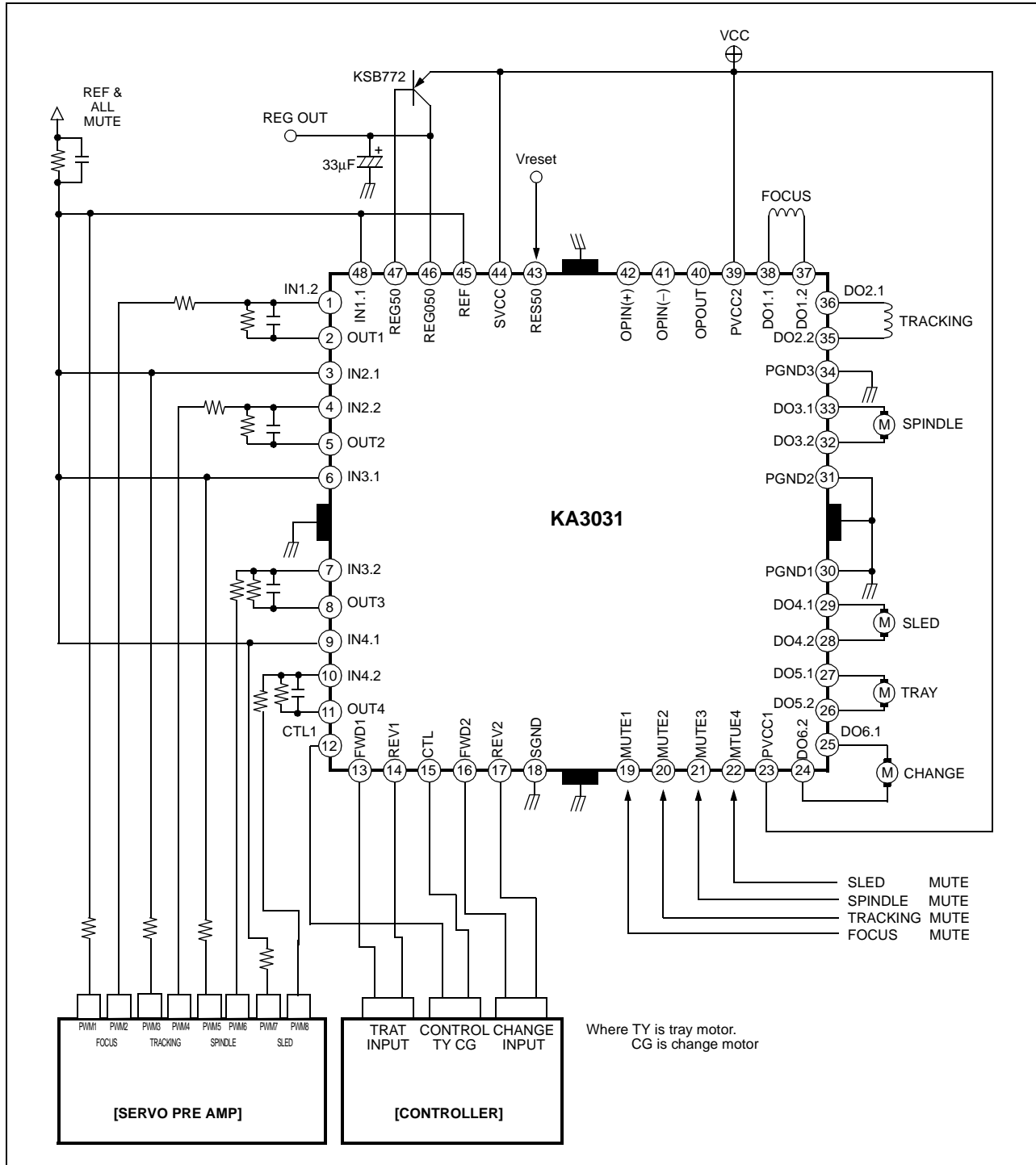

DISCLAIMER

FAIRCHILD SEMICONDUCTOR RESERVES THE RIGHT TO MAKE CHANGES WITHOUT FURTHER NOTICE TO ANY PRODUCTS HEREIN TO IMPROVE RELIABILITY, FUNCTION OR DESIGN. FAIRCHILD DOES NOT ASSUME ANY LIABILITY ARISING OUT OF THE APPLICATION OR USE OF ANY PRODUCT OR CIRCUIT DESCRIBED HEREIN; NEITHER DOES IT CONVEY ANY LICENSE UNDER ITS PATENT RIGHTS, NOR THE RIGHTS OF OTHERS.

LIFE SUPPORT POLICY

FAIRCHILD'S PRODUCTS ARE NOT AUTHORIZED FOR USE AS CRITICAL COMPONENTS IN LIFE SUPPORT DEVICES OR SYSTEMS WITHOUT THE EXPRESS WRITTEN APPROVAL OF THE PRESIDENT OF FAIRCHILD SEMICONDUCTOR INTERNATIONAL. As used herein:

1. Life support devices or systems are devices or systems which, (a) are intended for surgical implant into the body, or (b) support or sustain life, and (c) whose failure to perform when properly used in accordance with instructions for use provided in the labeling, can be reasonably expected to result in a significant injury of the user.
2. A critical component in any component of a life support device or system whose failure to perform can be reasonably expected to cause the failure of the life support device or system, or to affect its safety or effectiveness.