

## 3A HIGH-SPEED MOSFET DRIVERS

### FEATURES

- Latch-Up Protected: Will Withstand 500mA Reverse Current
- Input Will Withstand Negative Inputs Up to 5V
- ESD Protected ..... 4kV
- High Peak Output Current ..... 3A
- Wide Operating Range ..... 4.5V to 16V
- High Capacitive Load Drive Capability ..... 180 pF in 20nsec
- Short Delay Time ..... 35nsec Typ
- Consistent Delay Times With Changes in Supply Voltage
- Matched Delay Times
- Low Supply Current
  - With Logic “1” Input ..... 50µA
  - With Logic “0” Input ..... 150µA
- Low Output Impedance ..... 2.7Ω
- Pinout Same as TC1410/11/12

### GENERAL DESCRIPTION

The TC1413/1413N are 3A CMOS buffer/drivers. They will not latch up under any conditions within their power and voltage ratings. They are not subject to damage when up to 5V of noise spiking of either polarity that occurs on the ground pin. They can accept, without damage or logic upset, up to 500 mA of current of either polarity being forced back into their output. All terminals are fully protected against up to 4 kV of electrostatic discharge.

As MOSFET drivers, the TC1413/1413N can easily switch 1800pF gate capacitance in 20 ns with matched rise and fall times, and provide low enough impedance in both the ON and the OFF states to ensure the MOSFET's intended state will not be affected, even by large transients. The rise and fall time edges are matched to allow driving short-duration inputs with greater output accuracy.

**4**

### PIN CONFIGURATIONS

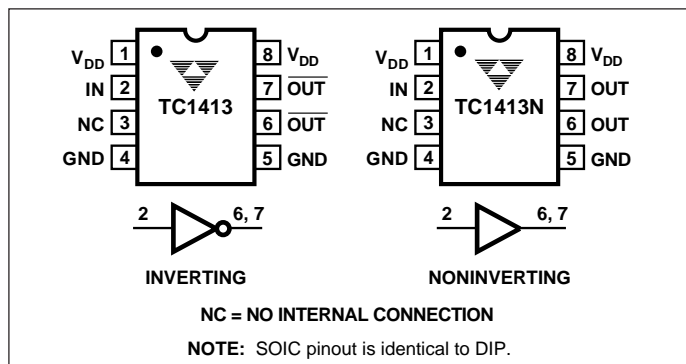

### ORDERING INFORMATION

Part No.	Package	Temp. Range
TC1413COA	8-Pin SOIC	0°C to +70°C
TC1413CPA	8-Pin Plastic DIP	0°C to +70°C
TC1413EOA	8-Pin SOIC	-40°C to +85°C
TC1413EPA	8-Pin Plastic DIP	-40°C to +85°C
TC1413NCOA	8-Pin SOIC	0°C to +70°C
TC1413NCPA	8-Pin Plastic DIP	0°C to +70°C
TC1413NEOA	8-Pin SOIC	-40°C to +85°C
TC1413NEPA	8-Pin Plastic DIP	-40°C to +85°C

### FUNCTIONAL BLOCK DIAGRAM

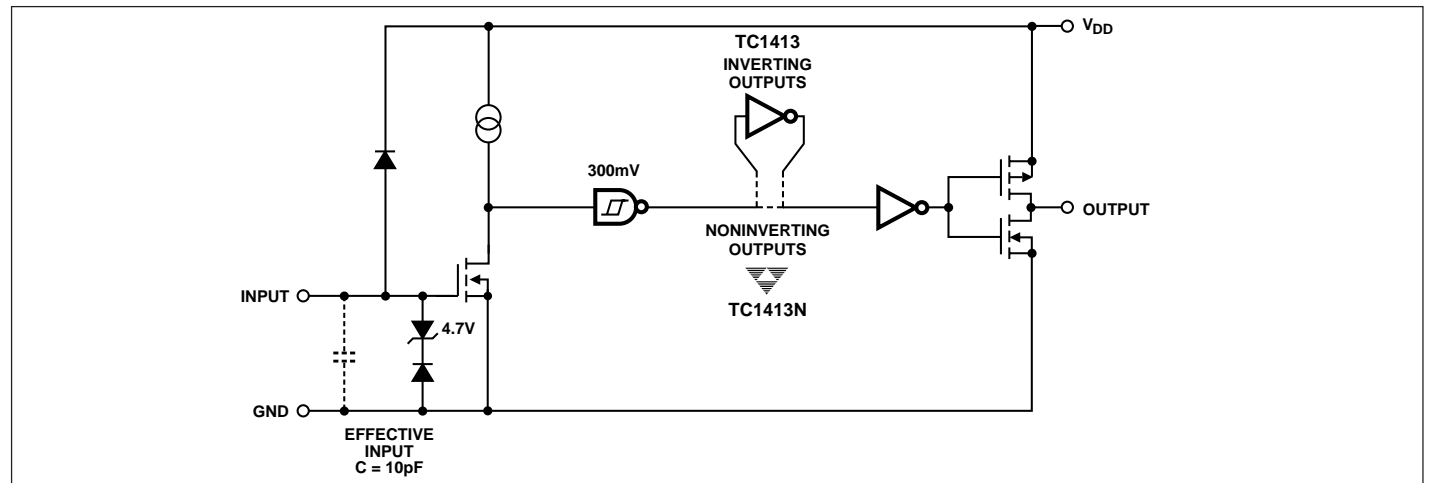

## TC1413 TC1413N

### ABSOLUTE MAXIMUM RATINGS\*

Supply Voltage .....	+20V
Input Voltage, IN A or IN B ..( $V_{DD} + 0.3V$ ) to (GND – 5.0V)	
Maximum Chip Temperature .....	+150°C
Storage Temperature Range .....	– 65°C to +150°C
Lead Temperature (Soldering, 10 sec) .....	+300°C
Package Thermal Resistance	
CerDIP $R_{\theta J-A}$ .....	150°C/W
CerDIP $R_{\theta J-C}$ .....	50°C/W
PDIP $R_{\theta J-A}$ .....	125°C/W
PDIP $R_{\theta J-C}$ .....	42°C/W
SOIC $R_{\theta J-A}$ .....	155°C/W
SOIC $R_{\theta J-C}$ .....	45°C/W

### Operating Temperature Range

C Version .....	0°C to +70°C
E Version .....	– 40°C to +85°C
Power Dissipation ( $T_A \leq 70^\circ\text{C}$ )	
Plastic .....	730mW
CerDIP .....	800mW
SOIC .....	470mW

\*Static-sensitive device. Unused devices must be stored in conductive material. Protect devices from static discharge and static fields. Stresses above those listed under "Absolute Maximum Ratings" may cause permanent damage to the device. These are stress ratings only and functional operation of the device at these or any other conditions above those indicated in the operation sections of the specifications is not implied. Exposure to absolute maximum rating conditions for extended periods may affect device reliability.

**ELECTRICAL CHARACTERISTICS:** Over operating temperature range with  $4.5V \leq V_{DD} \leq 16V$ , unless otherwise specified. Typical values are measured at  $T_A = 25^\circ\text{C}$ ;  $V_{DD} = 16V$ .

Symbol	Parameter	Test Conditions	Min	Typ	Max	Unit
<b>Input</b>						
$V_{IH}$	Logic 1 High Input Voltage		2.0	—	—	V
$V_{IL}$	Logic 0 Low Input Voltage		—	—	0.8	V
$I_{IN}$	Input Current	$-5V \leq V_{IN} \leq V_{DD}$ $T_A = 25^\circ\text{C}$ $-40^\circ\text{C} \leq T_A \leq 85^\circ\text{C}$	– 1 – 10	—	1 10	$\mu\text{A}$
<b>Output</b>						
$V_{OH}$	High Output Voltage	DC Test	$V_{DD} - 0.025$	—	—	V
$V_{OL}$	Low Output Voltage	DC Test	—	—	0.025	V
$R_O$	Output Resistance	$V_{DD} = 16V, I_O = 10\text{ mA}$ $T_A = 25^\circ\text{C}$ $0^\circ\text{C} \leq T_A \leq 70^\circ\text{C}$ $-40^\circ\text{C} \leq T_A \leq 85^\circ\text{C}$	— — —	2.7 3.3 3.3	4 5 5	$\Omega$
$I_{PK}$	Peak Output Current	$V_{DD} = 16V$	—	3.0	—	A
$I_{REV}$	Latch-Up Protection Withstand Reverse Current	Duty Cycle $\leq 2\%$ $t \leq 300\ \mu\text{sec}$ $V_{DD} = 16V$	0.5	—	—	A
<b>Switching Time (Note 1)</b>						
$t_R$	Rise Time	Figure 1 $T_A = 25^\circ\text{C}$ $0^\circ\text{C} \leq T_A \leq 70^\circ\text{C}$ $-40^\circ\text{C} \leq T_A \leq 85^\circ\text{C}$	— — —	20 22 24	28 33 33	nsec
$t_F$	Fall Time	Figure 1 $T_A = 25^\circ\text{C}$ $0^\circ\text{C} \leq T_A \leq 70^\circ\text{C}$ $-40^\circ\text{C} \leq T_A \leq 85^\circ\text{C}$	— — —	20 22 24	28 33 33	nsec
$t_{D1}$	Delay Time	Figure 1 $T_A = 25^\circ\text{C}$ $0^\circ\text{C} \leq T_A \leq 70^\circ\text{C}$ $-40^\circ\text{C} \leq T_A \leq 85^\circ\text{C}$	— — —	35 40 40	45 50 50	nsec
$t_{D2}$	Delay Time	Figure 1 $T_A = 25^\circ\text{C}$ $0^\circ\text{C} \leq T_A \leq 70^\circ\text{C}$ $-40^\circ\text{C} \leq T_A \leq 85^\circ\text{C}$	— — —	35 40 40	45 50 50	nsec
<b>Power Supply</b>						
$I_S$	Power Supply Current	$V_{IN} = 3V$ $V_{IN} = 0V$ $V_{DD} = 16V$	— —	0.5 0.1	1.0 0.15	mA

**NOTE:** 1. Switching times are guaranteed by design.

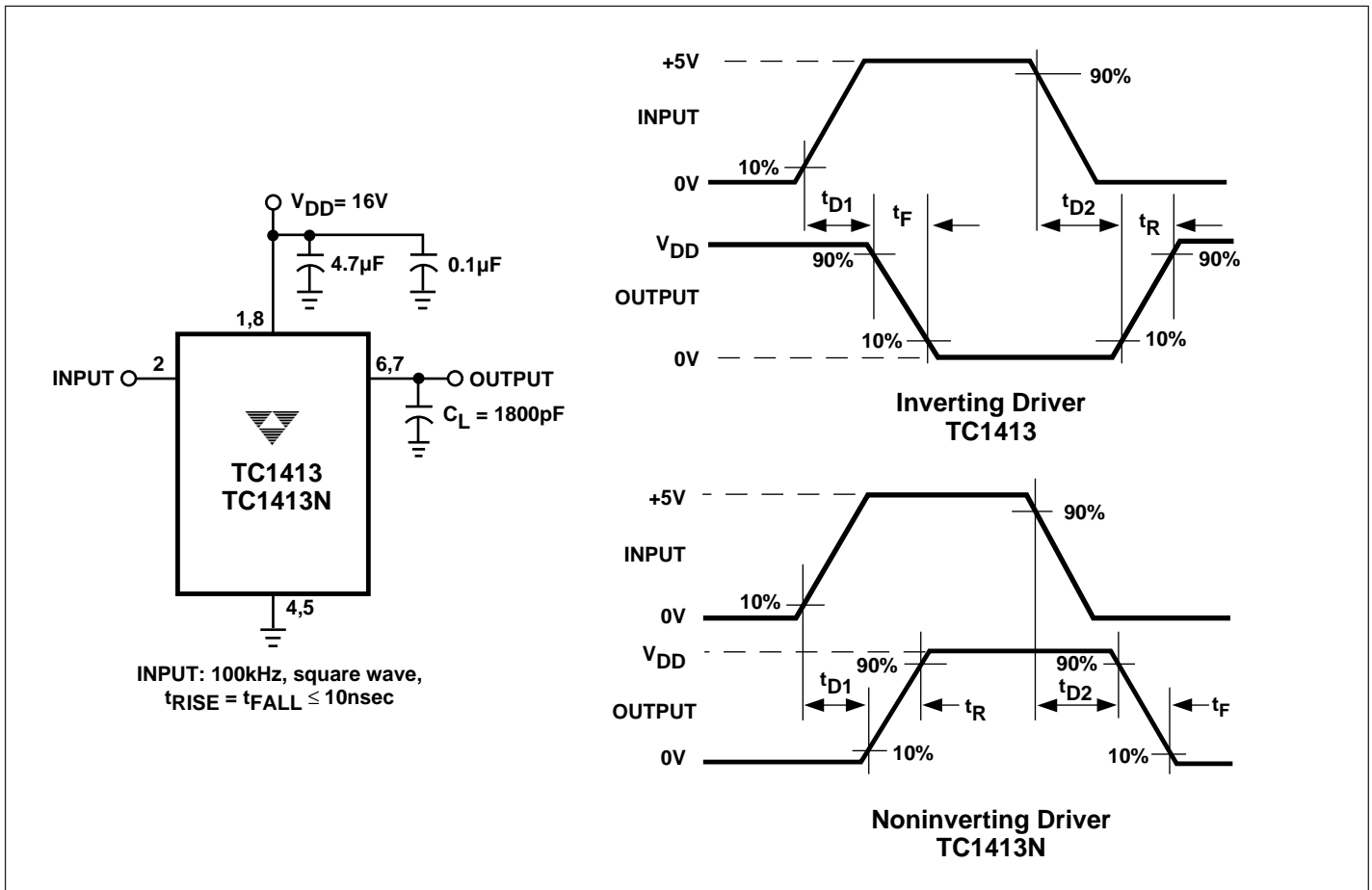
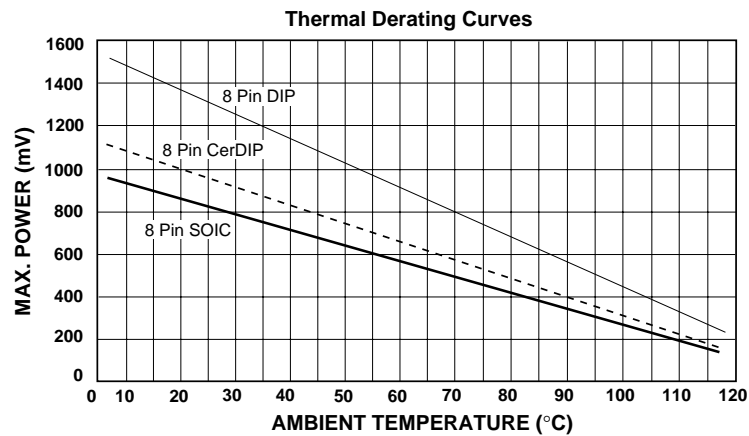

Figure 1. Switching Time Test Circuit



TC1413  
TC1413N

## TYPICAL CHARACTERISTICS

**Quiescent Supply Current vs. Supply Voltage**  
 $T_A = 25^\circ\text{C}$

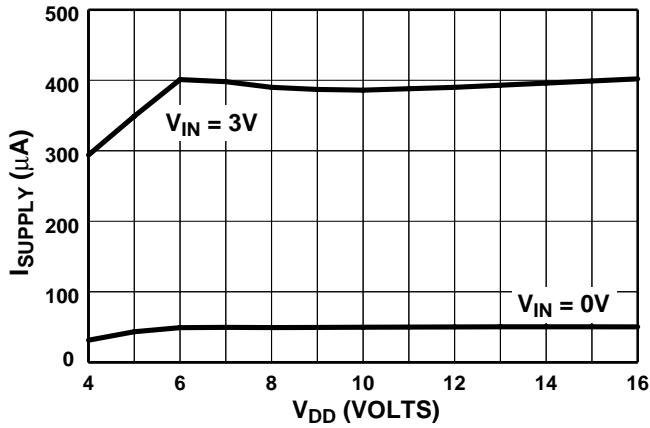

**Quiescent Supply Current vs. Temperature**  
 $V_{\text{SUPPLY}} = 16\text{V}$

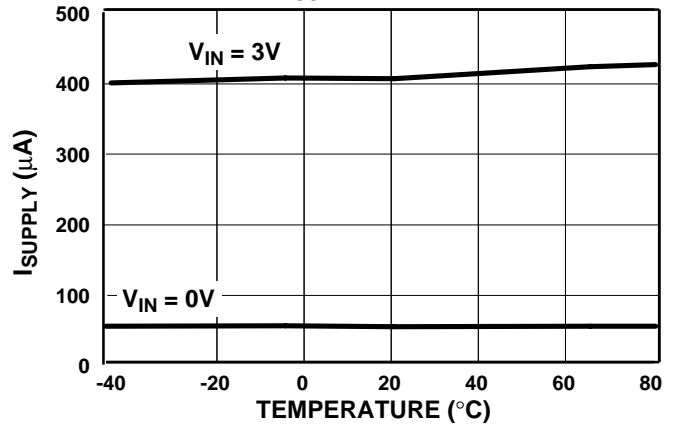

**Input Threshold vs. Supply Voltage**  
 $T_A = 25^\circ\text{C}$

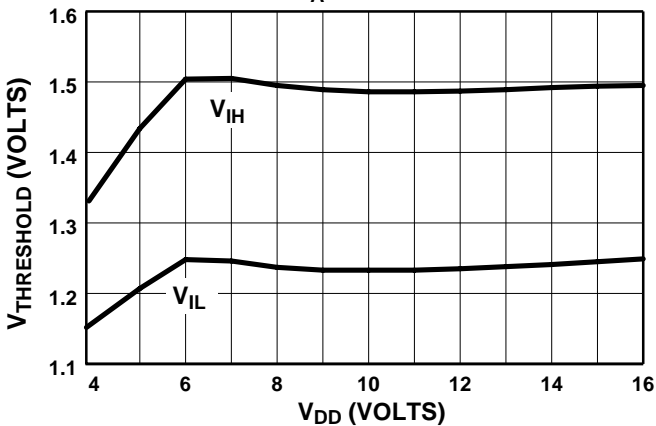

**Input Threshold vs. Temperature**  
 $V_{\text{SUPPLY}} = 16\text{V}$

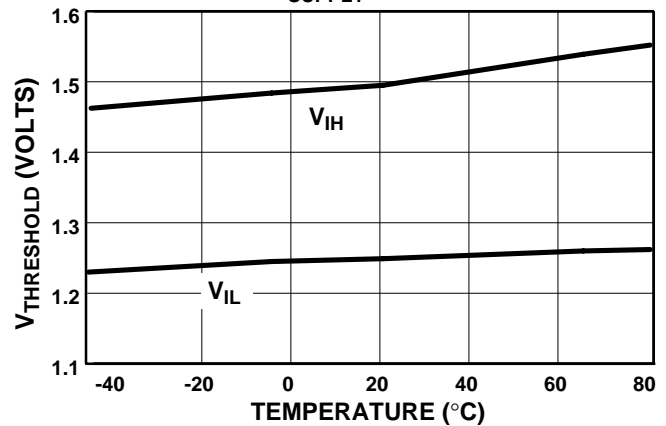

**High-State Output Resistance**

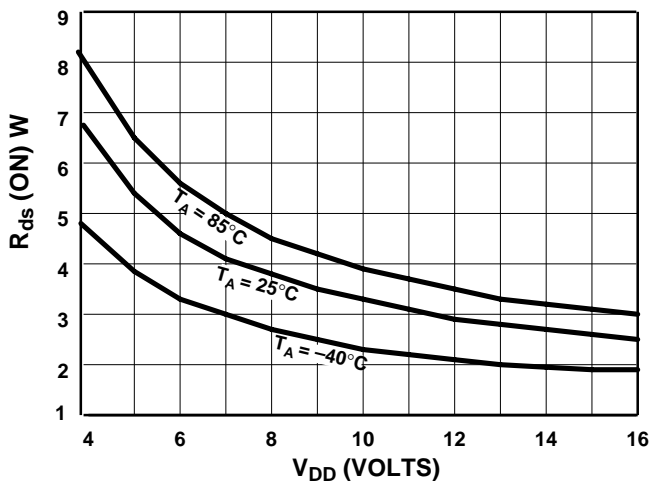

**Low-State Output Resistance**

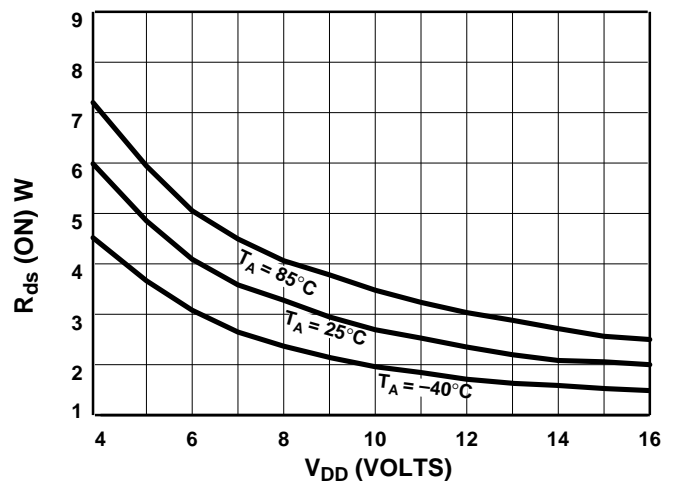

## TYPICAL CHARACTERISTICS (Cont.)

**Rise Time vs. Supply Voltage**  
 $C_{LOAD} = 1800pF$

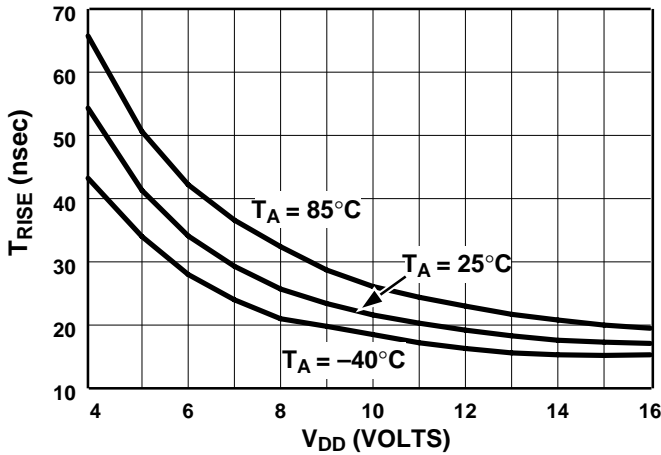

**Fall Time vs. Supply Voltage**  
 $C_{LOAD} = 1800pF$

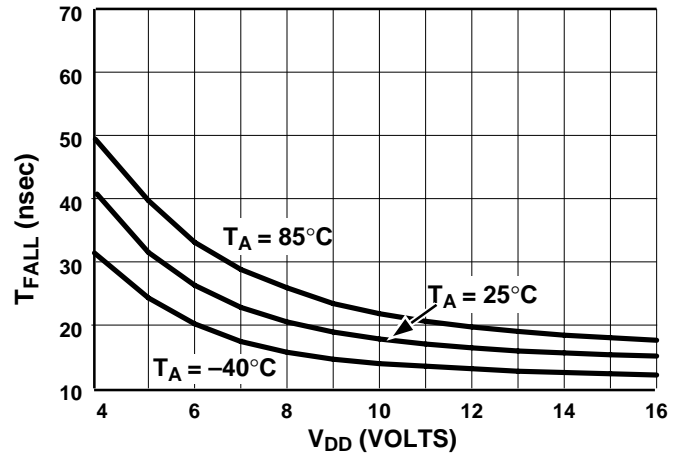

**T<sub>D1</sub> Propagation Delay vs. Supply Voltage**  
 $C_{LOAD} = 1800pF$

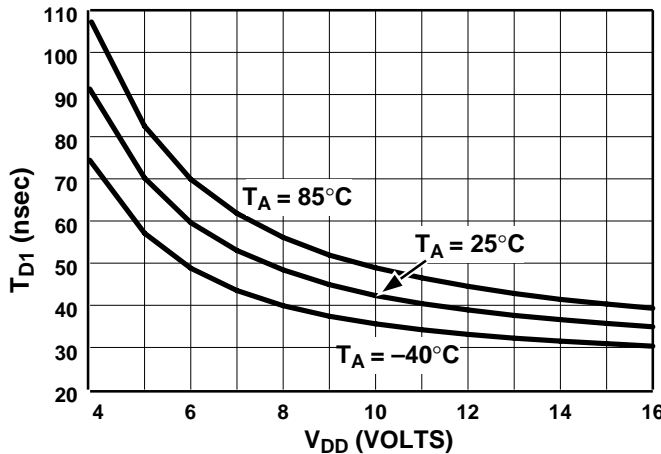

**T<sub>D2</sub> Propagation Delay vs. Supply Voltage**  
 $C_{LOAD} = 1800pF$

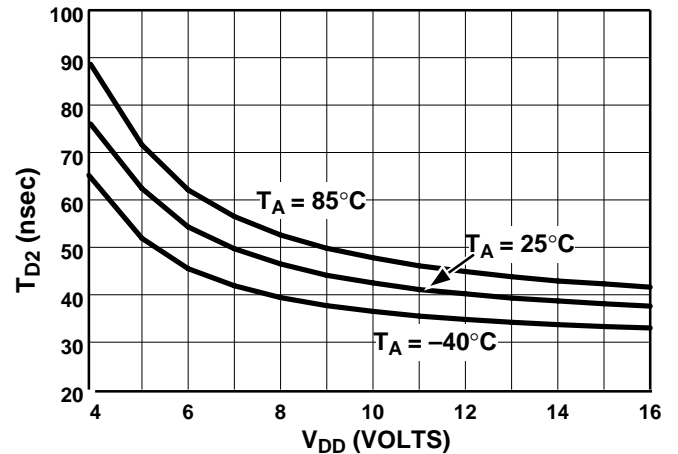

**Rise and Fall Times vs. Capacitive Load**  
 $T_A = 25^\circ C, V_{DD} = 16V$

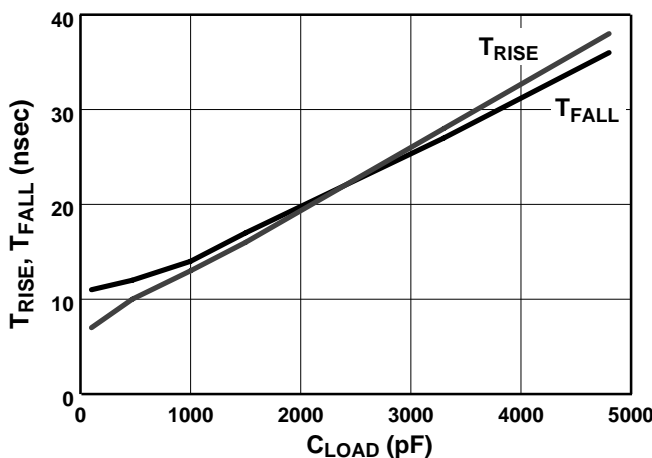

**Propagation Delays vs. Capacitive Load**  
 $T_A = 25^\circ C, V_{DD} = 16V$

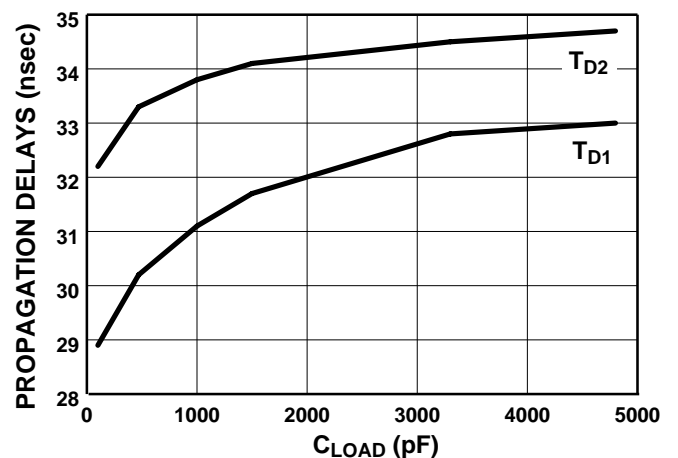

4