

# SIEMENS

# NEW

## SFH6315T SFH6316T SFH6343T HIGH SPEED OPTOCOUPLER

### FEATURES

- Surface Mountable
- Industry Standard SOIC-8 Footprint
- Compatible with Infrared Vapor Phase Reflow and Wave Soldering Processes
- Isolation Voltage, 2500 V<sub>RMS</sub>
- Very High Common Mode Transient Immunity: 15000 V/ $\mu$ s at V<sub>CM</sub>=1500 V Guaranteed (SFH6343T)
- High Speed: 1 Mb/s
- TTL Compatible
- Guaranteed AC and DC Performance Over Temperature: 0°C to 70°C
- Open Collector Output
- Pin Compatible with HP Optocouplers  
SFH6315T—HCPL0500  
SFH6316T—HCPL0501  
SFH6343T—HCPL0453
- Available in Tape and Reel (suffix T)

### APPLICATIONS

- Line Receivers
- Logic Ground Isolation
- Analog Signal Ground Isolation
- Replace Pulse Transformers

### DESCRIPTION

The SFH6315T/16T/43T, high speed optocouplers, each consists of a GaAlAs infrared emitting diode, optically coupled with an integrated photodetector and a high speed transistor. The photodetector is junction isolated from the transistor to reduce miller capacitance effects. The open collector output function allows circuit designers to adjust the load conditions when interfacing with different logic systems such as TTL, CMOS, etc.

Because the SFH6343T has a Faraday shield on the detector chip, it can also reject and minimize high input to output common mode transient voltages. There is no base connection, further reducing the potential electrical noise entering the package.

The SFH6315T/16T/43T are packaged in industry standard SOIC-8 packages and are suitable for surface mounting.

### Absolute Maximum Ratings

#### Emitter (GaAlAs)

Reverse Voltage.....	3 V
DC Forward Current.....	25 mA
Surge Forward Current.....	1 A
$t_p \leq 1 \mu$ s, 300 pulses/sec.	
Total Power Dissipation (T <sub>A</sub> ≤70°C).....	45 mW

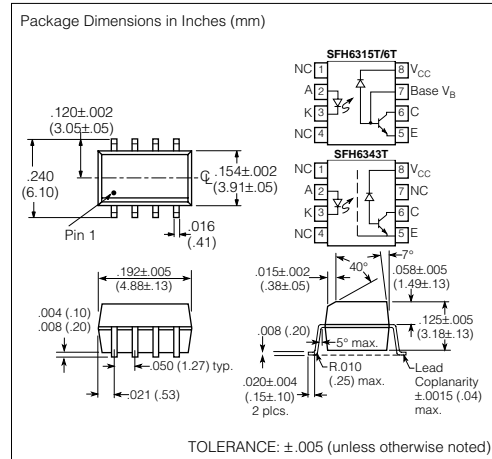

### Absolute Maximum Ratings (continued)

#### Detector (Si Photodiode + Transistor)

Supply Voltage.....	-0.5 to 30 V
Output Voltage.....	-0.5 to ≥20 V
Output Current.....	8 mA
Total Power Dissipation (T <sub>A</sub> ≤70°C).....	100 mW

#### Package

Isolation Test Voltage	
between emitter and detector.....	2500 VAC <sub>RMS</sub>
(refer to climate DIN 40046, part 2, Nov. 74)	
Pollution Degree (DIN VDE0110).....	2
Creepage.....	≥4 mm
Clearance.....	≥4 mm
Comparative Tracking Index	
per DIN IEC 112/VDE 0303, part 1.....	175
Isolation Resistance	
V <sub>IO</sub> =500 V, T <sub>A</sub> =25°C, R <sub>ISOL</sub> (Note 2).....	≥10 <sup>12</sup> Ω
V <sub>IO</sub> =500 V, T <sub>A</sub> =100°C, R <sub>ISOL</sub> (Note 2).....	≥10 <sup>11</sup> Ω
Storage Temperature Range.....	-55°C to +150°C
Ambient Temperature Range.....	-55°C to +100°C
Junction Temperature.....	100°C
Soldering Temperature (t=10 sec. max.).....	260°C
Dip soldering: distance to seating plane ≥1.5 mm	

Specifications subject to change.

### Electrical Characteristics

Over recommended temperature ( $T_A=0^{\circ}\text{C}$  to  $70^{\circ}\text{C}$ ) unless otherwise specified. See note 6. \*All typical values at  $T_A=25^{\circ}\text{C}$ .

Parameter	Symbol	Device	Min.	Typ.*	Max.	Units	Test Conditions		Note	
Input Forward Voltage	$V_F$			1.6	1.8 1.9	V	$T_A=25^{\circ}\text{C}$	$I_F=16\text{ mA}$		
Input Reverse Current	$I_R$			0.5	10	$\mu\text{A}$	$V_R=3\text{ V}$			
Input Capacitance	$C_{IN}$			75		pF	$f=1\text{ MHz}, V_F=0\text{ V}$			
Temperature Coefficient of Forward Voltage	$\frac{\Delta V_F}{\Delta T_A}$			-1.7		mV/ $^{\circ}\text{C}$	$I_F=16\text{ mA}$			
Logic Low Supply Current	$I_{CCL}$			100		$\mu\text{A}$	$I_F=16\text{ mA}, V_O=\text{Open}, V_{CC}=15\text{ V}$			
Logic High Supply Current	$I_{CCH}$			0.001	1	$\mu\text{A}$	$T_A=25^{\circ}\text{C}$	$I_F=0\text{ mA}, V_O=\text{Open}, V_{CC}=15\text{ V}$		
					2					
Logic Low Output Voltage	$V_{OL}$	SFH6315T		0.15	0.4	V	$T_A=25^{\circ}\text{C}$	$I_O=1.1\text{ mA}$	$I_F=16\text{ mA}, V_{CC}=4.5\text{ V}$	
					0.5		$I_O=0.8\text{ mA}$			
		SFH6316T SFH6343T	0.15	0.4	$T_A=25^{\circ}\text{C}$	$I_O=3.0\text{ mA}$				
				0.5	$I_O=2.4\text{ mA}$					
Logic High Output Current	$I_{OH}$			0.003	0.5	$\mu\text{A}$	$T_A=25^{\circ}\text{C}$	$V_O=V_{CC}=5.5\text{ V}$	$I_F=0\text{ mA}$	
				0.01	1		$T_A=25^{\circ}\text{C}$	$V_O=V_{CC}=15.0\text{ V}$		
				50			$T_A=0-70^{\circ}\text{C}$	$V_O=V_{CC}=15.0\text{ V}$		
Transistor DC Current Gain	$h_{FE}$			150			$V_O=5\text{ V}, I_O=3\text{ mA}$			
Capacitance (Input-Output)	$C_{I-O}$			0.4		pF	$f=1\text{ MHz}$		6	
Current Transfer Ratio	CTR	SFH6315T	7	16	50	%	$T_A=25^{\circ}\text{C}$	$V_O=0.4\text{ V}$	$I_F=16\text{ mA}, V_{CC}=4.5\text{ V}$	1, 6
			5	17			$V_O=0.5\text{ V}$			
		SFH6316T SFH6343T	19	35	50	%	$T_A=25^{\circ}\text{C}$	$V_O=0.4\text{ V}$		
			15	36			$V_O=0.5\text{ V}$			

Figure 1. Test circuit for switching times

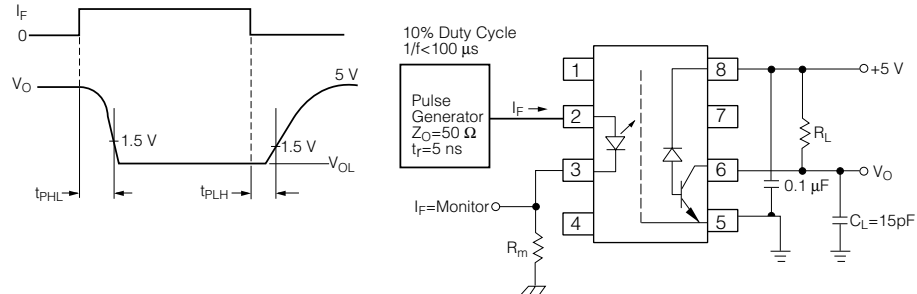

### Switching Specifications

Over recommended temperature ( $T_A=0^{\circ}\text{C}$  to  $70^{\circ}\text{C}$ ),  $V_{CC}=5\text{ V}$ ,  $I_F=16\text{ mA}$  unless otherwise specified.  
 \*All typical values,  $T_A=25^{\circ}\text{C}$ .

Parameter	Sym- bol	Device	Min.	Typ.*	Max.	Units	Test Conditions	Fig.	Note
Propagation Delay Time to Logic Low at Output	$t_{PHL}$	SFH6315T		0.5	1.5	$\mu\text{s}$	$T_A=25^{\circ}\text{C}$ $R_L=4.1\text{ K}\Omega$	1	4, 5
				2.0	$T_A=25^{\circ}\text{C}$ $R_L=1.9\text{ K}\Omega$				
		SFH6316T SFH6343T		0.25		0.8	$\mu\text{s}$		
				1.0					
Propagation Delay Time to Logic High at Output	$t_{PLH}$	SFH6315T		0.5	1.5	$\mu\text{s}$	$T_A=25^{\circ}\text{C}$ $R_L=4.1\text{ K}\Omega$	1	4, 5
				2.0	$T_A=25^{\circ}\text{C}$ $R_L=1.9\text{ K}\Omega$				
		SFH6316T SFH6343T		0.5		0.8	$\mu\text{s}$		
				1.0					
Common Mode Transient Immunity at Logic High Level Output	$ICM_{Hl}$	SFH6315T		1		$\text{kV}/\mu\text{s}$	$R_L=4.1\text{ K}\Omega$ $I_F=0\text{ mA}$ $T_A=25^{\circ}\text{C}$ $V_{CM}=10\text{ V}_{P-P}$	2	3, 4, 5
		SFH6316T		1			$R_L=1.9\text{ K}\Omega$ $I_F=0\text{ mA}$ $T_A=25^{\circ}\text{C}$ $V_{CM}=10\text{ V}_{P-P}$		
		SFH6343T	15	30			$R_L=1.9\text{ K}\Omega$ $I_F=0\text{ mA}$ $T_A=25^{\circ}\text{C}$ $V_{CM}=1500\text{ V}_{P-P}$		
Common Mode Transient Immunity at Logic Low Level Output	$ICM_{Ll}$	SFH6315T		1		$\text{kV}/\mu\text{s}$	$R_L=4.1\text{ K}\Omega$ $I_F=16\text{ mA}$ $T_A=25^{\circ}\text{C}$ $V_{CM}=10\text{ V}_{P-P}$	2	3, 4, 5
		SFH6316T		1			$R_L=1.9\text{ K}\Omega$ $I_F=16\text{ mA}$ $T_A=25^{\circ}\text{C}$ $V_{CM}=10\text{ V}_{P-P}$		
		SFH6343T	15	30			$R_L=1.9\text{ K}\Omega$ $I_F=16\text{ mA}$ $T_A=25^{\circ}\text{C}$ $V_{CM}=1500\text{ V}_{P-P}$		

### Notes

- Current transfer ratio in percent equals the ratio of output collector current ( $I_O$ ) to the forward LED input current ( $I_F$ ) times 100.
- Device considered a two-terminal device: pins 1, 2, 3, and 4 shorted together and pins 5, 6, 7, and 8 shorted together.
- Common mode transient immunity in a Logic High level is the maximum tolerable (positive)  $dV_{CM}/dt$  on the leading edge of the common mode pulse ( $V_{CM}$ ) to assure that the output will remain in a Logic High state (i.e.,  $V_O > 2.0\text{ V}$ ). Common mode transient immunity in a Logic Low level is the maximum tolerable (negative)  $dV_{CM}/dt$  on the trailing edge of the common mode pulse signal ( $V_{CM}$ ) to assure that the output will remain in a Logic Low state (i.e.,  $V_O < 0.8\text{ V}$ ).
- The 1.9 K $\Omega$  load represents 1 TTL unit load of 1.6 mA and the 5.6 k $\Omega$  pull-up resistor.
- The 4.1 K $\Omega$  load represents 1 LSTTL unit load of 0.36 mA and the 6.1 k $\Omega$  pull-up resistor.
- A 0.1  $\mu\text{F}$  bypass capacitor connected between pins 5 and 8 is recommended.

Figure 2. Test circuit for transient immunity and typical waveforms

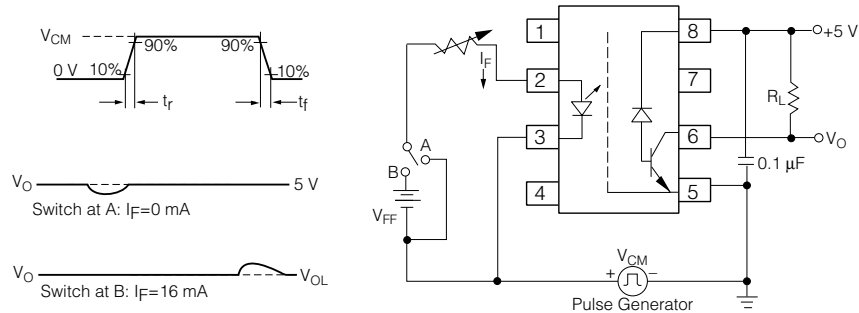

Figure 3. LED forward current vs. forward voltage

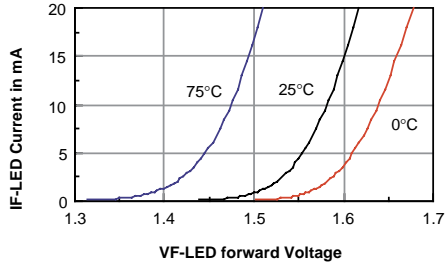

Figure 4. Permissible forward LED current vs. temperature

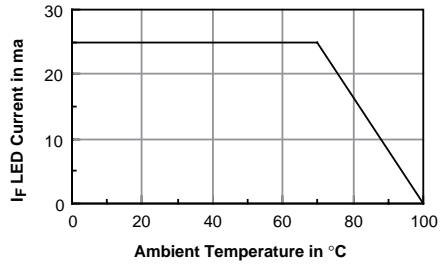

Figure 5. Permissible power dissipation vs. temp.

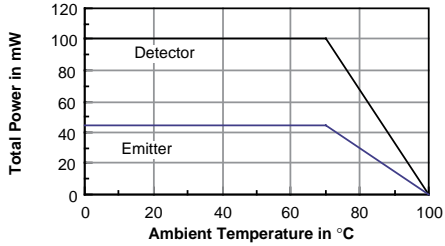

Figure 6. Output current vs. output voltage

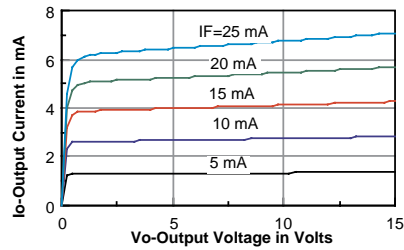

Figure 7. Output current (high) vs. temperature

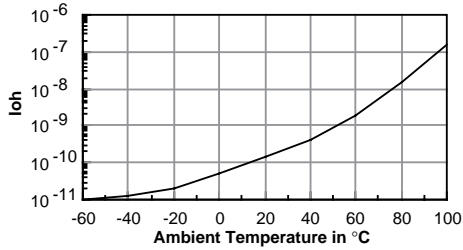

Figure 8. NCTR vs. IF

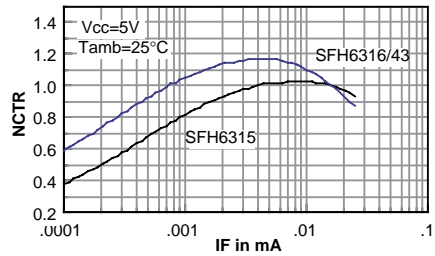

Figure 9. NCTR vs. temperature (SFH6316T/43T)

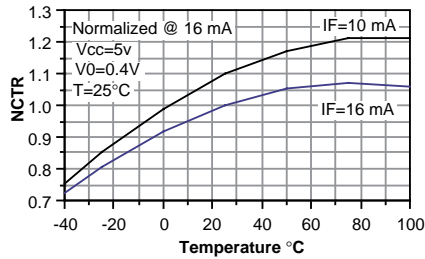

Figure 10. NCTR vs. temperature (SFH6315T)

