

FAST RECOVERY DIODES

Hockey Puk Version

Features

- High power FAST recovery diode series
- 2.0 to 3.0 μ s recovery time
- High voltage ratings up to 3000V
- High current capability
- Optimized turn on and turn off characteristics
- Low forward recovery
- Fast and soft reverse recovery
- Press-puk encapsulation
- Case style conform to JEDEC DO-200AC (K-PUK)
- Maximum junction temperature 150°C

Typical Applications

- Snubber diode for GTO
- High voltage free-wheeling diode
- Fast recovery rectifier applications

1825A
1650A

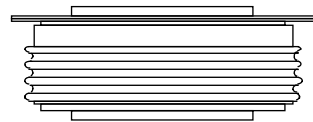

case style DO-200AC (K-PUK)

Major Ratings and Characteristics

Parameters	SD1553C..K		Units
	S20	S30	
$I_{F(AV)}$	1825	1650	A
@ T_{hs}	55	55	°C
$I_{F(RMS)}$	3100	2800	A
I_{FSM} @ 50Hz	25000	22000	A
@ 60Hz	26180	23000	A
V_{RRM} range	1800 to 2500	1800 to 3000	V
t_{rr}	2.0	3.0	μ s
@ T_J	25	25	°C
T_J	- 40 to 150		°C

SD1553C..K Series

Bulletin I2091 rev.B 04/00

International
 Rectifier

ELECTRICAL SPECIFICATIONS

Voltage Ratings

Type number	Voltage Code	V_{RRM} , maximum repetitive peak reverse voltage V	V_{RSM} , maximum non-repetitive peak rev. voltage V	I_{RRM} max. @ $T_J = T_J$ max. mA
SD1553C..S20K	18	1800	1900	75
	22	2200	2300	
	25	2500	2600	
SD1553C..S30K	18	1800	1900	
	22	2200	2300	
	25	2500	2600	
	28	2800	2900	
	30	3000	3100	

Forward Conduction

Parameter	SD1553C..K		Units	Conditions
	S20	S30		
$I_{F(AV)}$ Max. average forward current @ heatsink temperature	1825(865)	1650(790)	A	180° conduction, half sine wave
	55 (85)	55 (85)	°C	Double side (single side) cooled
$I_{F(RMS)}$ Max. RMS forward current	3100	2800	A	@ 25°C heatsink temperature double side cooled
I_{FSM} Max. peak, one-cycle forward, non-repetitive surge current	25000	22000	A	t = 10ms No voltage
	26180	23000		t = 8.3ms reapplied
	21030	18500		t = 10ms 100% V_{RRM}
	22010	19370		t = 8.3ms reapplied
I^2t Maximum I^2t for fusing	3126	2421	KA ² s	t = 10ms No voltage
	2854	2210		t = 8.3ms reapplied
	2210	1712		t = 10ms 100% V_{RRM}
	2018	1563		t = 8.3ms reapplied
$I^2\sqrt{t}$ Maximum $I^2\sqrt{t}$ for fusing	31260	24210	KA ² √s	t = 0.1 to 10ms, no voltage reapplied
$V_{F(TO)1}$ Low level value of threshold voltage	1.15	1.31	V	(16.7% x π x $I_{F(AV)}$) < I < π x $I_{F(AV)}$, $T_J = T_J$ max.
$V_{F(TO)2}$ High level value of threshold voltage	1.29	1.45		(I > π x $I_{F(AV)}$), $T_J = T_J$ max.
r_{f1} Low level value of forward slope resistance	0.27	0.32	mΩ	(16.7% x π x $I_{F(AV)}$) < I < π x $I_{F(AV)}$, $T_J = T_J$ max.
r_{f2} High level value of forward slope resistance	0.25	0.30		(I > π x $I_{F(AV)}$), $T_J = T_J$ max.
V_{FM} Max. forward voltage drop	2.23	2.60	V	$I_{pk} = 4000A$, $T_J = T_J$ max, $t_p = 10ms$ sinusoidal wave

Recovery Characteristics

Code	$T_J = 25^\circ\text{C}$ typical t_{rr} @ 25% I_{RRM} (μs)	Test conditions			Max. values @ $T_J = 150^\circ\text{C}$		
		I_{pk} Square Pulse (A)	di/dt (A/ μs)	V_r (V)	t_{rr} @ 25% I_{RRM} (μs)	Q_{rr} (μC)	I_{rr} (A)
S20	2.0	1000	100	-50	4.5	650	240
S30	3.0	1000	100	-50	5.0	780	260

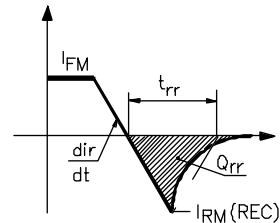

Thermal and Mechanical Specifications

Parameter	SD1553C..K		Units	Conditions
	S20	S30		
T_J Max. junction operating temperature range	-40 to 150		°C	
T_{stg} Max. storage temperature range	-40 to 150			
R_{thJ-hs} Max. thermal resistance, case junction to heatsink	0.04 0.02		K/W	DC operation single side cooled DC operation double side cooled
F Mounting force, $\pm 10\%$	22250 (2250)		N (Kg)	
wt Approximate weight	425		g	
Case style	DO-200AC (K-PUK)			See Outline Table

ΔR_{thJ-hs} Conduction

(The following table shows the increment of thermal resistance R_{thJ-hs} when devices operate at different conduction angles than DC)

Conduction angle	Sinusoidal conduction		Rectangular conduction		Units	Conditions
	Single Side	Double Side	Single Side	Double Side		
180°	0.0018	0.0019	0.0012	0.0012	K/W	$T_J = T_J \text{ max.}$
120°	0.0021	0.0021	0.0021	0.0021		
90°	0.0027	0.0027	0.0029	0.0029		
60°	0.0039	0.0039	0.0041	0.0041		
30°	0.0067	0.0067	0.0068	0.0068		

Ordering Information Table

Device Code							
SD	155	3	C	30	S30	K	
①	②	③	④	⑤	⑥	⑦	
1	- Diode	2	- Essential part number	3	- 3 = Fast recovery	4	- C = Ceramic Puk
5	- Voltage code: Code x 100 = V_{RRM} (See Voltage Ratings table)	6	- t_{rr} code	7	- K = Puk Case DO-200AC (K-PUK)		

SD1553C..K Series

Bulletin I2091 rev. B 04/00

International
IRF Rectifier

Outline Table

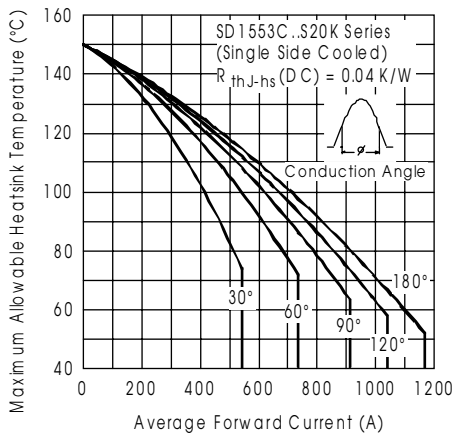
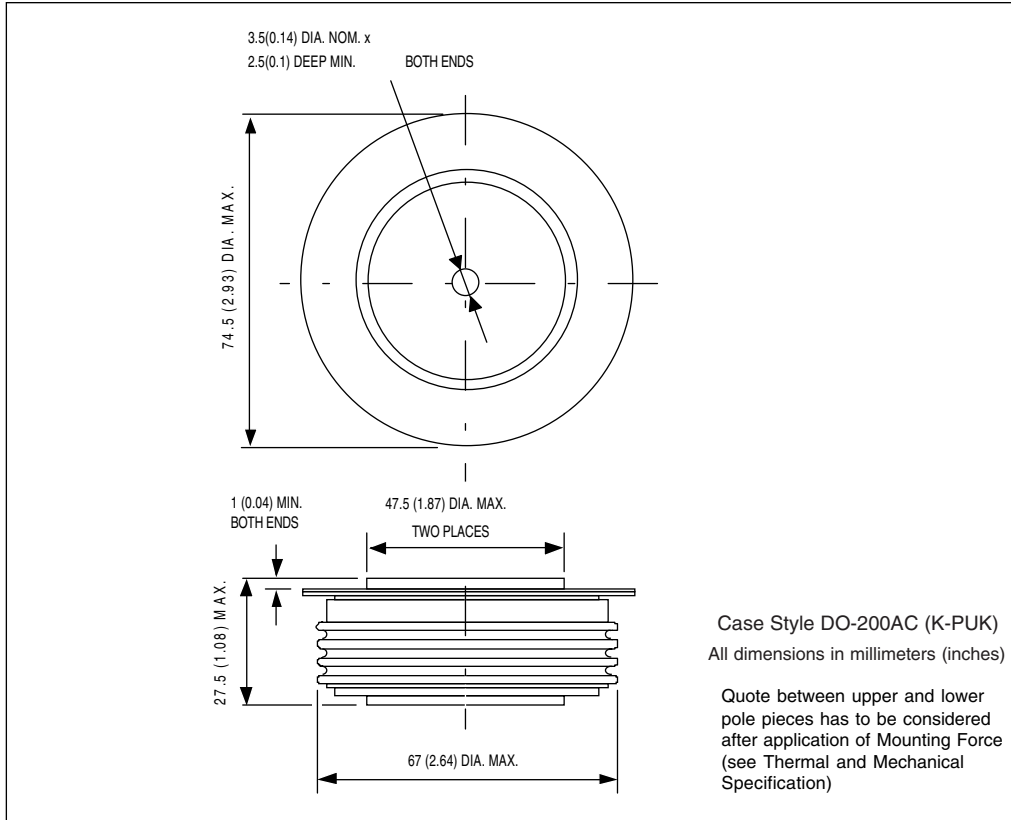

Fig. 1 - Current Ratings Characteristics

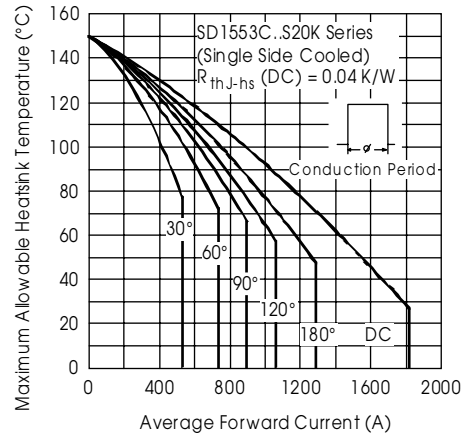

Fig. 2 - Current Ratings Characteristics

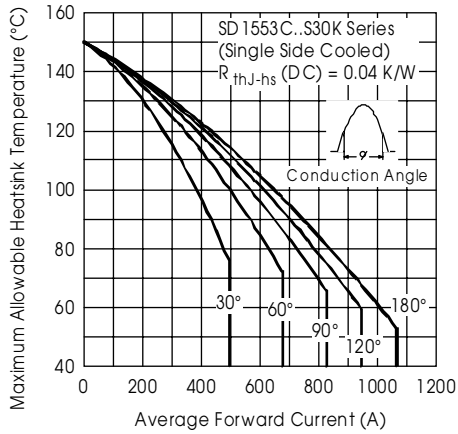

Fig. 3 - Current Ratings Characteristics

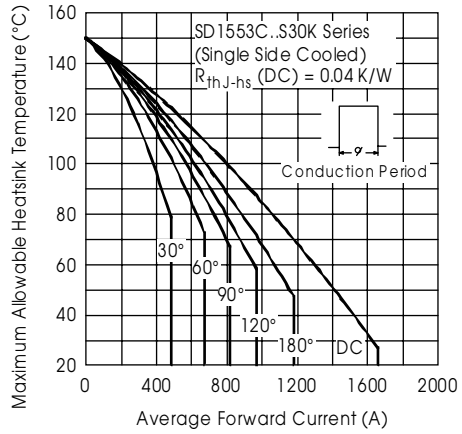

Fig. 4 - Current Ratings Characteristics

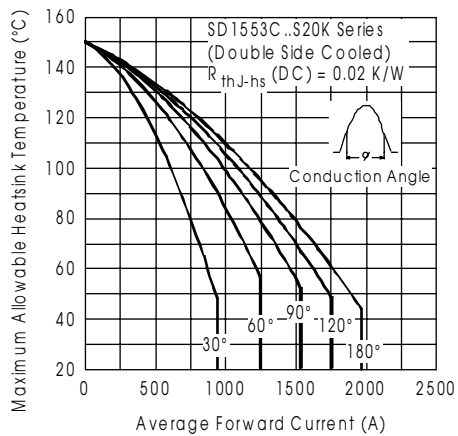

Fig. 5 - Current Ratings Characteristics

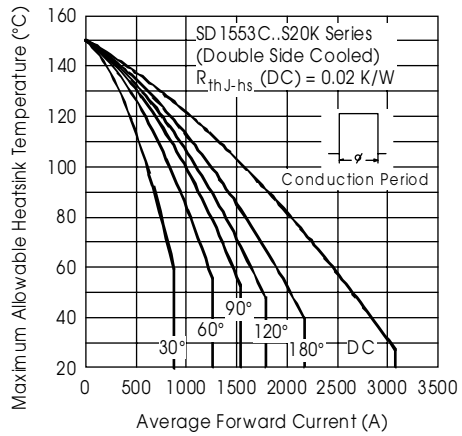

Fig. 6 - Current Ratings Characteristics

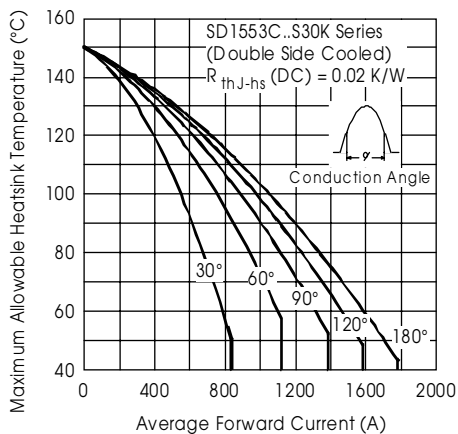

Fig. 7 - Current Ratings Characteristics

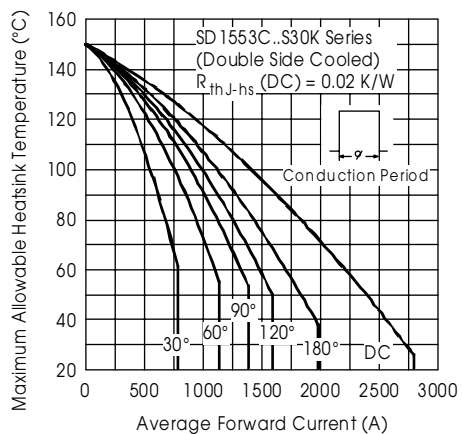

Fig. 8 - Current Ratings Characteristics

SD1553C..K Series

Bulletin I2091 rev. B 04/00

International
IR Rectifier

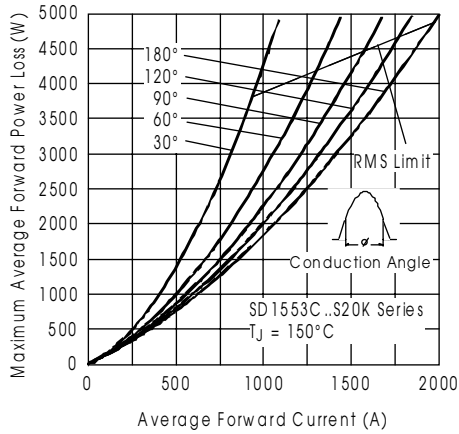

Fig. 9 - Forward Power Loss Characteristics

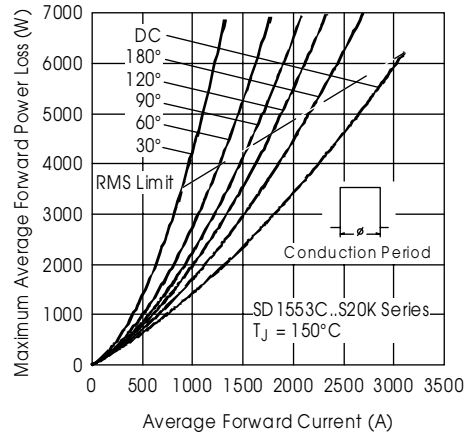

Fig. 10 - Forward Power Loss Characteristics

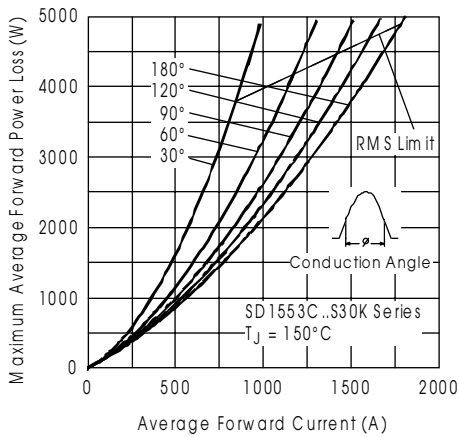

Fig. 11 - Forward Power Loss Characteristics

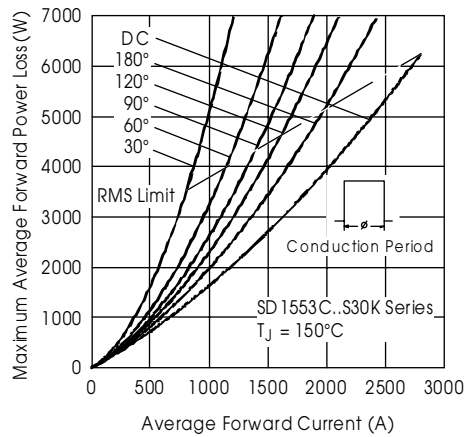

Fig. 12 - Forward Power Loss Characteristics

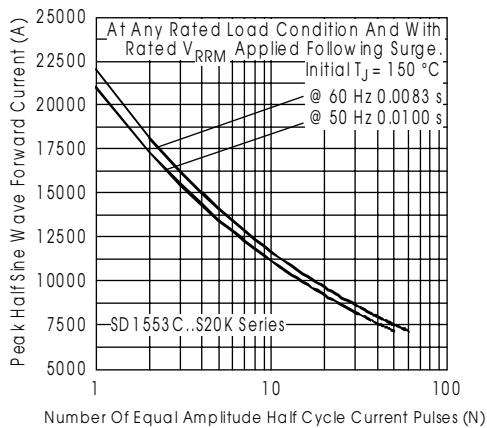

Fig. 13 - Maximum Non-repetitive Surge Current Single and Double Side Cooled

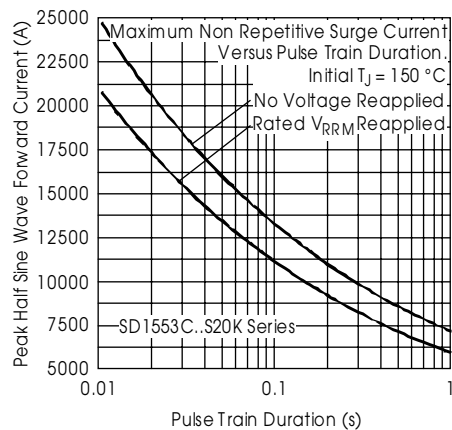

Fig. 14 - Maximum Non-repetitive Surge Current Single and Double Side Cooled

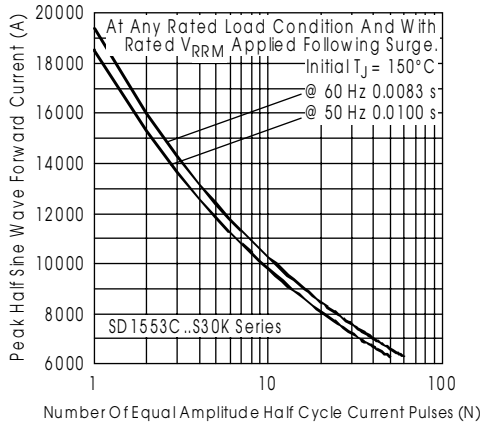

Fig. 15 - Maximum Non-repetitive Surge Current Single and Double Side Cooled

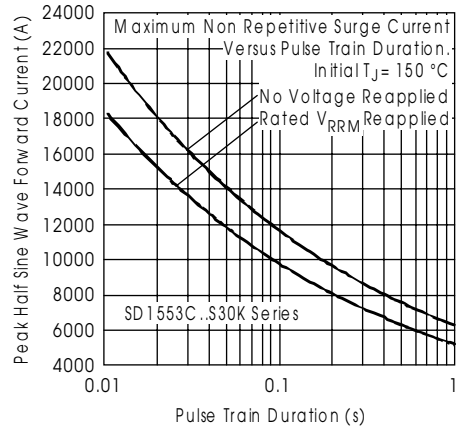

Fig. 16 - Maximum Non-repetitive Surge Current Single and Double Side Cooled

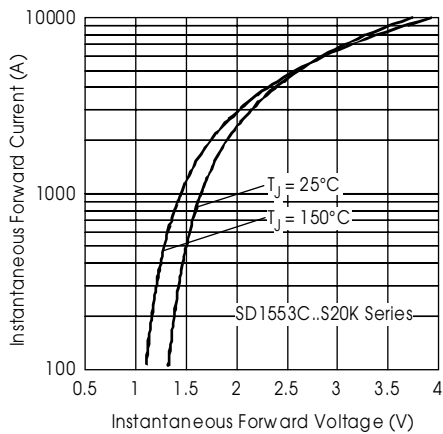

Fig. 17 - Forward Voltage Drop Characteristics

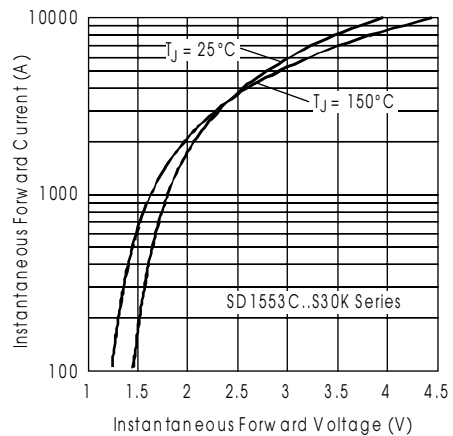

Fig. 18 - Forward Voltage Drop Characteristics

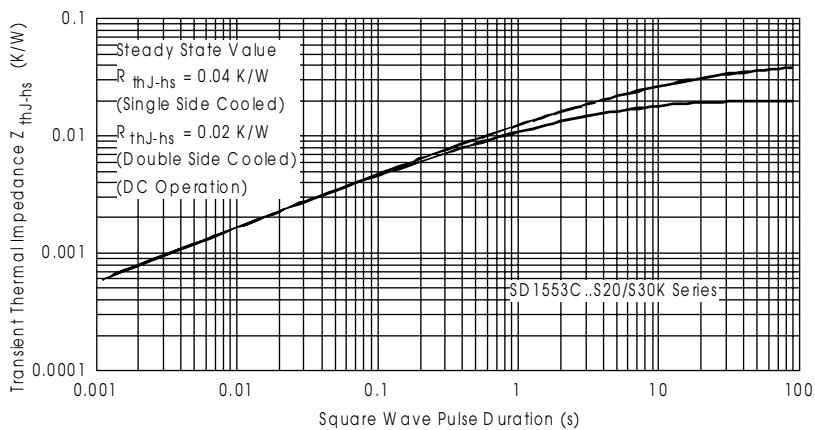

Fig. 19 - Thermal Impedance Z_{thJ-hs} Characteristic

SD1553C..K Series

Bulletin I2091 rev. B 04/00

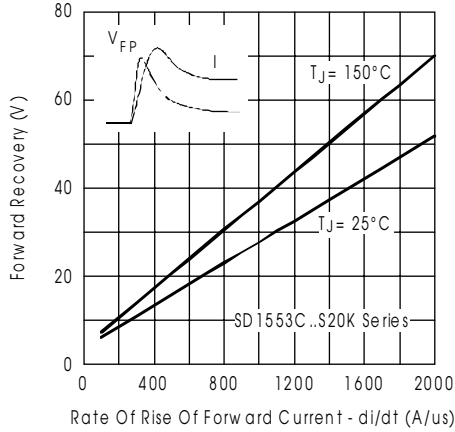

Fig. 20 - Typical Forward Recovery Characteristics

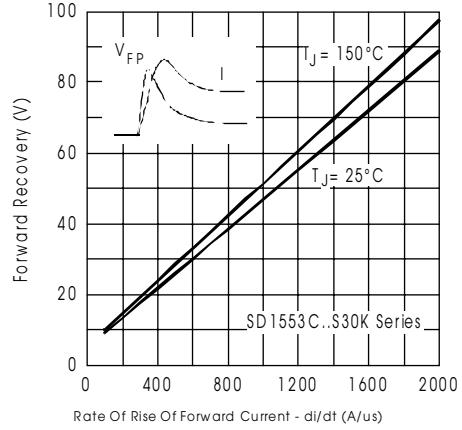

Fig. 21 - Typical Forward Recovery Characteristics

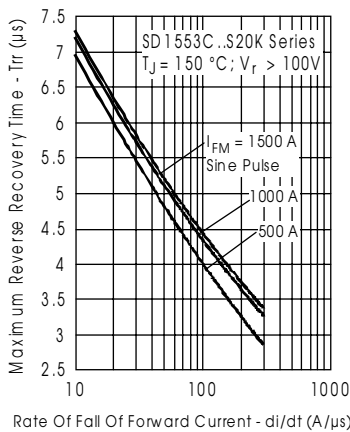

Fig. 22 - Recovery Time Characteristics

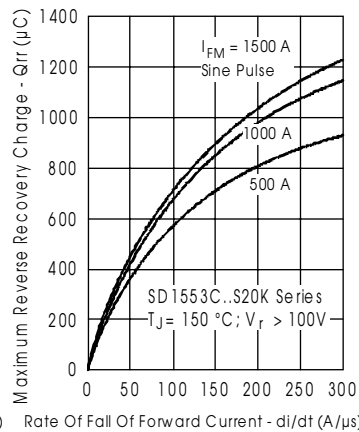

Fig. 23 - Recovery Charge Characteristics

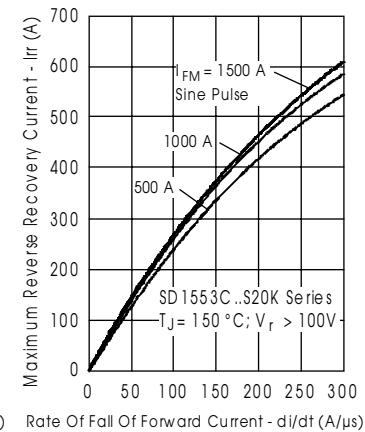

Fig. 24 - Recovery Current Characteristics

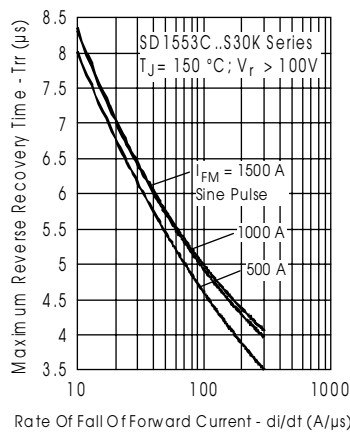

Fig. 25 - Recovery Time Characteristics

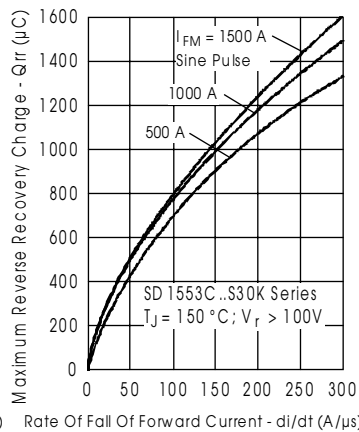

Fig. 26 - Recovery Charge Characteristics

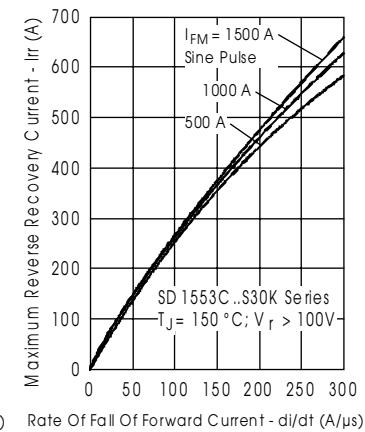

Fig. 27 - Recovery Current Characteristics

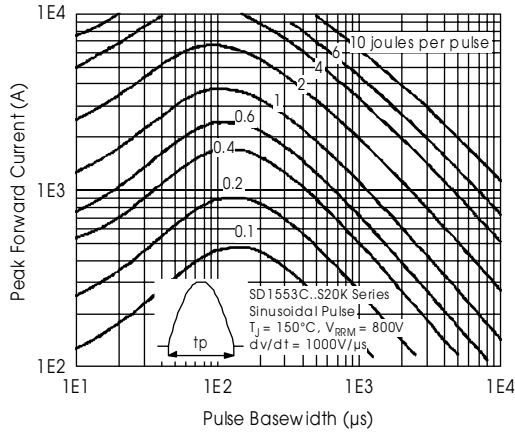

Fig. 28 - Maximum Total Energy Loss Per Pulse Characteristics

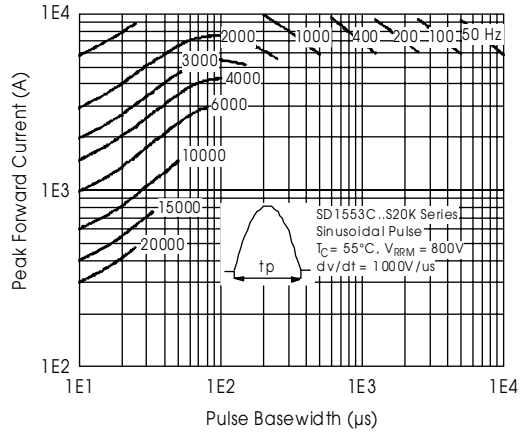

Fig. 29 - Frequency Characteristics

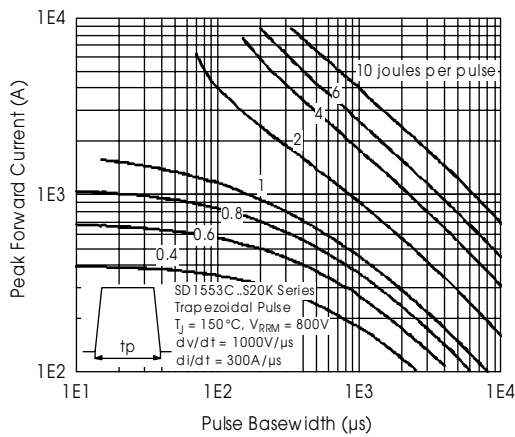

Fig. 30 - Maximum Total Energy Loss Per Pulse Characteristics

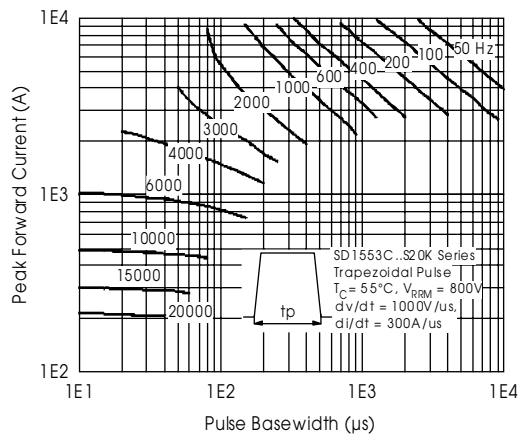

Fig. 31 - Frequency Characteristics

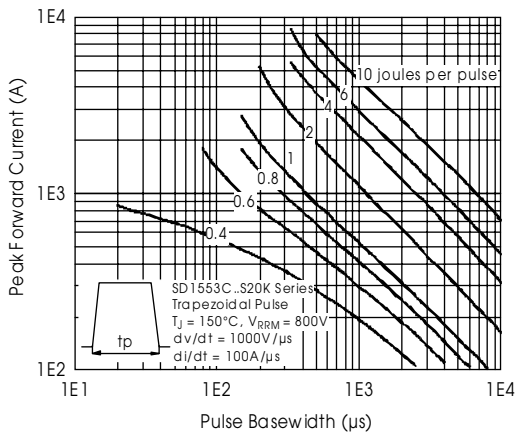

Fig. 32 - Maximum Total Energy Loss Per Pulse Characteristics

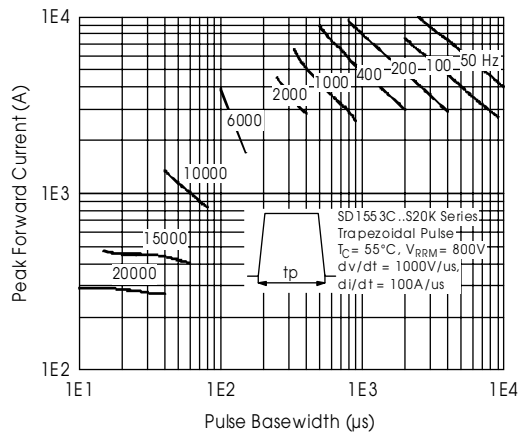

Fig. 33 - Frequency Characteristics

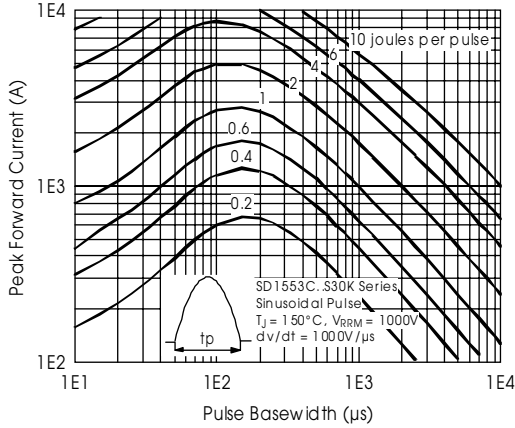

Fig. 34 - Maximum Total Energy Loss Per Pulse Characteristics

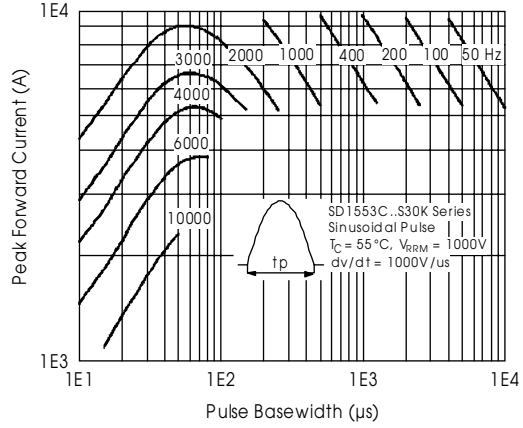

Fig. 35 - Frequency Characteristics

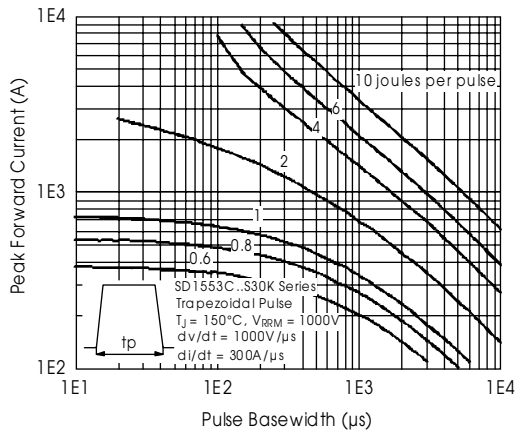

Fig. 36 - Maximum Total Energy Loss Per Pulse Characteristics

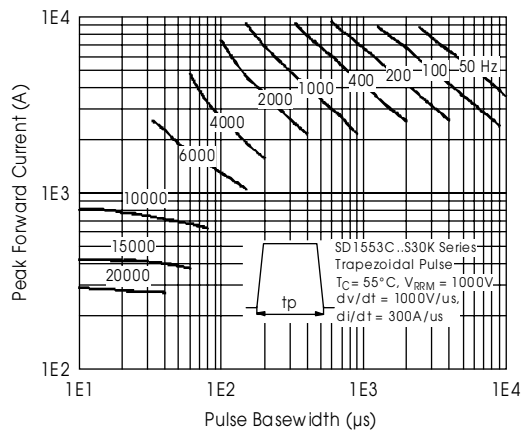

Fig. 37 - Frequency Characteristics

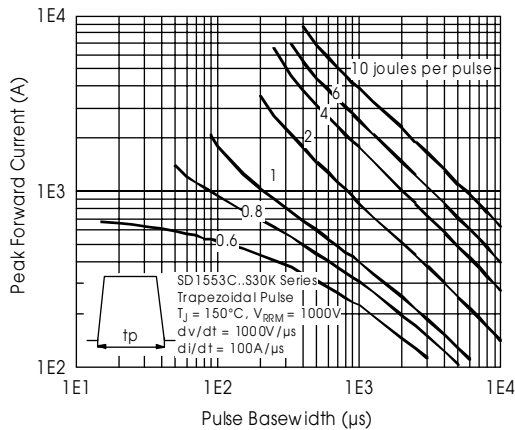

Fig. 38 - Maximum Total Energy Loss Per Pulse Characteristics

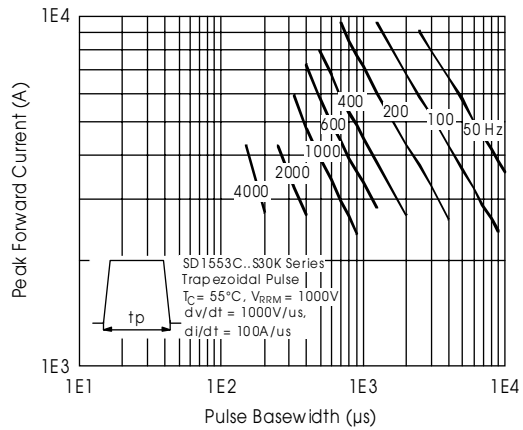

Fig. 39 - Frequency Characteristics