

4.3A, 1000V, 3.500 Ohm, High Voltage, N-Channel Power MOSFETs

The RFP4N100 and RFP4N100SM are N-Channel enhancement mode silicon gate power field effect transistors. They are designed for use in applications such as switching regulators, switching converters, motor drivers, relay drivers, and drivers for high power bipolar switching transistors requiring high speed and low gate drive power. This type can be operated directly from an integrated circuit.

Formerly developmental type TA09850.

Ordering Information

PART NUMBER	PACKAGE	BRAND
RFP4N100	TO-220AB	RFP4N100
RF1S4N100SM	TO-263AB	F1S4N100

NOTE: When ordering, use the entire part number.

Features

- 4.3A, 1000V
- $r_{DS(ON)} = 3.500\Omega$
- UIS Rating Curve (Single Pulse)
- -55°C to 150°C Operating Temperature
- Related Literature
 - TB334 "Guidelines for Soldering Surface Mount Components to PC Boards"

Symbol

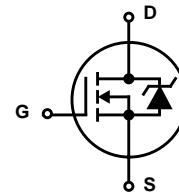

Packaging

JEDEC TO-220AB

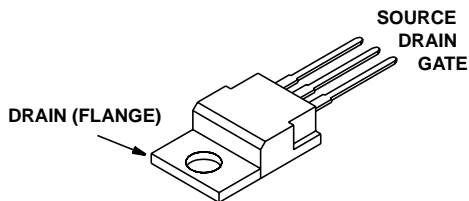

JEDEC TO-263AB

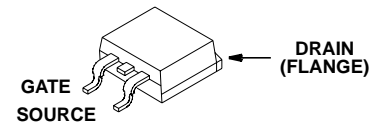

RFP4N100, RF1S4N100SM

Absolute Maximum Ratings $T_C = 25^\circ\text{C}$, Unless Otherwise Specified

	RFP4N100, RF1S4N100SM	UNITS
Drain to Source Breakdown Voltage (Note 1)	1000	V
Drain to Gate Voltage ($R_{GS} = 20k\Omega$) (Note 1)	1000	V
Continuous Drain Current	4.3	A
Pulsed Drain Current (Note 3)	17	A
Gate to Source Voltage	± 20	V
Single Pulse Avalanche Rating	(See UIS SOA Curve) (Figures 4, 14, 15)	mJ
Maximum Power Dissipation	150	W
Linear Derating Factor	1.2	W/ $^\circ\text{C}$
Operating and Storage Temperature	-55 to 150	$^\circ\text{C}$
Maximum Temperature for Soldering		
Leads at 0.063in (1.6mm) from case for 10s	300	$^\circ\text{C}$
Package Body for 10s, see Techbrief 334	260	$^\circ\text{C}$

CAUTION: Stresses above those listed in "Absolute Maximum Ratings" may cause permanent damage to the device. This is a stress only rating and operation of the device at these or any other conditions above those indicated in the operational sections of this specification is not implied.

NOTE:

1. $T_J = 25^\circ\text{C}$ to 125°C .

Electrical Specifications $T_C = 25^\circ\text{C}$, Unless Otherwise Specified

PARAMETER	SYMBOL	TEST CONDITIONS	MIN	TYP	MAX	UNITS
Drain to Source Breakdown Voltage	BV_{DSS}	$I_D = 250\mu\text{A}$, $V_{GS} = 0\text{V}$ (Figure 10)	1000	-	-	V
Gate Threshold Voltage	$V_{GS(TH)}$	$V_{GS} = V_{DS}$, $I_D = 250\mu\text{A}$	2	-	4	V
Zero Gate Voltage Drain Current	I_{DSS}	$V_{DS} = 1000\text{V}$, $V_{GS} = 0\text{V}$	-	-	25	μA
		$V_{DS} = 800\text{V}$, $V_{GS} = 0\text{V}$, $T_C = 150^\circ\text{C}$	-	-	100	μA
Gate to Source Leakage Current	I_{GSS}	$V_{GS} = \pm 20\text{V}$	-	-	± 100	nA
Drain to Source On Resistance (Note 2)	$r_{DS(ON)}$	$I_D = 2.5\text{A}$, $V_{GS} = 10\text{V}$ (Figures 8, 9)	-	-	3.500	Ω
Turn-On Delay Time	$t_{d(ON)}$	$V_{DD} = 500\text{V}$, $I_D \approx 3.9\text{A}$, $R_{GS} = 9.1\Omega$, $R_L = 120\Omega$	-	-	30	ns
Rise Time	t_r		-	-	50	ns
Turn-Off Delay Time	$t_{d(OFF)}$		-	-	170	ns
Fall Time	t_f		-	-	50	ns
Total Gate Charge (Gate to Source + Gate to Drain)	$Q_{g(TOT)}$	$V_{GS} = 20\text{V}$, $I_D = 3.9\text{A}$, $V_{DS} = 800\text{V}$ (Figure 13)	-	-	120	nC
Thermal Resistance Junction to Case	$R_{\theta JC}$		-	-	0.83	$^\circ\text{C/W}$
Thermal Resistance Junction to Ambient	$R_{\theta JA}$		-	-	62	$^\circ\text{C/W}$

Source to Drain Diode Specifications

PARAMETER	SYMBOL	TEST CONDITIONS	MIN	TYP	MAX	UNITS
Source to Drain Diode Voltage	V_{SD}	$I_{SD} = 4.3\text{A}$	-	-	1.8	V
Reverse Recovery Time	t_{rr}	$I_{SD} = 3.9\text{A}$, $dI_{SD}/dt = 100\text{A}/\mu\text{s}$	-	-	1000	ns

NOTES:

2. Pulse test: pulse width $\leq 80\mu\text{s}$, duty cycle $\leq 2\%$.
3. Repetitive rating: pulse width limited by maximum junction temperature.

Typical Performance Curves $T_C = 25^\circ\text{C}$, Unless Otherwise Specified

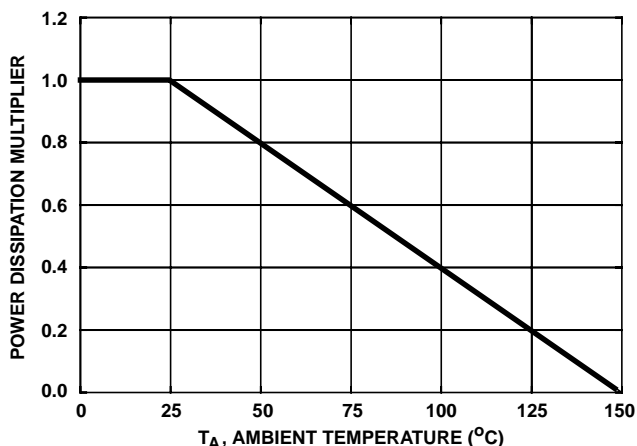

FIGURE 1. NORMALIZED POWER DISSIPATION vs AMBIENT TEMPERATURE

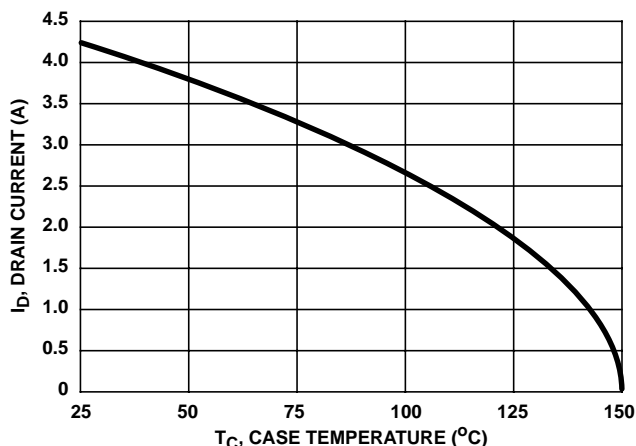

FIGURE 2. MAXIMUM CONTINUOUS DRAIN CURRENT vs CASE TEMPERATURE

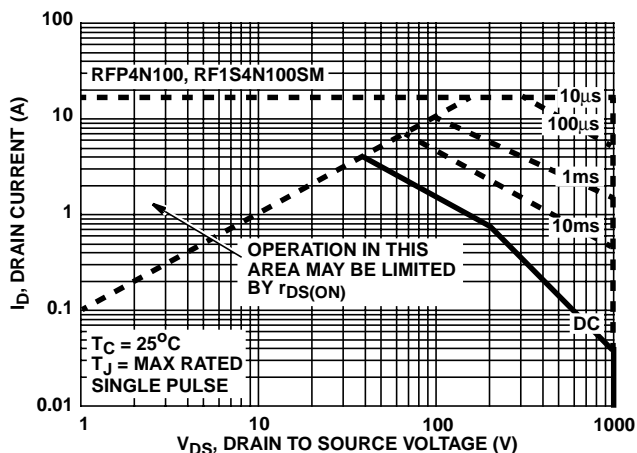

FIGURE 3. FORWARD BIAS SAFE OPERATING AREA

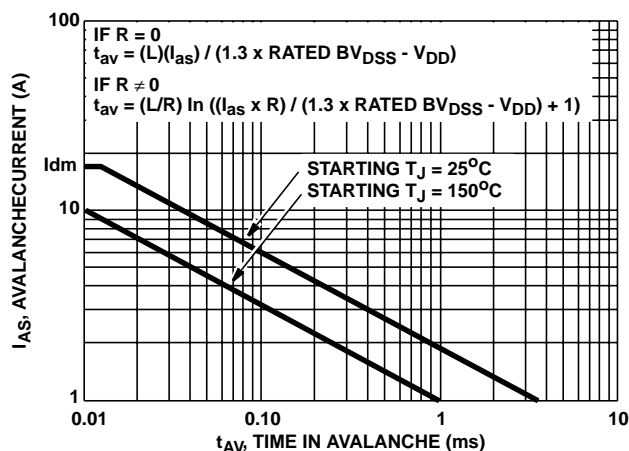

FIGURE 4. UNCLAMPED INDUCTIVE SWITCHING SOA

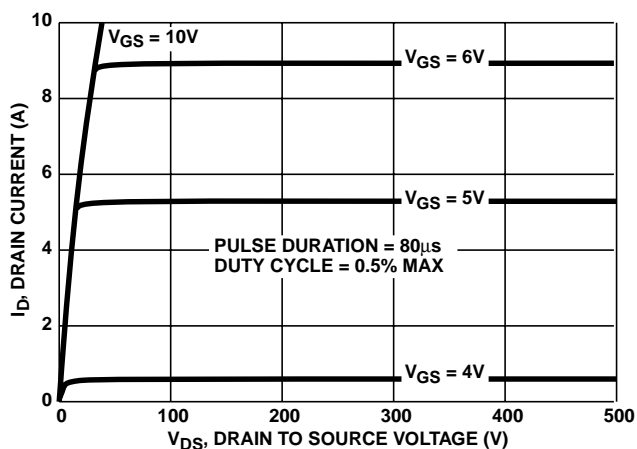

FIGURE 5. OUTPUT CHARACTERISTICS

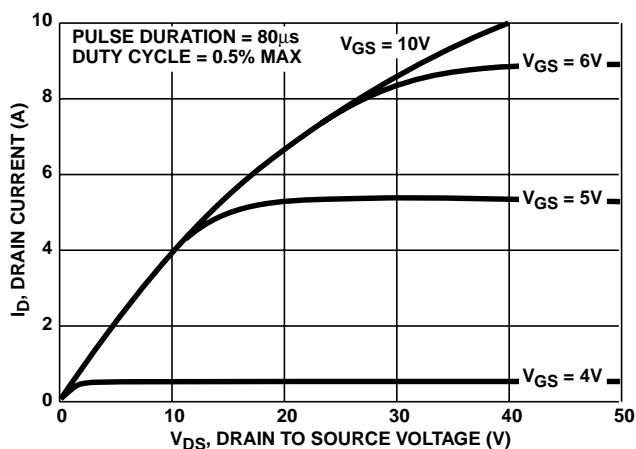

FIGURE 6. SATURATION CHARACTERISTICS

Typical Performance Curves $T_C = 25^\circ\text{C}$, Unless Otherwise Specified (Continued)

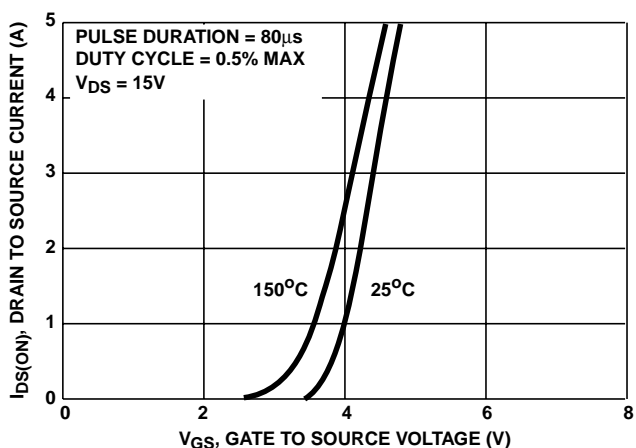

FIGURE 7. TRANSFER CHARACTERISTICS

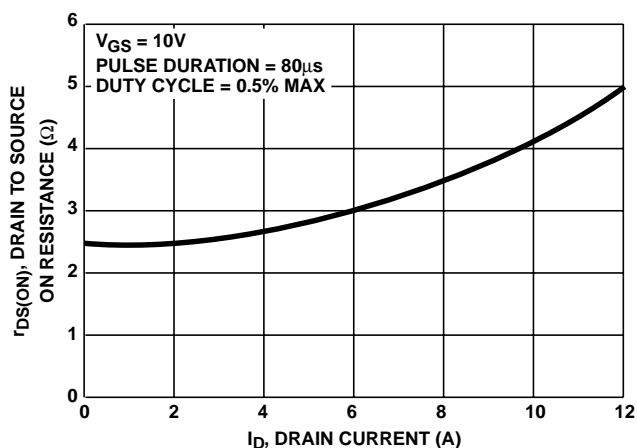

FIGURE 8. DRAIN TO SOURCE ON RESISTANCE vs DRAIN CURRENT

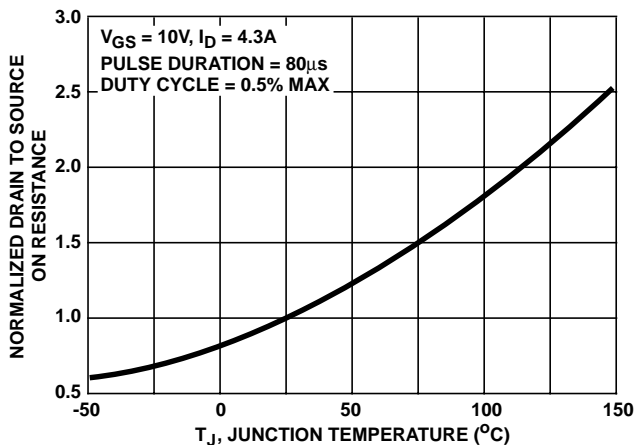

FIGURE 9. NORMALIZED DRAIN TO SOURCE ON RESISTANCE vs JUNCTION TEMPERATURE

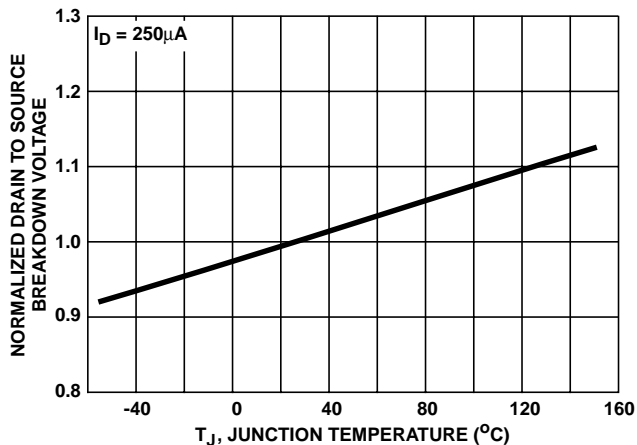

FIGURE 10. NORMALIZED DRAIN TO SOURCE BREAKDOWN VOLTAGE vs JUNCTION TEMPERATURE

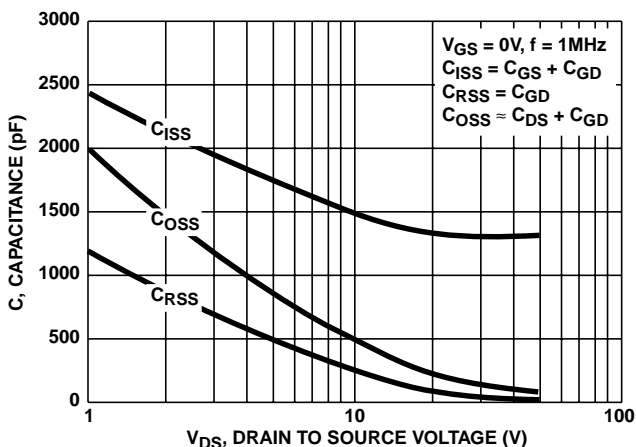

FIGURE 11. CAPACITANCE vs DRAIN TO SOURCE VOLTAGE

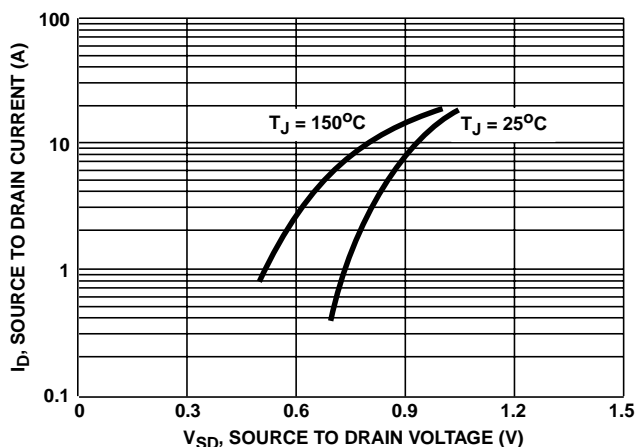

FIGURE 12. DRAIN CURRENT vs SOURCE TO DRAIN DIODE VOLTAGE

Typical Performance Curves $T_C = 25^\circ\text{C}$, Unless Otherwise Specified (Continued)

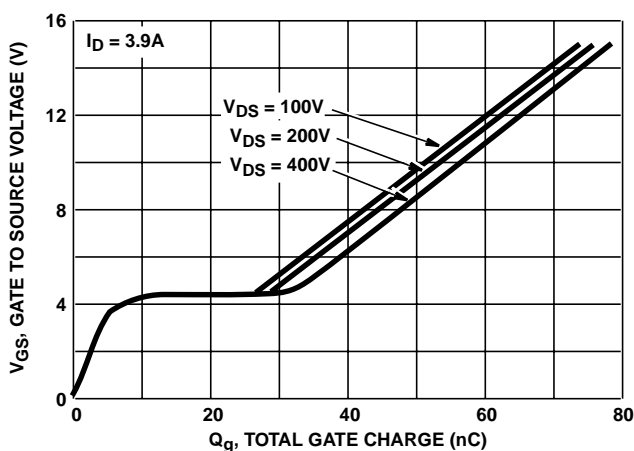

FIGURE 13. GATE TO SOURCE VOLTAGE vs GATE CHARGE

Test Circuits and Waveforms

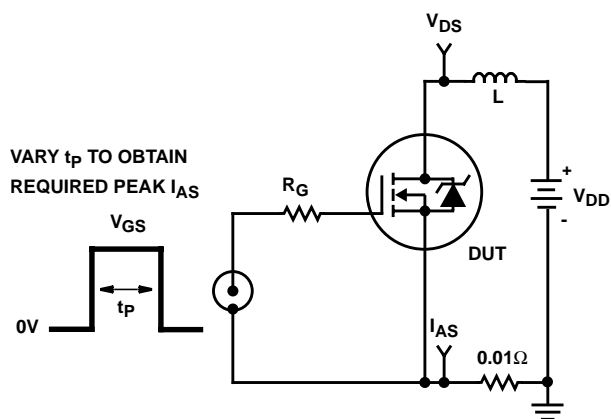

FIGURE 14. UNCLAMPED ENERGY TEST CIRCUIT

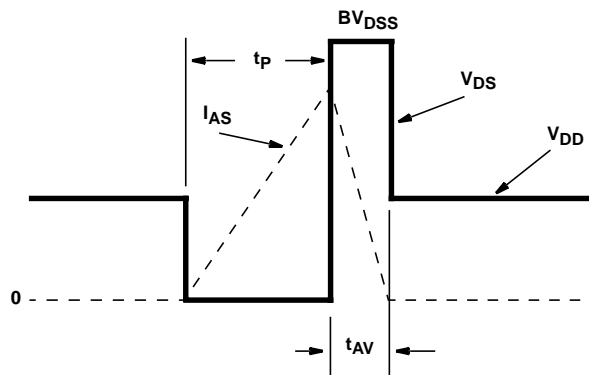

FIGURE 15. UNCLAMPED ENERGY WAVEFORMS

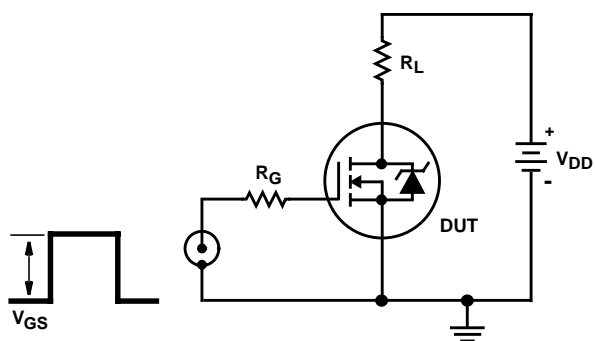

FIGURE 16. SWITCHING TIME TEST CIRCUIT

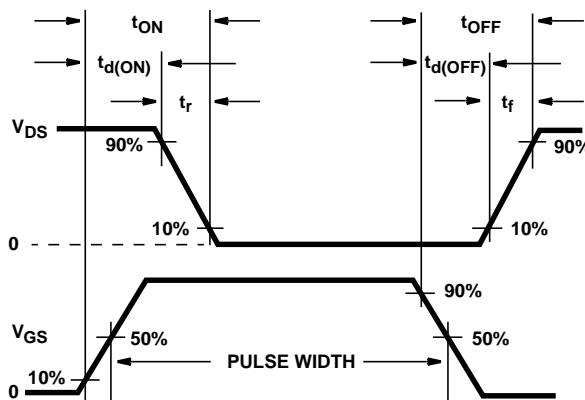

FIGURE 17. RESISTIVE SWITCHING WAVEFORMS

Test Circuits and Waveforms (Continued)

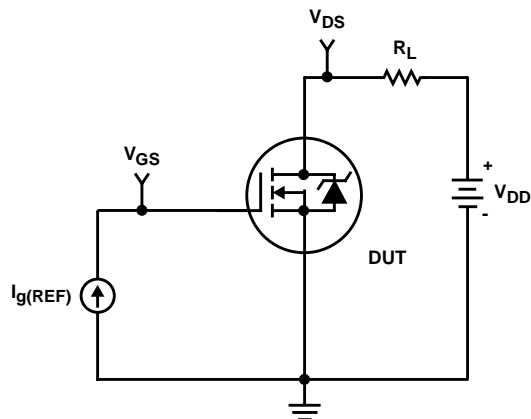

FIGURE 18. GATE CHARGE TEST CIRCUIT

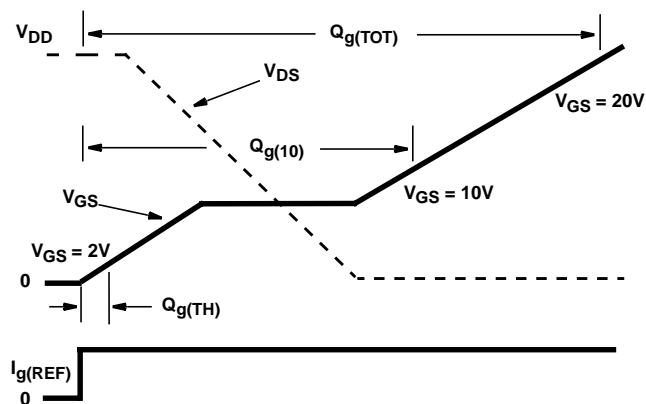

FIGURE 19. GATE CHARGE WAVEFORMS

All Intersil semiconductor products are manufactured, assembled and tested under **ISO9000** quality systems certification.

Intersil semiconductor products are sold by description only. Intersil Corporation reserves the right to make changes in circuit design and/or specifications at any time without notice. Accordingly, the reader is cautioned to verify that data sheets are current before placing orders. Information furnished by Intersil is believed to be accurate and reliable. However, no responsibility is assumed by Intersil or its subsidiaries for its use; nor for any infringements of patents or other rights of third parties which may result from its use. No license is granted by implication or otherwise under any patent or patent rights of Intersil or its subsidiaries.

For information regarding Intersil Corporation and its products, see web site <http://www.intersil.com>

Sales Office Headquarters

NORTH AMERICA

Intersil Corporation
P. O. Box 883, Mail Stop 53-204
Melbourne, FL 32902
TEL: (407) 724-7000
FAX: (407) 724-7240

EUROPE

Intersil SA
Mercure Center
100, Rue de la Fusee
1130 Brussels, Belgium
TEL: (32) 2.724.2111
FAX: (32) 2.724.22.05

ASIA

Intersil (Taiwan) Ltd.
7F-6, No. 101 Fu Hsing North Road
Taipei, Taiwan
Republic of China
TEL: (886) 2 2716 9310
FAX: (886) 2 2715 3029