

Product Features

- DC – 6 GHz
- +24 dBm P1dB at 1 GHz
- +39 dBm OIP3 at 1 GHz
- 20 dB Gain at 1 GHz
- 3.6 dB Noise Figure at 2 GHz
- SOT-89 Package and lead-free / green SOT-89
- Internally matched to 50 Ω

Applications

- Mobile Infrastructure
- CATV / DBS
- W-LAN / ISM
- RFID
- Defense / Homeland Security
- Fixed Wireless

Product Description

The ECG003 is a general-purpose buffer amplifier that offers high dynamic range in a low-cost surface-mount package. At 1000 MHz, the ECG003 typically provides 20 dB of gain, +39 dBm Output IP3, and +24 dBm P1dB.

The ECG003 consists of Darlington pair amplifiers using the high reliability InGaP/GaAs HBT process technology and only requires DC-blocking capacitors, a bias resistor, and an inductive RF choke for operation. The device is ideal for wireless applications and is available in a low-cost, surface-mountable SOT-89 package. ECG003 is also available in a lead-free/green/RoHS-compliant SOT-89 package. All devices are 100% RF and DC tested.

The broadband MMIC amplifier can be directly applied to various current and next generation wireless technologies such as GPRS, GSM, CDMA, and W-CDMA. In addition, the ECG003 will work for other various applications within the DC to 6 GHz frequency range such as CATV and fixed wireless.

Functional Diagram

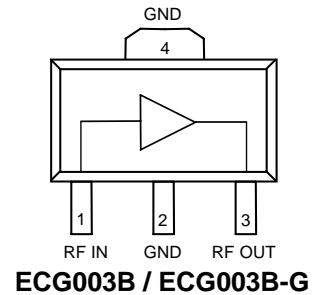

Specifications ⁽¹⁾

Parameter	Units	Min	Typ	Max
Operational Bandwidth	MHz	DC		6000
Test Frequency	MHz		1000	
Gain	dB		20	
Output P1dB	dBm		+24	
Output IP3 ⁽³⁾	dBm		+39	
Noise Figure	dB		3.5	
Test Frequency	MHz		2000	
Gain	dB	18	19	
Input Return Loss	dB		15	
Output Return Loss	dB		10	
Output P1dB	dBm		+23	
Output IP3 ⁽²⁾	dBm	+34	+36	
Noise Figure	dB		3.6	
Device Voltage	V	6.7	7.2	7.6
Device Current	mA		110	
Output mismatch w/o spurs	VSWR		10:1	

1. Test conditions unless otherwise noted: 25° C, Supply Voltage = +9 V, R_{bias} = 16 Ω, 50 Ω System.
 2. 3OIP measured with two tones at an output power of +11 dBm/tone separated by 1 MHz. The suppression on the largest IM3 product is used to calculate the 3OIP using a 2:1 rule.

Typical Performance ⁽³⁾

Parameter	Units	Typical			
Frequency	MHz	500	900	1900	2140
S21	dB	21	20	19	18.7
S11	dB	-19	-18	-16	-15
S22	dB	-14	-13	-10	-10
Output P1dB	dBm	+24.4	+24	+23	+22.5
Output IP3	dBm	+39	+39	+36	+35
Noise Figure	dB	3.5	3.5	3.6	3.7

3. Test conditions: T = 25° C, Supply Voltage = +9 V, Device Voltage = +7.2V, R_{bias} = 16Ω, 50 Ω System.

Absolute Maximum Rating

Parameter	Rating
Operating Case Temperature	-40 to +85 °C
Storage Temperature	-65 to +150 °C
RF Input Power (continuous)	+10 dBm
Device Current	160 mA
Junction Temperature	+250 °C

Operation of this device above any of these parameters may cause permanent damage.

Ordering Information

Part No.	Description
ECG003B	InGaP HBT Gain Block (lead SOT-89 Pkg)
ECG003B-G	InGaP HBT Gain Block (lead-free/green/RoHS-compliant SOT-89 Pkg)
ECG003B-PCB	700 –2400 MHz Fully Assembled Eval. Board

Specifications and information are subject to change without notice



Typical Device RF Performance ⁽³⁾

Supply Bias = +9 V, $R_{bias} = 16 \Omega$, $I_{cc} = 110 \text{ mA}$

Frequency	MHz	100	500	900	1900	2140	2400	3500	5800
S21	dB	21	21	20.4	19	18.7	18.2	17.4	14
S11	dB	-20	-19	-18	-16	-15	-13	-12	-6
S22	dB	-15	-14	-13	-10	-10	-8	-7	-3
Output P1dB	dBm	+24.4	+24.4	+24	+23	+22.5	+20.5	+18.7	12
Output IP3	dBm	+38	+39	+39	+36	+35	+34	+31	
Noise Figure	dB	3.9	3.6	3.5	3.6	3.7	3.7	4.2	

1. Test conditions: $T = 25^\circ \text{C}$, Supply Voltage = +9 V, Device Voltage = 7.2 V, $R_{bias} = 16 \Omega$, $I_{cc} = 110 \text{ mA}$ typical, 50Ω System.
2. 3OIP measured with two tones at an output power of +11 dBm/tone separated by 1 MHz. The suppression on the largest IM3 product is used to calculate the 3OIP using a 2:1 rule.
3. Data is shown as device performance only. Actual implementation for the desired frequency band will be determined by external components shown in the application circuit. The performance data does not account for losses attributed to recommended input and output series resistances shown in the application circuit on page 3.

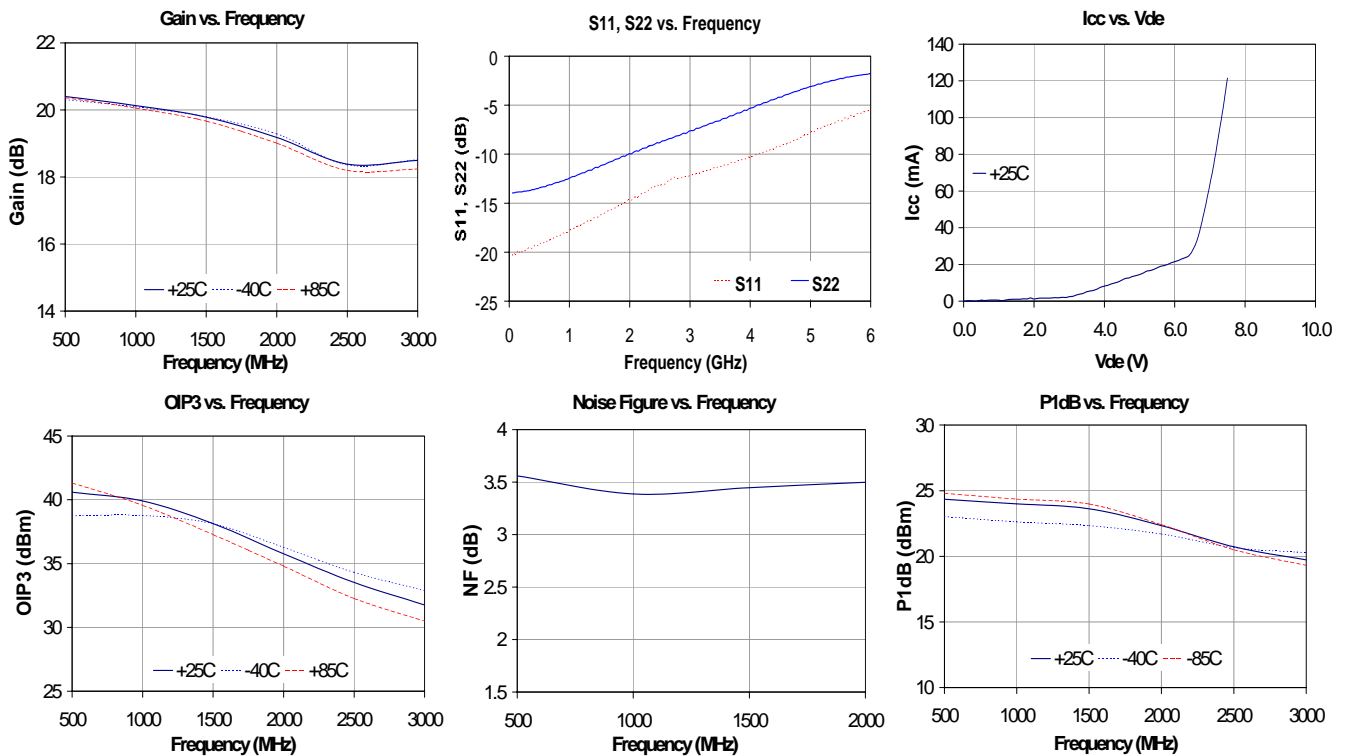

S-Parameters ($V_{device} = +7.2 \text{ V}$, $I_{cc} = 110 \text{ mA}$, $T = 25^\circ \text{C}$, calibrated to device leads)

Freq (MHz)	S11 (dB)	S11 (ang)	S21 (dB)	S21 (ang)	S12 (dB)	S12 (ang)	S22 (dB)	S22 (ang)
50	-20.36	-0.18	20.46	177.69	-23.19	-0.38	-13.95	-2.86
500	-19.29	-24.13	20.19	157.68	-23.08	-2.33	-13.44	-35.26
1000	-17.78	-51.50	19.84	136.88	-22.93	-4.52	-12.45	-68.47
1500	-16.23	-75.63	19.40	117.06	-22.61	-7.13	-11.26	-97.26
2000	-14.71	-98.28	19.06	97.71	-22.16	-9.76	-9.96	-123.04
2500	-13.16	-118.71	18.65	78.13	-21.61	-13.40	-8.82	-145.90
3000	-12.14	-139.91	18.23	59.26	-20.91	-17.67	-7.63	-167.85
3500	-11.24	-161.53	17.77	40.27	-20.11	-23.92	-6.59	-171.00
4000	-10.30	174.59	17.32	20.70	-19.35	-31.44	-5.32	150.44
4500	-9.20	147.71	16.71	0.41	-18.62	-41.28	-4.19	128.81
5000	-7.76	120.30	15.97	-19.87	-18.16	-52.98	-3.10	107.78
5500	-6.63	92.76	14.85	-40.81	-18.05	-66.03	-2.28	87.09
6000	-5.54	70.28	13.49	-59.45	-18.34	-79.15	-1.78	67.70

Device S-parameters are available for download off of the website at: <http://www.wj.com>

Specifications and information are subject to change without notice

Recommended Application Circuit

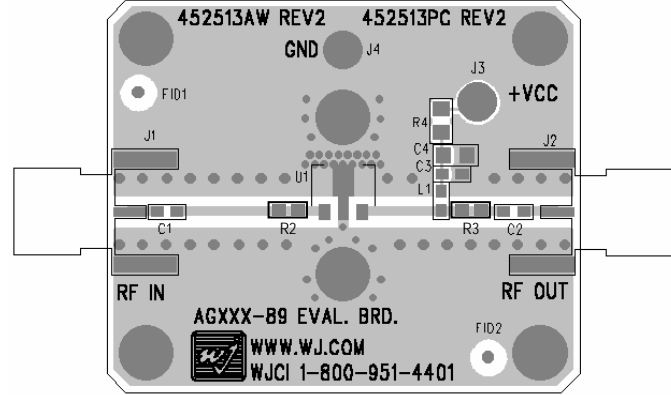
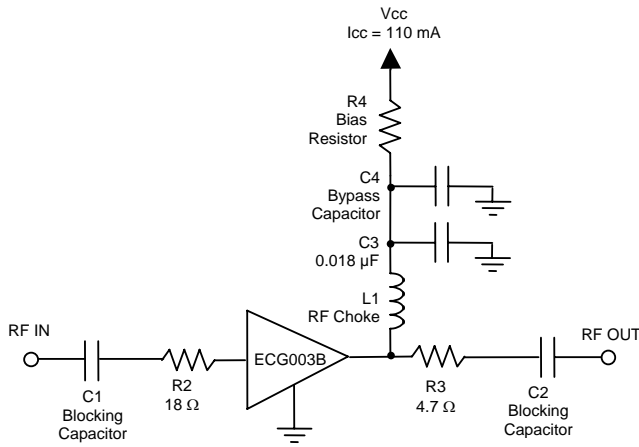

Recommended Component Values

Reference Designator	Frequency (MHz)						
	50	500	900	1900	2200	2500	3500
L1	820 nH	220 nH	68 nH	27 nH	22 nH	18 nH	15 nH
C1, C2, C4	.018 μF	1000 pF	100 pF	68 pF	68 pF	56 pF	39 pF

Recommended Bias Resistor Values

Supply Voltage	R1 value	Size
9 V	16 ohms	2010
10 V	25 ohms	2512
12 V	44 ohms	2512

- The proper values for the components are dependent upon the intended frequency of operation.
- The component values in the table below are contained on the evaluation board to achieve optimal broadband performance.
- R2 and R3 are shown in the circuit diagram to avoid potential instabilities. The configuration shown above assures of unconditional stability with the use of the device. It is expected that linearity parameters (OIP3 and P1dB) to degrade about only 0.5 dB, while overall gain will be about 2 dB less than the performance shown in page 1 and 2 of this datasheet. Input and output return loss is expected to improve with the use of the I/O series resistances at 2 GHz.

The proper value for R1 is dependent upon the supply voltage and allows for bias stability over temperature. WJ recommends a minimum supply bias of +9 V. A 1% tolerance resistor is recommended.

Ref. Desig.	Value / Type	Size
L1	39 nH wirewound inductor	0603
C1, C2	56 pF chip capacitor	0603
C3	0.018 μF chip capacitor	0603
C4	Do Not Place	
R2	18 Ω chip resistor	0603
R3	4.7 Ω chip resistor	0603
R4	16 Ω 1% tolerance	2010

ECG003B-PCB Performance Data (WJ's evaluation board uses the circuit shown above.)

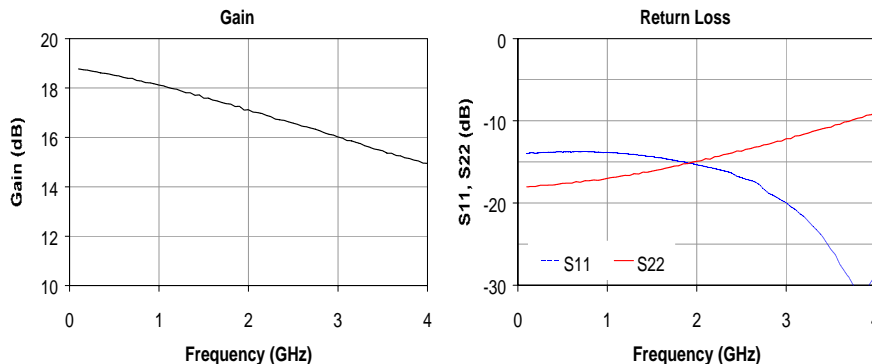

Specifications and information are subject to change without notice

ECG003B (SOT-89 Package) Mechanical Information

This package may contain lead-bearing materials. The plating material on the leads is SnPb.

Outline Drawing

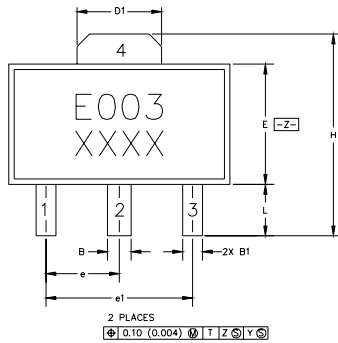

SYMBOL	MIN	MAX
A	1.40 (.055)	1.60 (.063)
B	.44 (.017)	.56 (.022)
B1	.36 (.014)	.48 (.019)
C	.35 (.014)	.44 (.017)
D	4.40 (.173)	4.60 (.181)
D1	1.62 (.064)	1.83 (.072)
E	2.29 (.079)	2.60 (.102)
E1	2.13 (.084)	2.29 (.090)
e	1.50 BSC (.059)	
e1	3.00 BSC (.118)	
H	3.94 (.155)	4.25 (.167)
L	.89 (.035)	1.20 (.047)
M	4.04 (.159)	4.19 (.165)

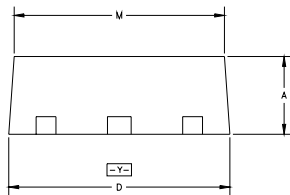

- NOTES:
1. DIMENSIONS CONFORM WITH JEDEC TO-243C EXCEPT WHERE INDICATED.
 2. DIMENSIONS ARE EXPRESSED IN MILLIMETERS(INCHES).
 3. DIMENSIONING AND TOLERANCING IAW ANSI Y14.5M

Product Marking

The component will be marked with an "E003" designator with an alphanumeric lot code on the top surface of the package.

Tape and reel specifications for this part are located on the website in the "Application Notes" section.

MSL / ESD Rating



Caution! ESD sensitive device.

ESD Rating: Class 1A
 Value: Passes between 250 and 500V
 Test: Human Body Model (HBM)
 Standard: JEDEC Standard JESD22-A114

MSL Rating: Level 3 at +235° C convection reflow
 Standard: JEDEC Standard J-STD-020

Land Pattern

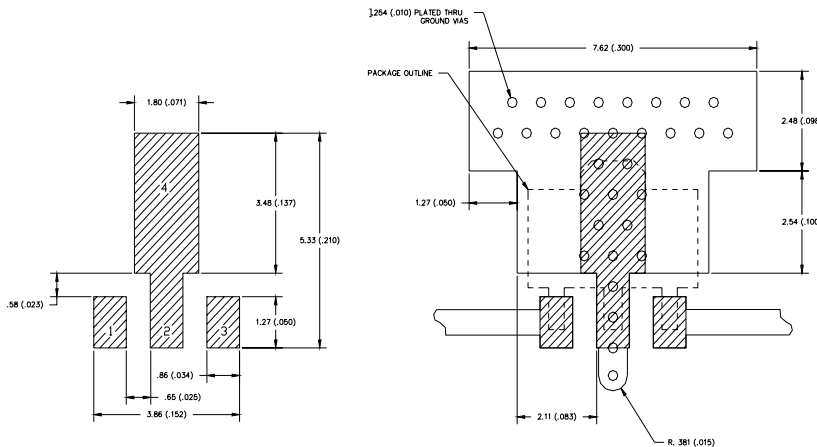

Mounting Config. Notes

1. Ground / thermal vias are critical for the proper performance of this device. Vias should use a .35mm (#80 / .0135") diameter drill and have a final plated thru diameter of .25 mm (.010").
2. Add as much copper as possible to inner and outer layers near the part to ensure optimal thermal performance.
3. Mounting screws can be added near the part to fasten the board to a heatsink. Ensure that the ground / thermal via region contacts the heatsink.
4. Do not put solder mask on the backside of the PC board in the region where the board contacts the heatsink.
5. RF trace width depends upon the PC board material and construction.
6. Use 1 oz. Copper minimum.
7. All dimensions are in millimeters (inches). Angles are in degrees.

ECG003B-G (Green / Lead-free SOT-89 Package) Mechanical Information

This package is lead-free/Green/RoHS-compliant. It is compatible with both lead-free (maximum 260°C reflow temperature) and leaded (maximum 245°C reflow temperature) soldering processes. The plating material on the leads is NiPdAu.

Outline Drawing

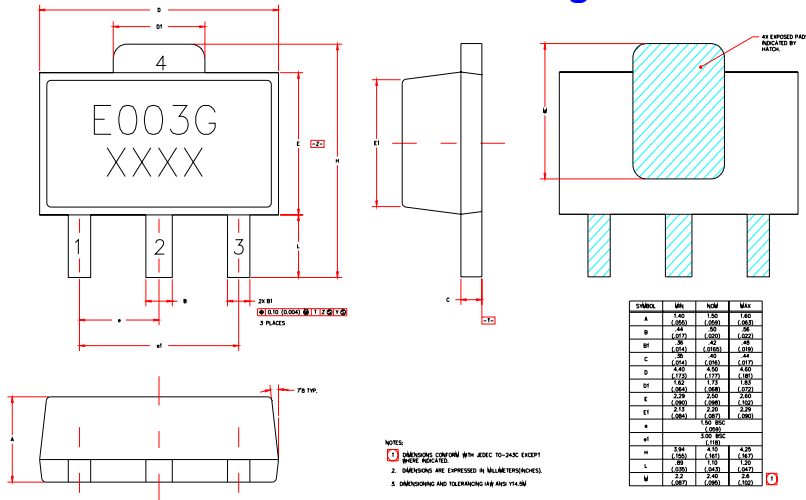

Product Marking

The component will be marked with an “E003G” designator with an alphanumeric lot code on the top surface of the package.

Tape and reel specifications for this part are located on the website in the “Application Notes” section.

MSL / ESD Rating



Caution! ESD sensitive device.

ESD Rating: Class 1A
 Value: Passes between 250 and 500V
 Test: Human Body Model (HBM)
 Standard: JEDEC Standard JESD22-A114

MSL Rating: Level 3 at +260° C convection reflow
 Standard: JEDEC Standard J-STD-020

Land Pattern

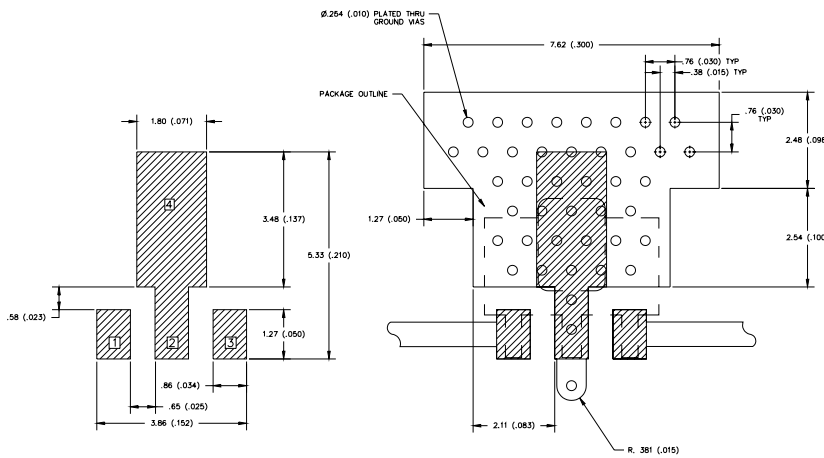

Mounting Config. Notes

1. Ground / thermal vias are critical for the proper performance of this device. Vias should use a .35mm (#80 / .0135”) diameter drill and have a final plated thru diameter of .25 mm (.010”).
2. Add as much copper as possible to inner and outer layers near the part to ensure optimal thermal performance.
3. Mounting screws can be added near the part to fasten the board to a heatsink. Ensure that the ground / thermal via region contacts the heatsink.
4. Do not put solder mask on the backside of the PC board in the region where the board contacts the heatsink.
5. RF trace width depends upon the PC board material and construction.
6. Use 1 oz. Copper minimum.
7. All dimensions are in millimeters (inches). Angles are in degrees.