

EE-SY169/169A

Phototransistor Output with Convergent Lens for Precise Sensing

- Sensing accuracy as high as ± 0.6 mm
- Model with a red LED assures smooth sensing of dyestuffs (EE-SY169)
- Ideal to be built into printers and copy machines for sensing paper edges

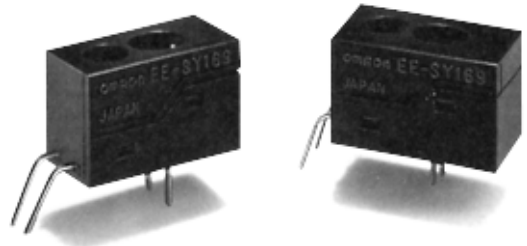

Ordering Information

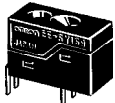
Appearance	Sensing method	Sensing distance	Sensing object	Output configuration	Weight	Part number
	Reflective, convergent lens	4 mm	White paper with reflection factor of 90%	Phototransistor	Approx. 1.0 g	EE-SY169 Red LED
						EE-SY169A IR LED

Specifications

■ ABSOLUTE MAXIMUM RATINGS ($T_A = 25^\circ\text{C}$ (77°F))

Item	Symbol	Rated value		
		EE-SY169	EE-SY169A	
Input	Forward current	I_F	40 mA*	50 mA*
	Pulse forward current	I_{FP}	300 mA**	1 A**
	Reverse voltage	V_R	3 V	3 V
Output	Collector-emitter voltage	V_{CEO}	30 V	30 V
	Collector current	I_C	20 mA	20 mA
	Collector dissipation	P_C	100 mW	100 mW
Ambient temperature	Operating	T_{opr}	0°C to 70°C** (32°F to 158°F)	0°C to 70°C** (32°F to 158°F)
	Storage	T_{stg}	-20°C to 80°C (-4°F to 176°F)	-20°C to 80°C (-4°F to 176°F)

*Refer to Engineering Data if the ambient temperature is not within the normal room temperature range.

**This value was measured with a pulse width of 10 μs and a repeating frequency of 100 Hz.

CHARACTERISTICS (T_A = 25°C (77°F))

Item		Symbol	EE-SY169		EE-SY169A	
			Value	Condition	Value	Condition
Emitter	Forward voltage	V _F	2.3 V max.	I _F = 20 mA	1.5 V max.	I _F = 30 mA
	Reverse current	I _R	10 μA max.	V _R = 3 V	10 μA max.	V _R = 4 V
	Peak emission wavelength	λ _{p(L)}	660 nm typ.	I _F = 20 mA	920 nm typ.	I _F = 20 mA
Receiver	Dark current	I _D	200 nA max.	V _{CE} = 5 V, 0/x	200 nA max.	V _{CE} = 5 V, 0/x
	Peak spectral sensitivity wavelength	λ _{p(P)}	850 nm typ.	V _{CE} = 5 V	850 nm typ.	V _{CE} = 5 V
Combination	Light current	I _L	160 to 2,000 μA	I _F = 20 mA* V _{CE} = 5 V	160 to 2,000 μA	I _F = 20 mA* V _{CE} = 10 V
	Leakage current	I _{LEAK}	2 μA max.	I _F = 20 mA** V _{CE} = 5 V	2 μA max.	I _F = 20 mA** V _{CE} = 10 V
	Rising time***	t _r	30 μs typ.	V _{CC} = 5 V R _L = 1 kΩ I _L = 1 mA	30 μs typ.	V _{CC} = 5 V R _L = 1 kΩ I _L = 1 mA
	Falling time***	t _f	30 μs typ.		30 μs typ.	

*The sensing object is white paper with a reflection factor of 90% at a sensing distance of 4.0 mm.

**The sensing object reflects no light.

***The following illustrations show the rising time, t_r, and the falling time, t_f.

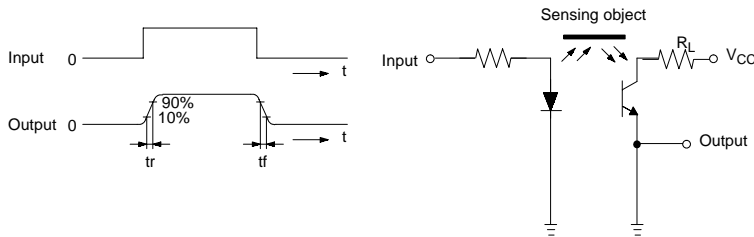

Engineering Data

Note: The operating conditions of the photomicrosensor must be within the absolute maximum rating ranges.

TEMPERATURE CHARACTERISTICS

EE-SY169

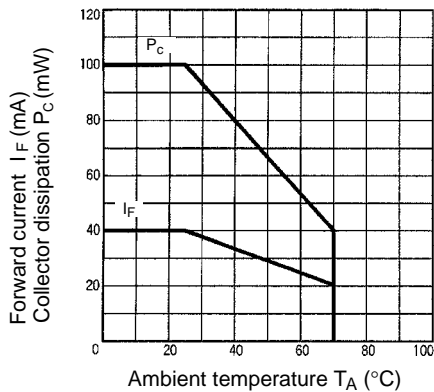

EE-SY169A

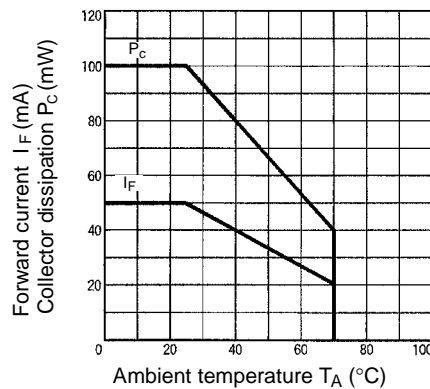

INPUT CHARACTERISTICS (TYPICAL)

EE-SY169

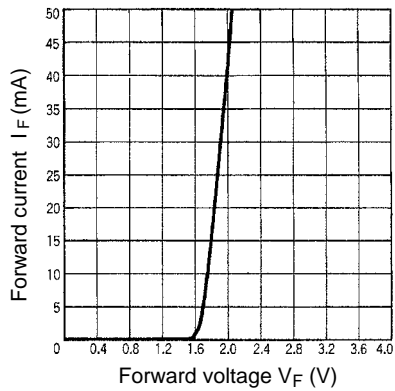

EE-SY169A

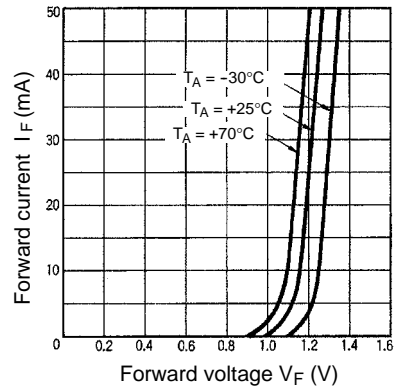

INPUT/OUTPUT CHARACTERISTICS (TYPICAL)

EE-SY169

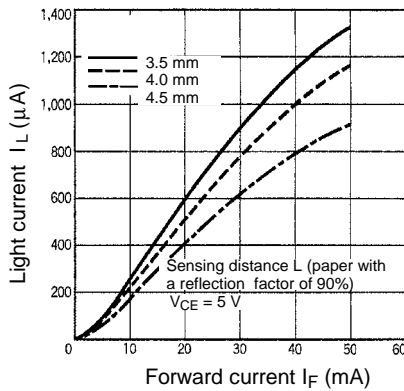

EE-SY169A

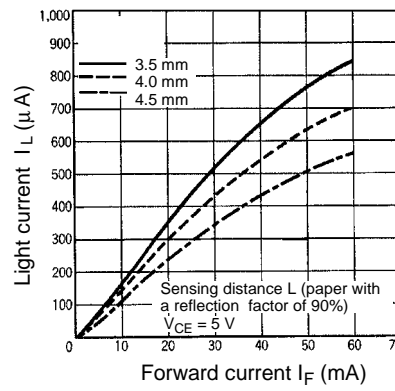

OUTPUT CHARACTERISTICS (TYPICAL)

EE-SY169

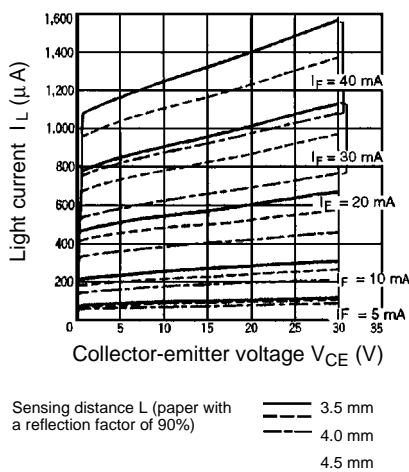

EE-SY169A

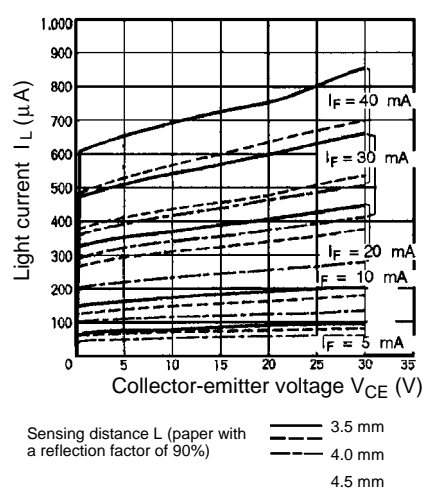

■ LIGHT CURRENT TEMPERATURE DEPENDENCY (TYPICAL)

EE-SY169

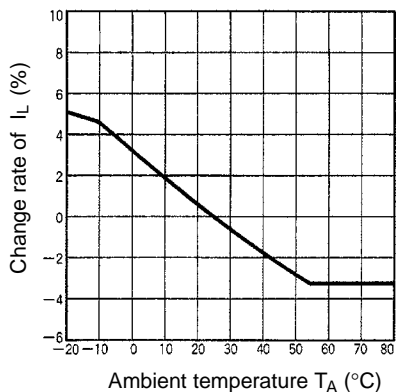

Sensing distance $L = 4.0$ mm (paper with a reflection factor of 90%)

$I_F = 20$ mA

$V_{CE} = 5$ V

EE-SY169A

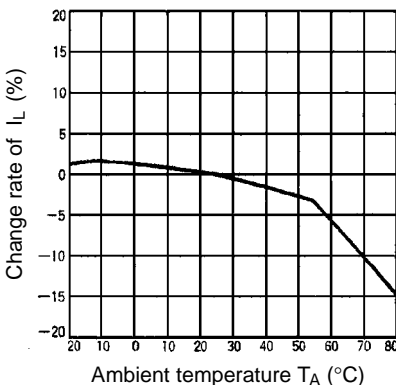

Sensing distance $L = 4.0$ mm (paper with a reflection factor of 90%)

$I_F = 20$ mA

$V_{CE} = 5$ V

■ SENSING POSITION CHARACTERISTICS (TYPICAL)

EE-SY169

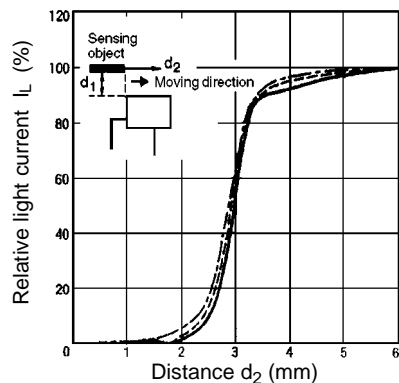

$T_A = 25$ °C

$I_F = 20$ mA

$V_{CE} = 5$ V

Sensing object: White paper with a reflection factor of 90%

— 3.5 mm
 - - - 4.0 mm
 - · - 4.5 mm

EE-SY169A

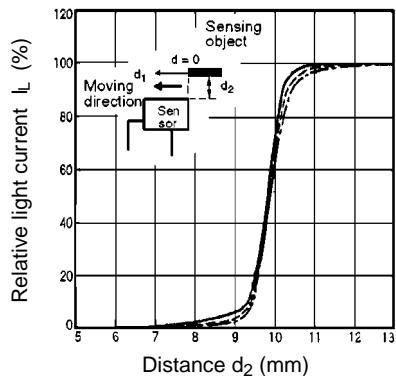

$T_A = 25$ °C

$I_F = 20$ mA

$V_{CE} = 5$ V

Sensing object: White paper with a reflection factor of 90%

— 3.5 mm
 - - - 4.0 mm
 - · - 4.5 mm

EE-SY169

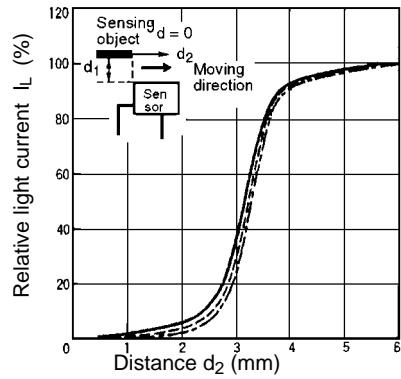

$T_A = 25\text{ }^\circ\text{C}$
 $I_F = 20\text{ mA}$
 $V_{CE} = 5\text{ V}$
 Sensing object: White paper with a reflection factor of 90%

EE-SY169A

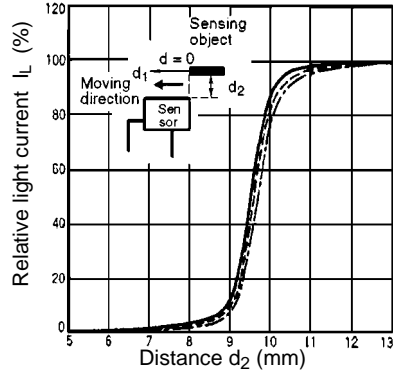

$T_A = 25\text{ }^\circ\text{C}$
 $I_F = 20\text{ mA}$
 $V_{CE} = 5\text{ V}$
 Sensing object: White paper with a reflection factor of 90%

LEAKAGE CURRENT CHARACTERISTICS (TYPICAL)

EE-SY169

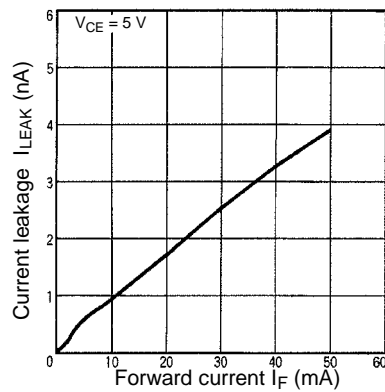

EE-SY169A

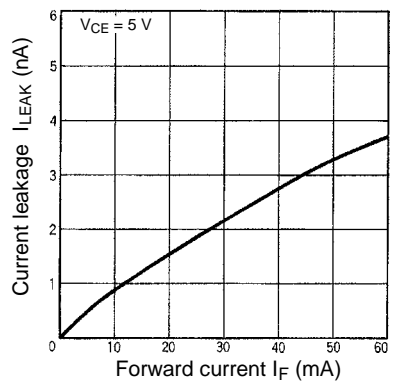

SENSING DISTANCE CHARACTERISTICS (TYPICAL)

EE-SY169

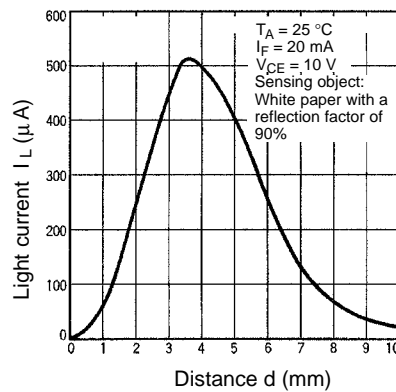

EE-SY169A

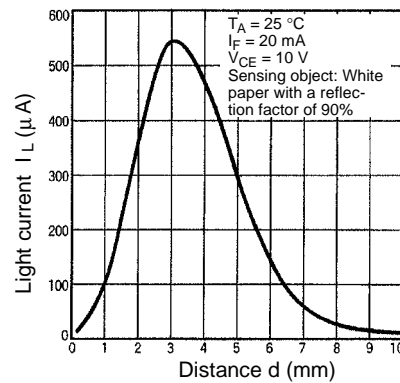

SWITCHING CHARACTERISTICS (RISING TIME) (TYPICAL)

EE-SY169

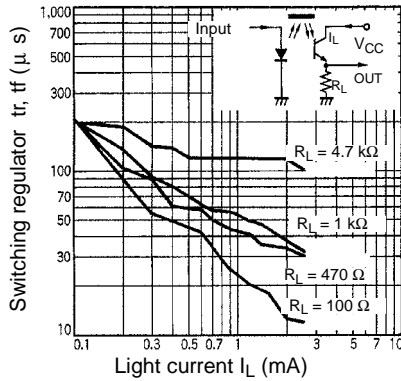

SENSING ANGLE CHARACTERISTICS (TYPICAL)

EE-SY169

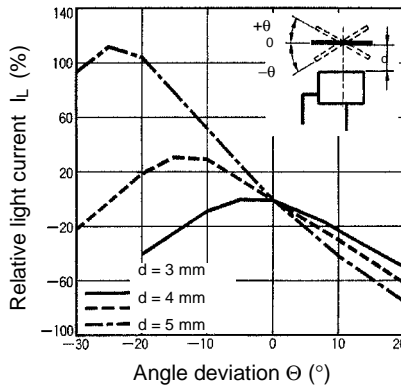

EE-SY169A

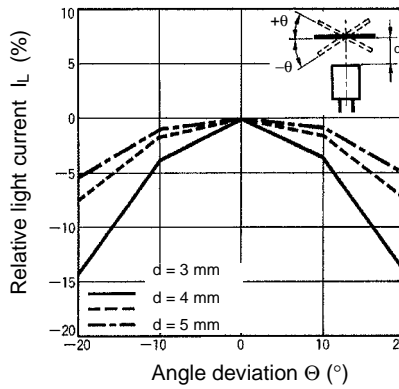

Dimensions

Unit: mm (inch)

EE-SY169/169A

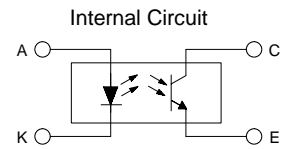
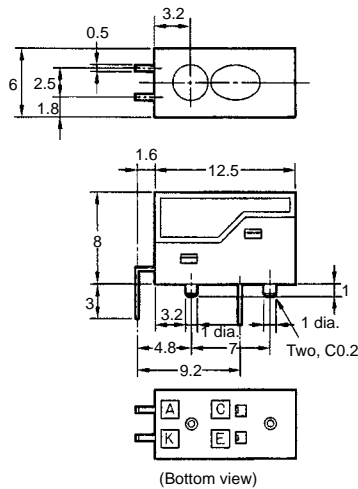
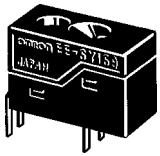

Terminal No.	Name
A	Anode
K	Cathode
C	Collector
E	Emitter

Precautions

Refer to the Technical Information Section for general precautions.

NOTE: DIMENSIONS SHOWN ARE IN MILLIMETERS. To convert millimeters to inches divide by 25.4.

OMRON[®]

Omron Europe B.V. EMA-ISD, tel:+31 23 5681390, fax:+31 23 5681397, <http://www.eu.omron.com/ema>