



# Industrial DC/DC CONVERTER MGDI-10 Standard Input : 10W POWER

Industrial Grade ■

**2:1 Standard Input  
Single & Bi Outputs  
Metallic case - 1.500 VDC Isolation**

- Low profile : 0,33 " ( 8.5mm)
- Nominal power of 10 W without derating
- Wide temperature range : -40°C/+95°C case
- High efficiency up to 83 %
- Soft start
- Galvanic isolation 1.500 VDC
- Integrated LC EMI filter
- Permanent short circuit protection
- No optocoupler for high reliability



## 1-General

The MGDI-10 series is a full family of DC/DC power modules designed for use in distributed power architecture and are particularly suitable for mobile or ground fixed applications in transportation, industry and télécommunication areas. These modules use a high frequency fixed switching technic at 500 KHz providing excellent reliability, low noise characteristics, high power density and a low profile package. Standard models are available with nominal input voltages as 5, 12, or 24 volts in range of 4,5-5,5, 9-18 or 18-36 volts. The series include single and bi output voltage choices of 3,3, 5, 12, 15, +/-5, +/-12 or +/-15 volts.

No external heatsink is required for the MGDI-10 series to supply 10W output power over the case temperature range of -40°C up to 95°C. The MGDI-10 series is designed in conformity with safety standards EN60950 and UL1950.

All the modules are designed with LC network filters to minimize reflected input current ripple and output voltage ripple according to EN55022 and FCC Part 15J standard.

The modules include a soft-start, and a permanent short circuit protection to ensure efficient module protection. The soft-start allows current limitation and eliminates inrush current during start-up. The short circuit protection completely protects the modules against short-circuits of any duration by a shut-down and restores to normal when the overload is removed.

The design has been carried out with surface mount components and is manufactured in a fully automated process to guarantee high quality. Each module is tested and burned in with a GAIA converter automated test equipment.

5

## 2-Product Selection

Single output model : MGDSI-10-  -

Bi output model : MGDBI-10-  -

### Input Voltage Range

#### Permanent

C : 4,5-5,5 VDC  
F : 9-18 VDC  
I : 18-36 VDC

### Output

B : 3,3 VDC  
C : 5 VDC or +/-5VDC  
E : 12 VDC or +/-12VDC  
F : 15 VDC or +/-15VDC

## 2- Product Selection (continued)

Input range	Output	Current	Reference	Options
4.5-5.5 VDC	3,3 VDC	2 A	MGDSI-10-C-B	/
4.5-5.5 VDC	5 VDC	2 A	MGDSI-10-C-C	/
4.5-5.5 VDC	12 VDC	0,80 A	MGDSI-10-C-E	/
4.5-5.5 VDC	15 VDC	0,65 A	MGDSI-10-C-F	/
4.5-5.5 VDC	+/- 5 VDC	+/- 1 A	MGDBI-10-C-C	/
4.5-5.5 VDC	+/- 12 VDC	+/- 0,40 A	MGDBI-10-C-E	/
4.5-5.5 VDC	+/- 15 VDC	+/- 0,33 A	MGDBI-10-C-F	/
9-18 VDC	3,3 VDC	2 A	MGDSI-10-F-B	/
9-18 VDC	5 VDC	2 A	MGDSI-10-F-C	/
9-18 VDC	12 VDC	0.80 A	MGDSI-10-F-E	/
9-18 VDC	15 VDC	0.65 A	MGDSI-10-F-F	/
9-18 VDC	+/- 5 VDC	+/- 1 A	MGDBI-10-F-C	/
9-18 VDC	+/- 12 VDC	+/- 0.40 A	MGDBI-10-F-E	/
9-18 VDC	+/- 15 VDC	+/- 0.33 A	MGDBI-10-F-F	/
18-36 VDC	3,3 VDC	2 A	MGDSI-10-I-B	/
18-36 VDC	5 VDC	2 A	MGDSI-10-I-C	/
18-36 VDC	12 VDC	0.80 A	MGDSI-10-I-E	/
18-36 VDC	15 VDC	0.65 A	MGDSI-10-I-F	/
18-36 VDC	+/- 5 VDC	+/- 1 A	MGDBI-10-I-C	/
18-36 VDC	+/- 12 VDC	+/- 0.40 A	MGDBI-10-I-E	/
18-36 VDC	+/- 15 VDC	+/- 0.33 A	MGDBI-10-I-F	/

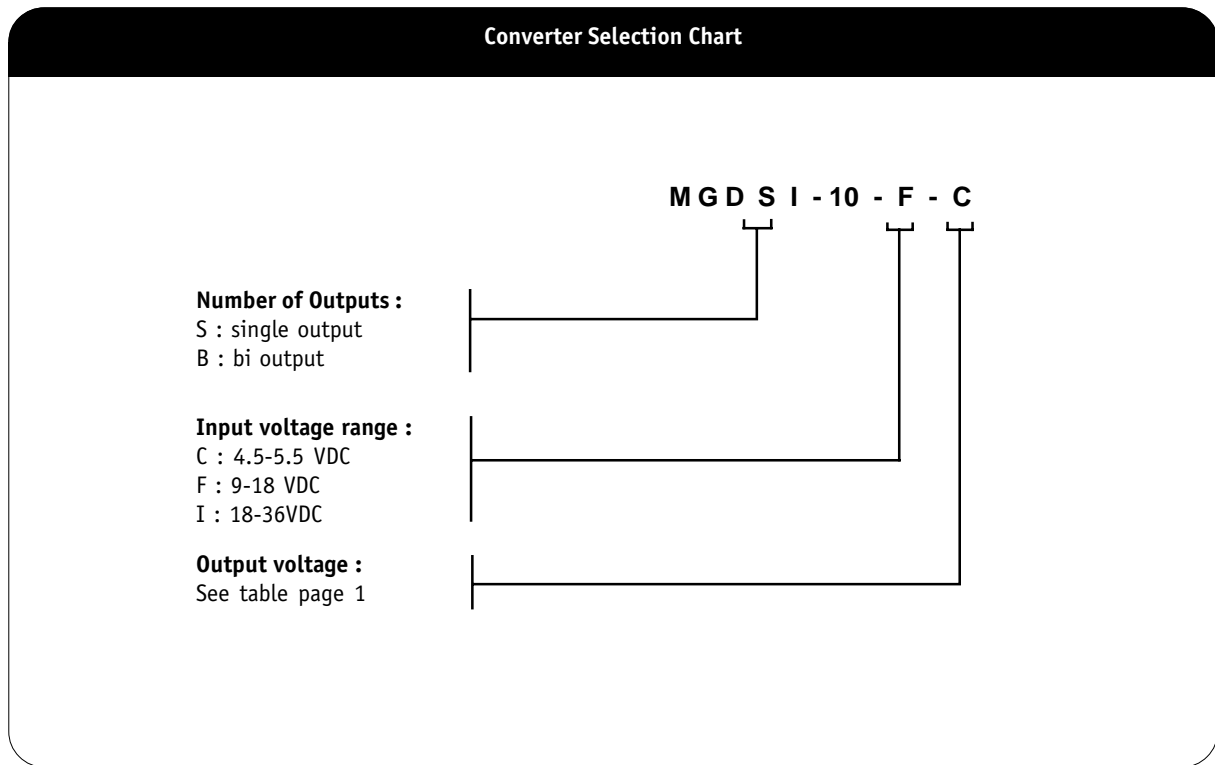

## 3- Electrical Specifications

Data are valid at +25°C, unless otherwise specified.

Parameter	Conditions	Limit or typical	Units	Single Output MGDSI- 10			
				10 - C	10 - F	10 - I	
<b>Input</b>							
Nominal input voltage	Full temperature range	Nominal	VDC	5	15	24	
Permanent input voltage range (Ui)	Full temperature range	Min. - Max.	VDC	4,5- 5,5	9- 18	18- 36	
Start up time	Ui nominal Nominal output Full load : resistive	Maximum	ms	30	30	30	
Reflected ripple current	Ui nominal, full load at switching freq. BW = 20MHz Decoupling capacitor 10µF	Maximum	mApp	50	50	30	
Input current in short circuit mode (Average)	Ui nominal Short-circuit	Maximum	mA	50	30	30	
No load input current	Ui nominal No load	Maximum	mA	50	30	30	
<b>Output</b>							
Output voltage *	Full temperature range Ui min. to max. 75% load	Nominal	VDC	3,3	3,3	3,3	
		Nominal	VDC	5	5	5	
		Nominal	VDC	12	12	12	
		Nominal	VDC	15	15	15	
Set Point accuracy	Ambient temperature : +25°C Ui nominal, 75% load	Maximum	%	+/- 2	+/- 2	+/- 2	
Output power	Full temperature range Ui min. to max.	Maximum	W	10	10	10	
Output current	Full temperature range Ui min. to max.	Maximum	mA	3,3V output	2.000	2.000	2.000
5V output				2.000	2.000	2.000	
12V output				800	800	800	
15V output				650	650	650	
Ripple output voltage **	Ui nominal Full load BW = 20MHz	Maximum	mVpp	3,3V and 5V output	50	50	50
12V output				100	100	100	
15V output				150	150	150	
Line regulation	Ui min. to max. Full load	Maximum	%	+/- 1	+/- 1	+/- 1	
Load regulation	Ui nominal 25% to full load	Maximum	%	+/- 2,5	+/- 2,5	+/- 2,5	
Efficiency	Ui nominal Full load	Typical	%	77	82	83	
Maximum admissible Capacity load	Ui nominal Full load Per output	Maximum	µF	3,3V and 5V output	1.000	1.000	1.000
12V and 15V output				330	330	330	

Note \* : For proper operation the MGDI-10 module requires to install a 22µF chemical or tantalum capacitance across output terminals.

Note \*\* : The ripple output voltage is the periodic AC component imposed on the output voltage, an aperiodic and random component (noise) has also to be considered. This noise can be reduced by adding an external capacitance (typically 10nF/rated voltage depending on isolation requirement) connected between the pin Gin and the pin Gout of the converter. This capacitance should be layed-out as close as possible from the converter.

## 3- Electrical Specifications (continued)

Data are valid at +25°C, unless otherwise specified.

Parameter	Conditions	Limit or typical	Units	Bi Output MGDBI- 10		
				10 - C	10 - F	10 - I
<b>Input</b>						
Nominal input voltage	Full temperature range	Nominal	VDC	5	15	24
Permanent input voltage range (Ui)	Full temperature range	Min. - Max.	VDC	4,5- 5,5	9- 18	18- 36
Start up time	Ui nominal Nominal output Full load : resistive	Maximum	ms	30	30	30
Reflected ripple current	Ui nominal, full load at switching freq. BW = 20MHz Decoupling capacitor 10µF	Maximum	mApp	50	50	30
Input current in short circuit mode (Average)	Ui nominal Short-circuit	Maximum	mA	50	30	30
No load input current	Ui nominal No load	Maximum	mA	50	30	30
<b>Output</b>						
Output voltage *	Full temperature range	Nominal	VDC	+/- 5	+/- 5	+/- 5
	Ui min. to max.	Nominal	VDC	+/- 12	+/- 12	+/- 12
	75% load	Nominal	VDC	+/- 15	+/- 15	+/- 15
Set Point accuracy	Ambient temperature : +25°C Ui nominal, 75% load	Maximum	%	+/- 2	+/- 2	+/- 2
Output power	Full temperature range Ui min. to max.	Maximum	W	+/- 5	+/- 5	+/- 5
Output current	Full temperature range Ui min. to max.	Maximum	mA	+/- 1.000	+/- 1.000	+/- 1.000
+/- 5V output		Maximum	mA	+/- 400	+/- 400	+/- 400
+/- 12V output		Maximum	mA	+/- 330	+/- 330	+/- 330
+/- 15V output						
Ripple output voltage **						
5V output	Ui nominal	Maximum	mVpp	50	50	50
12V output	Full load	Maximum	mVpp	100	100	100
15V output	BW = 20MHz	Maximum	mVpp	150	150	150
Line regulation	Ui min. to max. Full load	Maximum	%	+/- 1	+/- 1	+/- 1
Load regulation	Ui nominal 25% to full load	Maximum	%	+/- 2,5	+/- 2,5	+/- 2,5
Cross load output regulation	Ui nominal + Vout nominal load - Vout from 25% to full load	Maximum	%	+/- 0,5	+/- 0,5	+/- 0,5
Efficiency	Ui nominal Full load	Typical	%	77	82	83
Maximum admissible Capacity load	Ui nominal					
3,3V and 5V output	Full load	Maximum	µF	470	470	470
12V and 15V output	Per output	Maximum	µF	100	100	100

Note \* : For proper operation the MGDI-10 module requires to install a 22µF chemical or tantalum capacitance across output terminals.

Note \*\* : The ripple output voltage is the periodic AC component imposed on the output voltage, an aperiodic and random component (noise) has also to be considered. This noise can be reduced by adding an external capacitance (typically 10nF/rated voltage depending on isolation requirement) connected between the pin Gin and the pin Gout of the converter. This capacitance should be layed-out as close as possible from the converter.

## 4- Functional Characteristics

Characteristics	Conditions	Limit or typical	Performances
Electric strength test voltage	Input to output	Minimum	1,500 VDC / 1 min
Isolation resistance	500 VDC	Minimum	100 Mohm
Short circuit protection	Short circuit	Auto restart	Permanent
Switching frequency	No load to full load	Nominal	480 KHz

## 5- Thermal Characteristics

Characteristics	Conditions	Limit or typical	Performances
Operating ambient temperature range at full load	Ambient temperature *	Minimum Maximum	- 40°C + 71°C
Operating case temperature range at full load	Case temperature	Minimum Maximum	- 40°C + 95°C
Storage temperature range	Non functioning	Minimum Maximum	- 40°C + 105°C

\* TNote \*: The upper temperature range depends on configuration, the user must assure a max. case temperature of + 95°C (See Application Notes : Ambient versus case temperature).

## 6- Reliability Characteristics

Characteristics	Conditions	Temperature	Performances
Mean Time Between Failure (MTBF) According to MIL-HDBK-217F	Ground fixed (Gf)	Case at 40°C Case at 70°C	950.000 Hrs 380.000 Hrs

## 7- Environmental Qualifications

Characteristics	Conditions	Severity	Test procedure
Humidity	Damp heat Temperature	93 % H.R 56 Days 40°C	IEC 68-2-3
Temperature cycling	Number of cycles Temperature change Transfert time / Steady state time	200 -40°C / +71°C 40 min. / 20 min.	IEC 68-2-14
Vibration (Sinusoidal)	Number of cycles Frequency Amplitude /acceleration	10 cycles in each axis 10 to 60 Hz/ 60 to 2000 Hz 0.7 mm/10 g	IEC 68-2-6
Shock (Half sinus)	Number of shocks Peak acceleration Duration	3 shocks in each axis 100 g 6 ms	IEC 68-2-27
Bump (Half sinus)	Number of bumps Duration Peak acceleration	2000 Bumps in each axis 6 ms 25 g	IEC 68-2-29
Electrical discharge susceptibility	Air discharge level 4 kV Contact discharge level 2kV Air discharge level 8 kV Contact discharge level 4 kV	sanction A sanction A sanction B sanction B	EN55082-2 with : EN61000-4-2 IEC 801-2
Electrical field susceptibility	Antenna at 1 m Wave form : AM modulated 80 %, 1KHz Test : 26 MHz to 1 GHz	Value 10 V/m	EN55082-2 with : EN61000-4-3 IEC801-3
Electrical fast transient susceptibility	Level 1 : 0.5 kV Level 3 : 2 kV	sanction A sanction B	EN55082-2 with : EN61000-4-4 IEC801-4

## 8- Electromagnetic Interference Qualifications

Electromagnetic interference requirements according to EN55022 class A and class B can be easily achieved as indicated in the following table :

Electromagnetic Interference according to EN55022			
Conducted noise emission	Configuration	With common mode capacitor $C_c = 10\text{nF}$ and input capacitor $C_i$	With common mode capacitor $C_c = 10\text{nF}$ and external filter
	Models		
	4,5-5,5V input models	Class A, $C_i = 10\mu\text{F} / 35\text{ V tantalum}$	Class B with KG9502
	9-18V input models	Class A, $C_i = 10\mu\text{F} / 35\text{ V tantalum}$	Class B with KG9502
	18-36V input models	Class A, $C_i = 4.7\mu\text{F} / 50\text{ V tantalum}$	Class B with KG9502
Radiated noise emission	Configuration	With common mode capacitor $C_c = 10\text{ nF}$	
	Models	Class B	
	All models		

### 8-1 Basic Configuration : Module Stand Alone with Input & Common Mode Noise Capacitance : EN55022 class A

Electromagnetic interference requirements according to EN55022 class A can be easily achieved by adding an external input capacitance ( $C_i$  Value explained in previous table) and a common mode noise capacitance

$C_c$  (10 nF/rated voltage depending on isolation requirement) connected between  $G_{in}$  and  $G_{out}$ . This common mode noise capacitance  $C_c$  should be laid-out as close as possible from the DC/DC converter.

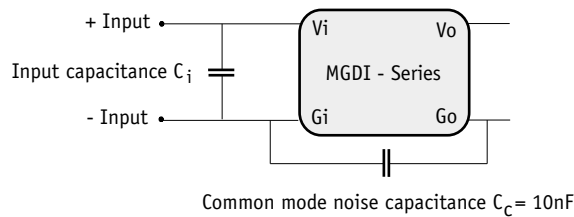

5

### 8-2 Configuration with Module and Front filter KG9502 and Common Mode Noise Capacitance : EN 55022 Class B

Electromagnetic interference requirements according to EN55022 class B can be easily achieved by adding an external input filter KG9502 consisting of 4 capacitances, a common mode choke, and a differential

mode inductance, together with a common mode noise capacitance (10 nF/rated voltage depending on isolation requirement) connected between  $G_{in}$  and  $G_{out}$ . Please consult KG9502 datasheet for further details.

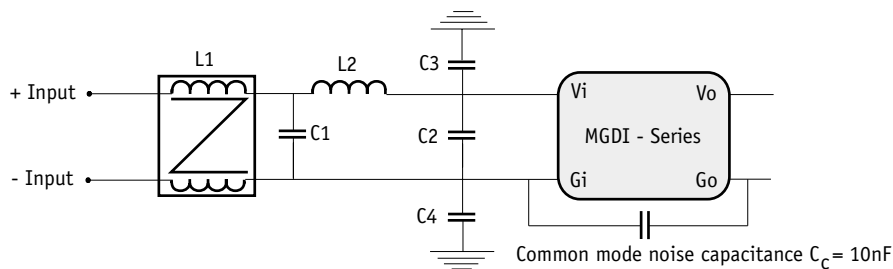

## 9- Application Notes

### 9-1 Short Circuit Protection

The short circuit protection device protects the modules against short circuits of any duration and restores the module to normal operation when the short circuit is removed.

### 9-2 Custom Output

Any of the bi output converters can be configured to produce output of 10V (+/-5 output models), 24V (+/-12V output models), or 30V (+/-15V output models) by connecting the load across the output (+) and the output (-) with either output grounded, and leaving the common pin floating.

### 9-3 Safety

The MGDI-10 series is recognized according to UL1950, EN60950 and EN41003. The isolation voltage is an operational insulation in accordance with EN60950 and the DC/DC module shall be installed in an end-use equipment.

### 9-4 Ambient versus Case Temperature

The MGDI-10 series operating **case** temperature at full load must not exceed 95°C. The maximum **ambient** temperature admissible for the DC/DC converter corresponding to the maximum operating case temperature depends on the ambient airflow, the unit mounting/orientation, the cooling features and the power dissipated. Thermal calculation shows two areas of operation :

- a normal operation area in a free natural ambient convection (grey area in the following graph),
- an area with cooling features (air flow or heatsink ) ensuring a maximum case temperature below 95°C at full load (white area in the following graph).

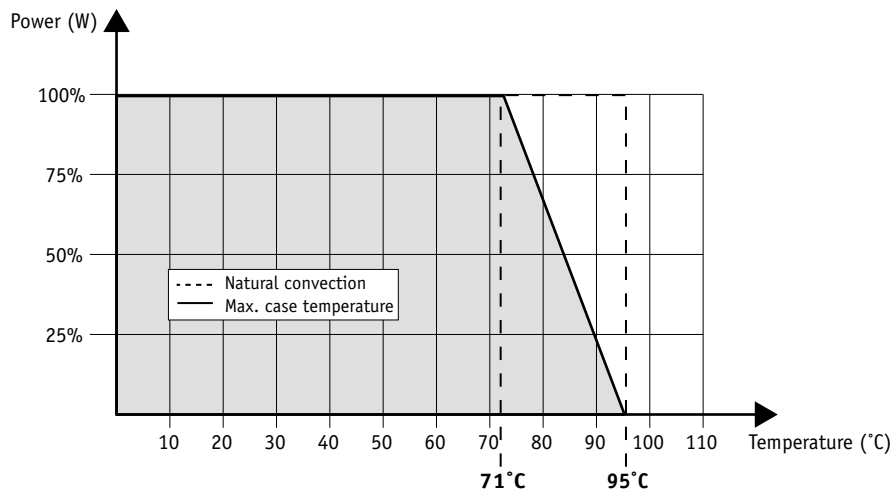

## 10- Dimensions

Dimensions are given in mm (inches). Tolerance : +/- 0,2 mm (+/- 0.01 ") unless otherwise indicated.  
 Weight : 20 grams (0.7 Ozs) max.

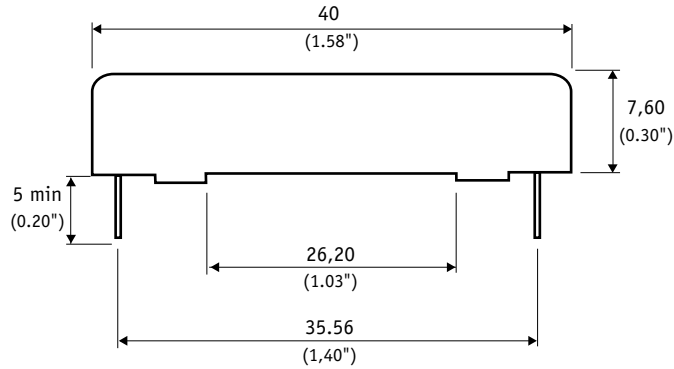

Pin dimensions : Ø 0,73 mm (0.03 ")

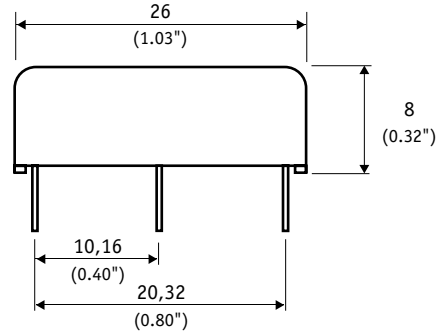

Metallic case black anodized coating solder plated pin

## 11- Product Marking

Upper face : Company logo, location of manufacturing.  
 Side face : Module reference, option, date code : year and week of manufacturing.

5

## 12- Connections

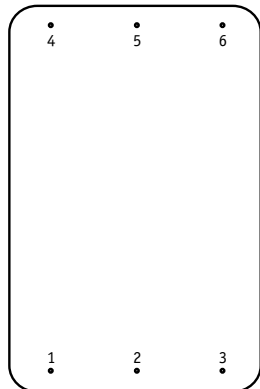

Bottom view

Pin	Bi Output	Single Output
1	+ Input (Vi)	+ Input (Vi)
2	No pin	No pin
3	- Input (Gi)	- Input (Gi)
4	Output + (+Vo)	Output (Vo)
5	Common (Go)	No pin
6	Output - (-Vo)	Common (Go)





For more detailed specifications and applications information, contact :

**International Headquarters**

Marketing and Sales department  
GAIA Converter - France  
Address : B.P. 14 - MERIGNAC - FRANCE  
Tel. : + (33)-5-57-92-12-80  
Fax : + (33)-5-57-92-12-89

**North American Headquarters**

GAIA Converter Canada, Inc  
Address : 6611 Thimens  
ST-LAURENT, QUEBEC - CANADA H4S 1W2  
Tel. : (514)-333-3169  
Fax : (514)-333-4519

Represented by :