

GPS Base Band LSI

Description

The CXD2932AGA-2 is a dedicated LSI for the GPS (Global Positioning System) satellite-based position measurement system.

This LSI contains a 32-bit RISC CPU, satellite tracking circuit, 2M-bit mask ROM, RAM, UART, interval timer, and others.

This LSI, used together with the RF LSI, enables the configuration of a 2-chip system capable of measuring its position anywhere on the globe.

Features

- 16-channel GPS receiver capable of simultaneously receiving 16 satellites
- Supports differential GPS
 - Conforms to RTCM SC-104 Ver. 2.1
 - Supports DARC
- All-in-view measurement
- Timer supporting GPS time
- 32-bit RISC CPU
- 256K-byte program ROM
- 40K-byte RAM
- Power management function
- 1PPS supported
- 2-channel UART
- 4-channel interval timer
- 16-bit general-purpose I/O port
- 12-bit successive approximation system A/D converter (4-channel analog switch)

Structure

Silicon gate CMOS IC

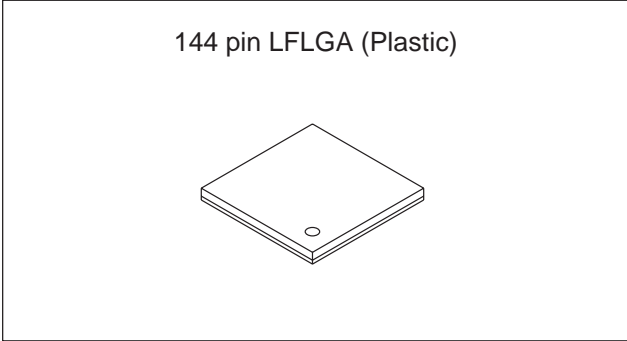

Absolute Maximum Ratings

- Supply voltage V_{DD} $V_{SS} - 0.5$ to 4.6 V
- Input voltage V_I $V_{SS} - 0.5$ to $V_{DD} + 0.5$ V
- Output voltage V_O $V_{SS} - 0.5$ to $V_{DD} + 0.5$ V
- Operating temperature
 - T_{opr} -40 to $+85$ °C
- Storage temperature
 - T_{stg} -50 to $+150$ °C

Recommended Operating Conditions

- Supply voltage V_{DD} 3.0 to 3.6 V
- Operating temperature
 - T_{opr} -40 to $+85$ °C

Input/Output Pin Capacitance

- Input capacitance C_{IN} 9 (Max.) pF
- Output capacitance C_{OUT} 11 (Max.) pF
- I/O capacitance $C_{I/O}$ 11 (Max.) pF

Sony reserves the right to change products and specifications without prior notice. This information does not convey any license by any implication or otherwise under any patents or other right. Application circuits shown, if any, are typical examples illustrating the operation of the devices. Sony cannot assume responsibility for any problems arising out of the use of these circuits.

Performance

- 16-channel GPS receiver
- 32-bit RISC CPU
- Receiver frequency: 1575.42MHz (L1 band, CA code)
- Reception sensitivity
 - Tracking sensitivity: -145dBm or less (typ.) when using the antenna of 25dBi , $\text{NF} = 2\text{dB}$ and the RF amplifier with the 25dB gain for the RF block
 - * Reference data using the Sony's reference board.
This value is not guaranteed, depending on the conditions.
- Time to First Fix (time until initial measurement after power-on)
 - Cold Start (without both ephemeris and almanac): 27 to 58s
 - Warm Start (without ephemeris with almanac): 23 to 45s
 - Hot Start (with both ephemeris and almanac): 6 to 17s
 - * Reference data with elevation angle of 5° or more and no interception environment on June, 2002.
Positioning time with 90% possibility.
These values are not guaranteed, depending on the conditions.
- Positioning accuracy
 - 2DRMS: approx. 5m
 - * Reference data with elevation angle of 5° or more and no interception environment on June, 2002.
This value is not guaranteed, depending on the conditions.
- Measurement data update time: 1s
- Communication format: Sony Binary
NMEA-0183
Customized NMEA (9600bps)
- All-in-view

Block Diagram

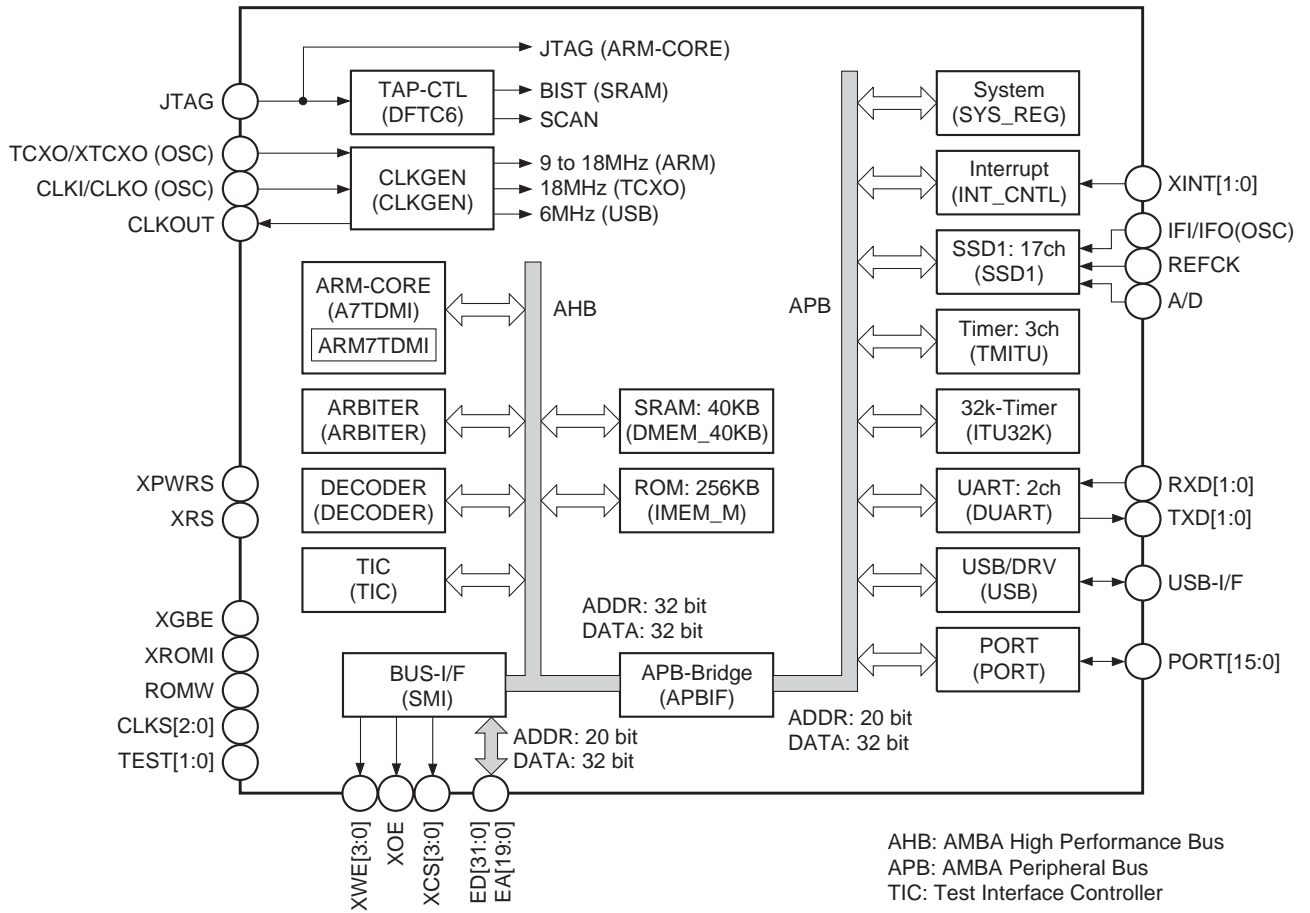

Pin Configuration (Top View)

70	67	64	62	59	58	55	54	51	50	47	45	42	39	34
XWE2	XINT1	XRS	GBE	CLKO	CLKI	CLKS0	Vdd1	Vss1	AVS3	AVD3	AVD1	VRB	VIN1	TDO
75	71	68	66	63	60	56	53	49	46	43	41	38	35	31
ROMW	XWE3	XWE0	Vdd2	XPWRS	Vss2	CLKS1	XTCXO	USBDP	AVS1	VRT	VIN3	VIN0	TMS	TRST
78	74	72	69	65	61	57	52	48	44	40	37	36	32	28
Vdd3	XROMI	Vss3	XWE1	XINT0	CLKOUT	CLKS2	TCXO	USBDM	AVS2	VIN2	AVD2	Vdd11	TCK	CCKO
81	77	73										33	30	26
ED4	ED1	XOE										TDI	REFCK	TEST1
83	79	76										29	27	23
ED6	ED2	ED0										Vss11	CCKI	IFI
86	82	80										25	24	22
ED8	ED5	ED3										TEST0	IFO	Vdd10
87	85	84										21	20	19
ED9	ED7	Vss4										RXD1	TXD1	RXD0
90	89	88										16	17	18
Vdd4	ED11	ED10										PORT14	PORT15	TXD0
91	92	93										12	13	15
ED12	ED13	ED14										PORT11	PORT12	Vss10
94	96	97										8	10	14
ED15	Vss5	ED17										Vdd9	PORT9	PORT13
95	99	101										4	7	11
ED16	ED19	ED21										PORT4	PORT7	PORT10
98	102	105										1	5	9
ED18	Vdd5	ED24										Vss9	PORT5	PORT8
100	104	108	109	112	116	120	124	129	133	137	141	144	2	6
ED20	ED23	Vss6	ED27	ED30	EA1	Vss7	EA8	EA12	EA15	EA19	XCS2	PORT1	PORT2	PORT6
103	107	110	113	115	118	121	125	128	132	135	138	140	143	3
ED22	ED26	ED28	ED31	EA0	EA3	EA5	EA9	EA11	Vss8	EA17	Vdd8	XCS1	PORT0	PORT3
106	111	114	117	119	122	123	126	127	130	131	134	136	139	142
ED25	ED29	Vdd6	EA2	EA4	EA6	EA7	Vdd7	EA10	EA13	EA14	EA16	EA18	XCS0	XCS3

Pin Description

Pin No.	Symbol	I/O	Description
1	V _{SS9}	—	V _{SS}
2	PORT2	I/O/Z	I/O port 2 (See the Application Circuit for setting.)
3	PORT3	I/O/Z	I/O port 3 (See the Application Circuit for setting.)
4	PORT4	I/O/Z	I/O port 4 (See the Application Circuit for setting.)
5	PORT5	I/O/Z	I/O port 5 (See the Application Circuit for setting.)
6	PORT6	I/O/Z	I/O port 6 (See the Application Circuit for setting.)
7	PORT7	I/O/Z	I/O port 7 (See the Application Circuit for setting.)
8	V _{DD9}	—	V _{DD}
9	PORT8	I/O/Z	I/O port 8 (See the Application Circuit for setting.)
10	PORT9	I/O/Z	I/O port 9 (See the Application Circuit for setting.)
11	PORT10	I/O/Z	I/O port 10 (See the Application Circuit for setting.)
12	PORT11	I/O/Z	I/O port 11 (See the Application Circuit for setting.)
13	PORT12	I/O/Z	I/O port 12 (See the Application Circuit for setting.)
14	PORT13	I/O/Z	I/O port 13 (See the Application Circuit for setting.)
15	V _{SS10}	—	V _{SS}
16	PORT14	I/O/Z	I/O port 14
17	PORT15	I/O/Z	I/O port 15
18	TXD0	O/Z	UART transmission data (CH0)
19	RXD0	I	UART reception data (CH0)
20	TXD1	O/Z	UART transmission data (CH1)
21	RXD1	I	UART reception data (CH1)
22	V _{DD10}	—	V _{DD}
23	IFI	I	IF signal binary conversion circuit
24	IFO	O	
25	TEST0	I	Test (Low level fixed)
26	TEST1	I	Test (Low level fixed)
27	CCKI	I	Timer oscillation circuit (32.768kHz ± 100ppm)
28	CCKO	O	
29	V _{SS11}	—	V _{SS}
30	REFCK	I	Test (Low level fixed)
31	TRST	I	Test (Open)
32	TCK	I	Test (Open)
33	TDI	I	Test (Open)
34	TDO	O/Z	Test
35	TMS	I	Test (Open)
36	V _{DD11}	—	V _{DD}
37	AVD2	—	A/D converter V _{DD}

Pin No.	Symbol	I/O	Description
38	VIN0	I	Analog input (CH0)
39	VIN1	I	Analog input (CH1)
40	VIN2	I	Analog input (CH2)
41	VIN3	I	Analog input (CH3)
42	VRB	I	Reference input (Bottom)
43	VRT	I	Reference input (Top)
44	AVS2	—	A/D converter V _{ss}
45	AVD1	—	PLL V _{DD}
46	AVS1	—	PLL V _{ss}
47	AVD3	—	USB V _{DD}
48	USBDM	I/O/Z	USB data + (Not supported in this IC. Pull down with 15kΩ)
49	USBDP	I/O/Z	USB data – (Not supported in this IC. Pull down with 15kΩ)
50	AVS3	—	USB V _{ss}
51	V _{ss1}	—	V _{ss}
52	TCXO	I	TCXO crystal oscillator (18.414MHz ± 3ppm)
53	XTCXO	O	
54	V _{DD1}	—	V _{DD}
55	CLKS0	I	CPU clock selection (CLKS2, CLKS1, CLKS0) = (0, 0, 1): 18.414MHz (TCXO) (CLKS2, CLKS1, CLKS0) = (0, 1, 0): 27.671MHz (TCXO × 1.5)
56	CLKS1	I	
57	CLKS2	I	
58	CLKI	I	CPU clock oscillator
59	CLKO	O	
60	V _{ss2}	—	V _{ss}
61	CLKOUT	O/Z	1PPS output
62	GBE	I	External bus enable (H-Active)
63	XPWRS	I	Oscillator enable (H-Active)
64	XRS	I	Reset (L-Active)
65	XINT0	I	External interruption 0 (L-Active)
66	V _{DD2}	—	V _{DD}
67	XINT1	I	External interruption 1 (L-Active)
68	XWE0	O	External expansion write signal 0
69	XWE1	O	External expansion write signal 1
70	XWE2	O	External expansion write signal 2
71	XWE3	O	External expansion write signal 3
72	V _{ss3}	—	V _{ss}
73	XOE	O	External expansion read signal
74	XROMI	I	Program area selection (Low: Internal / High: External)

Pin No.	Symbol	I/O	Description
75	ROMW	I	Test (Low level fixed)
76	ED0	I/O/Z	External expansion data 0
77	ED1	I/O/Z	External expansion data 1
78	V _{DD3}	—	V _{DD}
79	ED2	I/O/Z	External expansion data 2
80	ED3	I/O/Z	External expansion data 3
81	ED4	I/O/Z	External expansion data 4
82	ED5	I/O/Z	External expansion data 5
83	ED6	I/O/Z	External expansion data 6
84	V _{SS4}	—	V _{SS}
85	ED7	I/O/Z	External expansion data 7
86	ED8	I/O/Z	External expansion data 8
87	ED9	I/O/Z	External expansion data 9
88	ED10	I/O/Z	External expansion data 10
89	ED11	I/O/Z	External expansion data 11
90	V _{DD4}	—	V _{DD}
91	ED12	I/O/Z	External expansion data 12
92	ED13	I/O/Z	External expansion data 13
93	ED14	I/O/Z	External expansion data 14
94	ED15	I/O/Z	External expansion data 15
95	ED16	I/O/Z	External expansion data 16
96	V _{SS5}	—	V _{SS}
97	ED17	I/O/Z	External expansion data 17
98	ED18	I/O/Z	External expansion data 18
99	ED19	I/O/Z	External expansion data 19
100	ED20	I/O/Z	External expansion data 20
101	ED21	I/O/Z	External expansion data 21
102	V _{DD5}	—	V _{DD}
103	ED22	I/O/Z	External expansion data 22
104	ED23	I/O/Z	External expansion data 23
105	ED24	I/O/Z	External expansion data 24
106	ED25	I/O/Z	External expansion data 25
107	ED26	I/O/Z	External expansion data 26
108	V _{SS6}	—	V _{SS}
109	ED27	I/O/Z	External expansion data 27
110	ED28	I/O/Z	External expansion data 28
111	ED29	I/O/Z	External expansion data 29

Pin No.	Symbol	I/O	Description
112	ED30	I/O/Z	External expansion data 30
113	ED31	I/O/Z	External expansion data 31
114	V _{DD6}	—	V _{DD}
115	EA0	O/Z	External expansion address 0
116	EA1	O/Z	External expansion address 1
117	EA2	O/Z	External expansion address 2
118	EA3	O/Z	External expansion address 3
119	EA4	O/Z	External expansion address 4
120	V _{SS7}	—	V _{SS}
121	EA5	O/Z	External expansion address 5
122	EA6	O/Z	External expansion address 6
123	EA7	O/Z	External expansion address 7
124	EA8	O/Z	External expansion address 8
125	EA9	O/Z	External expansion address 9
126	V _{DD7}	—	V _{DD}
127	EA10	O/Z	External expansion address 10
128	EA11	O/Z	External expansion address 11
129	EA12	O/Z	External expansion address 12
130	EA13	O/Z	External expansion address 13
131	EA14	O/Z	External expansion address 14
132	V _{SS8}	—	V _{SS}
133	EA15	O/Z	External expansion address 15
134	EA16	O/Z	External expansion address 16
135	EA17	O/Z	External expansion address 17
136	EA18	O/Z	External expansion address 18
137	EA19	O/Z	External expansion address 19
138	V _{DD8}	—	V _{DD}
139	XCS0	O	External expansion chip select 0
140	XCS1	O	External expansion chip select 1
141	XCS2	O	External expansion chip select 2
142	XCS3	O	External expansion chip select 3
143	PORT0	I/O/Z	I/O port 0 (See the Application Circuit for setting.)
144	PORT1	I/O/Z	I/O port 1 (See the Application Circuit for setting.)

Analog Characteristics

(1) A/D Converter Characteristics

(AVD = 3.0 to 3.6V, Topr = -40 to +85°C)

Item	Symbol	Conditions	Min.	Typ.	Max.	Unit	Applicable pins
Resolution					12	Bit	
Channel				4		Ch	
Differential linearity error (DLE)		AVD = 3.0V	-1.0		+1.0	LSB	
Integral linearity error (ILE)			-1.0		+1.0	LSB	
Sampling time		f = 18.414MHz	5			μs	
Conversion time			15			μs	
Reference power (Top)	VRT		VRB		AVD	V	*1
Reference power (Bottom)	VRB		0		VRT	V	*2
Analog input power	VIN0-3		VRB		VRT	V	*3
Current consumption		AVD = 3.0V		5		mA	

Applicable pins

*1 Pin 43

*2 Pin 42

*3 Pins 38 to 41

(2) USB Characteristics

(AVD = 3.0 to 3.6V, Topr = -40 to +85°C)

Item	Symbol	Conditions	Min.	Typ.	Max.	Unit
Output impedance	Zdrv	—	28		43	Ω
Output voltage (Low)	VoL	RL = 1.5kΩ to 3.6V	—		0.3	V
Output voltage (High)	VoH	RL = 1.5kΩ to GND	2.8		3.6	V
Data rise delay time	Tr	CL = 50pF	75		—	ns
		CL = 350pF	—		300	ns
Data fall delay time	Tf	CL = 50pF	75		—	ns
		CL = 350pF			300	ns
Data delay time ratio	Tr/Tf	CL = 50pF or 350pF	0.8		1.2	—
Crossover voltage	Vcrs	CL = 50pF or 350pF	1.3		2.0	V
Current consumption (during operation)	Ica	CL = 50pF and Vcc = 3.6V	—		20	mA
Current consumption (during suspension)	Icb	Vcc = 3.6V	—		2	mA

Applicable pins

Pins 48, 49

DC Characteristics

(VDD = 3.0 to 3.6V, Topr = -40 to +85°C)

Item		Symbol	Conditions	Min.	Typ.	Max.	Unit	Applicable pins
Input voltage (1) (COMS level)	High level	V _{IH}		0.7V _{DD}			V	*1
	Low level	V _{IL}				0.2V _{DD}	V	
Input voltage (2) (5V interface)	High level	V _{IH}		0.7V _{DD}		5.5	V	*2
	Low level	V _{IL}				0.2V _{DD}	V	
Input voltage (3) (Schmitt)	High level	V _{IH}		0.7V _{DD}			V	*3
	Low level	V _{IL}				0.2V _{DD}	V	
Output voltage (1)	High level	V _{OH}	I _{OH} = -4.0mA	V _{DD} - 0.4			V	*4
	Low level	V _{OL}	I _{OL} = 4.0mA			0.4	V	
Output voltage (2)	High level	V _{OH}	I _{OH} = -8.0mA	V _{DD} - 0.4			V	*5
	Low level	V _{OL}	I _{OL} = 8.0mA			0.4	V	
Output voltage (3)	High level	V _{OH}	I _{OH} = -2.0mA	V _{DD} - 0.8			V	*6
	Low level	V _{OL}	I _{OL} = 8.0mA			0.4	V	
Output voltage (4) (5V interface)	High level	V _{OH}	I _{OH} = -2.0mA	V _{DD} - 0.8			V	*7
	Low level	V _{OL}	I _{OL} = 4.0mA			0.4	V	
Current consumption (During normal operation)	When GPS measurement	I _{cur}	3.0V, 18.414MHz		63		mA	
			3.0V, 27.671MHz		75		mA	
Current consumption (In backup mode)	When external timer used	I _{stb1}	3.0V		3	60	μA	
	When internal timer used	I _{stb2}	3.0V		5	100	μA	

Applicable pins

- *1 Pins 25, 26, 31 to 33, 35, 55 to 57, 74 to 77, 79 to 83, 85 to 89, 91 to 95, 97 to 101, 103 to 107, 109 to 113
- *2 Pins 2 to 7, 9 to 14, 16, 17, 19, 21, 30, 62, 65, 67, 143, 144 (Use the resistor of 4.7kΩ or less when the pull-down is performed.)
- *3 Pins 63, 64
- *4 Pins 34, 61
- *5 Pins 115 to 119, 121 to 125, 133 to 137, 139 to 142, 68 to 71, 73, 76, 77, 79 to 83, 85 to 89, 91 to 95, 97 to 101, 103 to 107, 109 to 113
- *6 Pins 2 to 7, 9 to 14, 16, 17, 143, 144
- *7 Pins 18, 20

AC Characteristics

(1) External Memory Read Timing

(V_{DD} = 3.0 to 3.6V, CL = 40pF, Topr = -40 to +85°C, CPU clock = 18.4MIPS)

Item	Symbol	Min.	Typ.	Max.	Unit
Read cycle time (0WAIT)*1	Trcy0		54		ns
Read cycle time (1WAIT)*1	Trcy1		108		ns
Read cycle time (2WAIT)*1	Trcy2		162		ns
Read cycle time (3WAIT)*1	Trcy3		216		ns
Address delay time	Tca	0		4	ns
Read signal fall delay time	Tcfo	2		10	ns
Read signal rise delay time	Tcro	2		10	ns
Read data setup time	Tds	22			ns
Read data hold time	Tdh			0	ns

*1 0WAIT (normal), 1 to 3WAIT (settable according to the program)

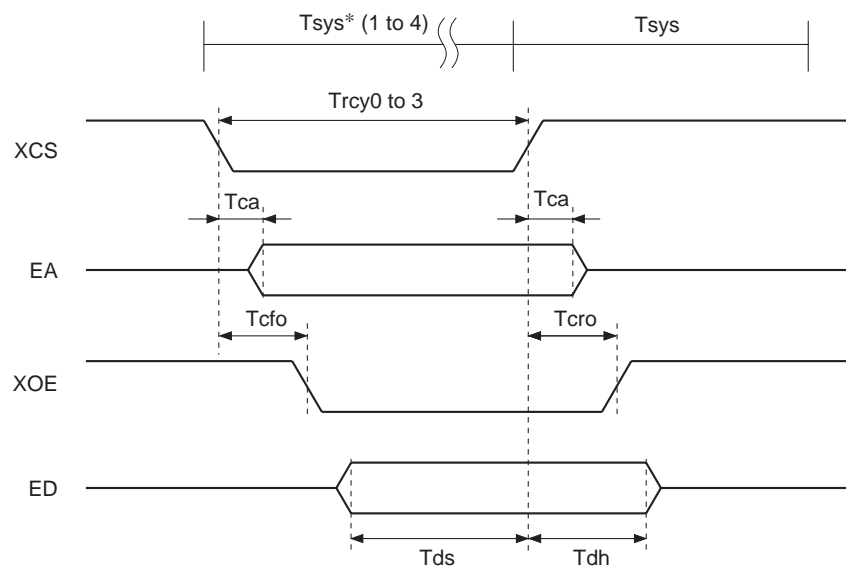

* Tsys: CPU clock cycle

(2) External Memory Write Timing

(V_{DD} = 3.0 to 3.6V, CL = 40pF, Topr = -40 to +85°C, CPU clock = 18.4MIPS)

Item	Symbol	Min.	Typ.	Max.	Unit
Write cycle time (0WAIT)*1	Twcy0		162		ns
Write cycle time (1WAIT)*1	Twcy1		216		ns
Write cycle time (2WAIT)*1	Twcy2		270		ns
Write cycle time (3WAIT)*1	Twcy3		324		ns
Address delay time	Tca	0		4	ns
Write signal fall delay time	Tcfo	2		6	ns
Write signal rise delay time	Tcro	2		8	ns
Write data setup time	Tds	2		15	ns
Write data hold time	Tdh	2		10	ns

*1 0WAIT (normal), 1 to 3WAIT (settable according to the program)

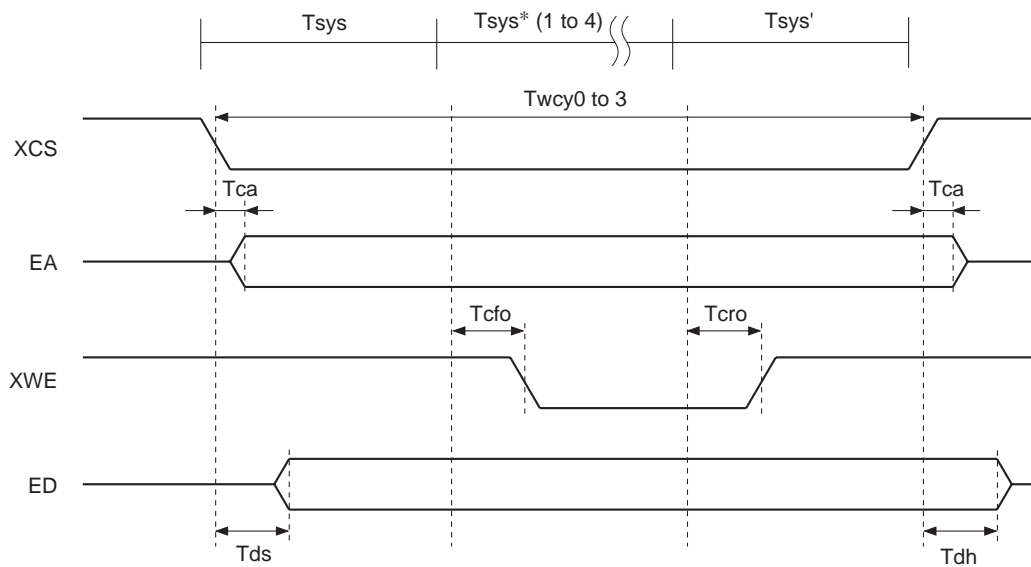

* Tsys: CPU clock cycle

Backup Mode

When the power supply of the GPS receiver system is off (XPWRS = low: the external pull-down is necessary) and the reset state (XRS = low) is established, the device goes into the low power consumption state (backup mode) where the all oscillators except for the timer stop. The whole internal memory status at this time is retained and the Hot Start/Warm Start can be achieved. In order to cancel this mode, set the XRS pin to high after XPWRS is set to high and then the oscillation stabilization time and the PLL lock-in time are waited. (Normal operation / reset : $V_{DD} = 3.0$ to $3.6V$, backup mode : $V_{DD} = 2.0$ to $3.6V$)

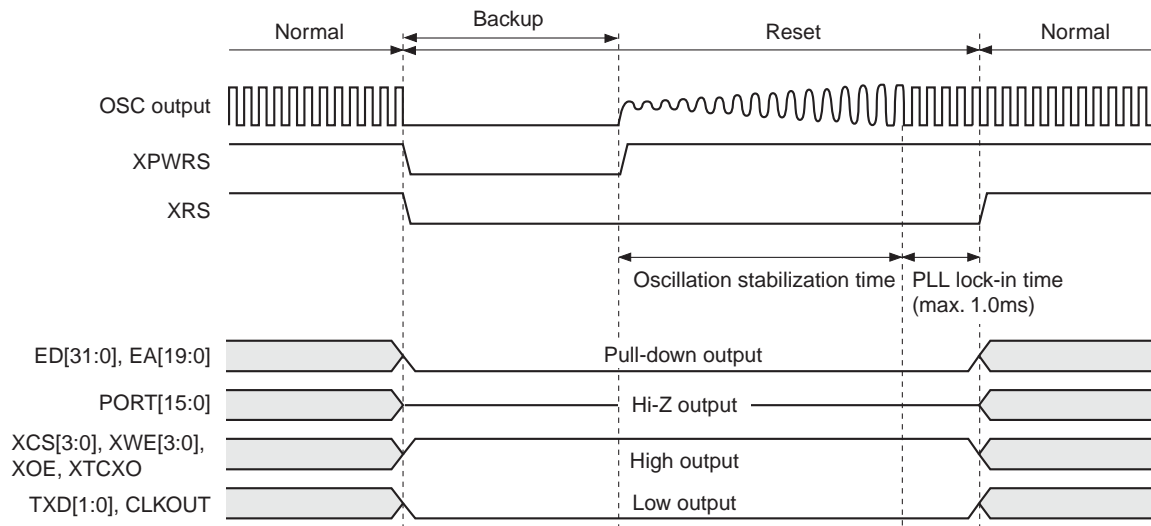

Initialization Setting

The device initialization is started by setting the reset pin (XRS) to low level. The timing should satisfy the conditions noted below.

(1) During power-on ($V_{DD} = 3.0$ to $3.6V$, $T_{opr} = -40$ to $+85^{\circ}C$)

XPWRS should rise simultaneously with the power supply. XRS should rise 100ms or more after the power supply and XPWRS have risen.

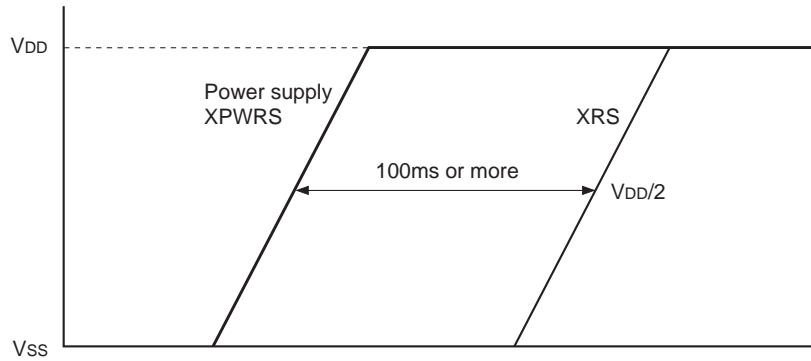

(2) Initialization during operation ($V_{DD} = 3.0$ to $3.6V$, $T_{opr} = -40$ to $+85^{\circ}C$)

The internal registers can be initialized during operation by setting the XRS signal to low level for 100 μ s or more. Keep the XPWRS signal at high level at this time. (The internal memory value is held.)

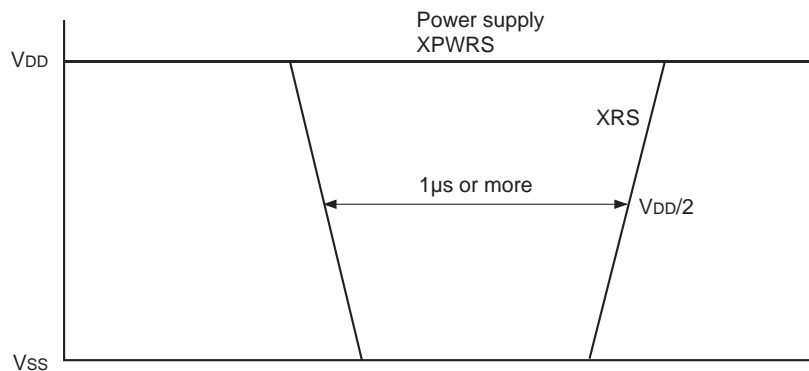

Application Notes

The constants shown in the circuits below are the examples, and do not guarantee the circuit operation.

(1) TCXO input

- (a) When inputting the binary-converted signal
The TCXO input signal should be 18.414MHz ± 3ppm.

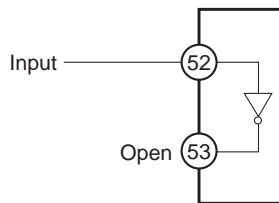

- (b) When performing the self-oscillation with the TCXO and XTCXO pins
The TCXO input signal should be 18.414MHz ± 3ppm.
For inputting the signal which is not binary converted, the signal should go through the DC cut capacitor.

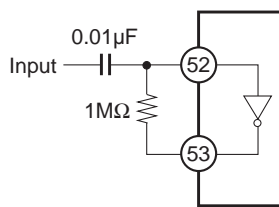

(2) CPU clock generation

- (a) CPU clock selector
The CLKS2, CLKS1 and CLKS0 pins are used to select that the TCXO clock is used or that the self-oscillation is performed with the CLKI and CLKO pins. Set the CLKI pin to low when the TCXO clock is used. (CLKS[2:0] = 001: recommendation)

CLKS[2:0]	CLKI, CLKO	CPU frequency
001	—	TCXO × 1.0 (18.414MHz)
010	—	TCXO × 1.5 (27.671MHz)
101	18 to 27MHz	CLKI × 1.0 (18 to 27MHz)
110	12 to 18MHz	CLKI × 1.5 (18 to 27MHz)

- (b) When performing the self-oscillation with the CLKI and CLKO pins
The crystal oscillator frequency should be within the values shown above.

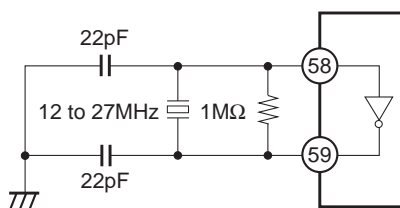

(3) Timer clock setting

When using the real-time clock (RTC) circuit in the device, connect the crystal oscillator of 32.768kHz \pm 100ppm to the CCKI and CCKO pins. When using the external RTC circuit, set the CCKI pin to the low level. See the Port setting for the RTC internal/external selection.

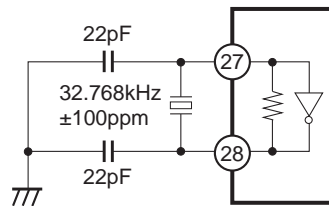

(4) IF signal input

This device's IF signal supports only 1.023MHz. When the signal which is not binary-converted is input, the signal should go through the DC cut capacitor.

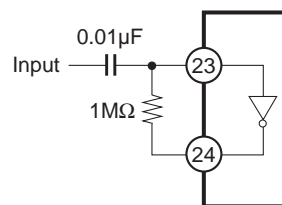

(5) Serial input/output communication system

See the corresponding data sheet for communication because the communication specification differs according to the communication format. See the Port setting for the communication format selection.

The transmission data (TXD0 and TXD1) amplitude is 0.4V or less for the low level and $V_{DD} - 0.4V$ or more for the high level. When the LSI and others connected to this operate at 5V and the CMOS level input is used, convert 3V to 5V for input.

(6) Port setting

When the power turns on or initialization setting is performed by the reset input, the system starts operation according to the selected port setting. Perform initialization after the setting is changed because the setting can not be changed during operation.

Port	I/O		Description
	For reset	For operation	
0	I	I	Test pin (Low = Normal mode)
1	I	I	Communication format selection PORT[2:1] = (00: Sony Binary, 01: NMEA4800, 10: NMEA9600, 11: Unused)
2	I	I	
3	I	I	RTC selection (High = Internal / Low = External)
4	I	I	Test pin (High = Normal mode)
5	I	I	Test pin (Low = Normal mode)
6	I	O	Unused
7	I	O	Unused
8	I	O	Unused
9	I	I	Antenna sense (Low = Disable / High = Enable)
10	I	O	Antenna shutdown (High = Cut)
11	I	I	Test pin (Low = Normal mode)
12	I	O	Unused
13	I	I/O	RTC SIO (Leave open when the internal RTC is selected.)
14	I	O	RTC SCL (Leave open when the internal RTC is selected.)
15	I	O	RTC CE (Leave open when the internal RTC is selected.)

(7) A/D setting

The antenna sense function can be realized by connecting the antenna power supply of the GPS receiver to the A/D channel pins shown below. See the Application Circuit for the resistance value and others. See the Port setting for the antenna sense function disable/enable selection.

VIN	I/O		Description
	For reset	For operation	
0	I	I	Antenna power supply (before current value detection resistor)
1	I	I	Antenna power supply (after current value detection resistor)
2	I	I	Test pin (Low level fixed)
3	I	I	Test pin (Low level fixed)

Application Circuit

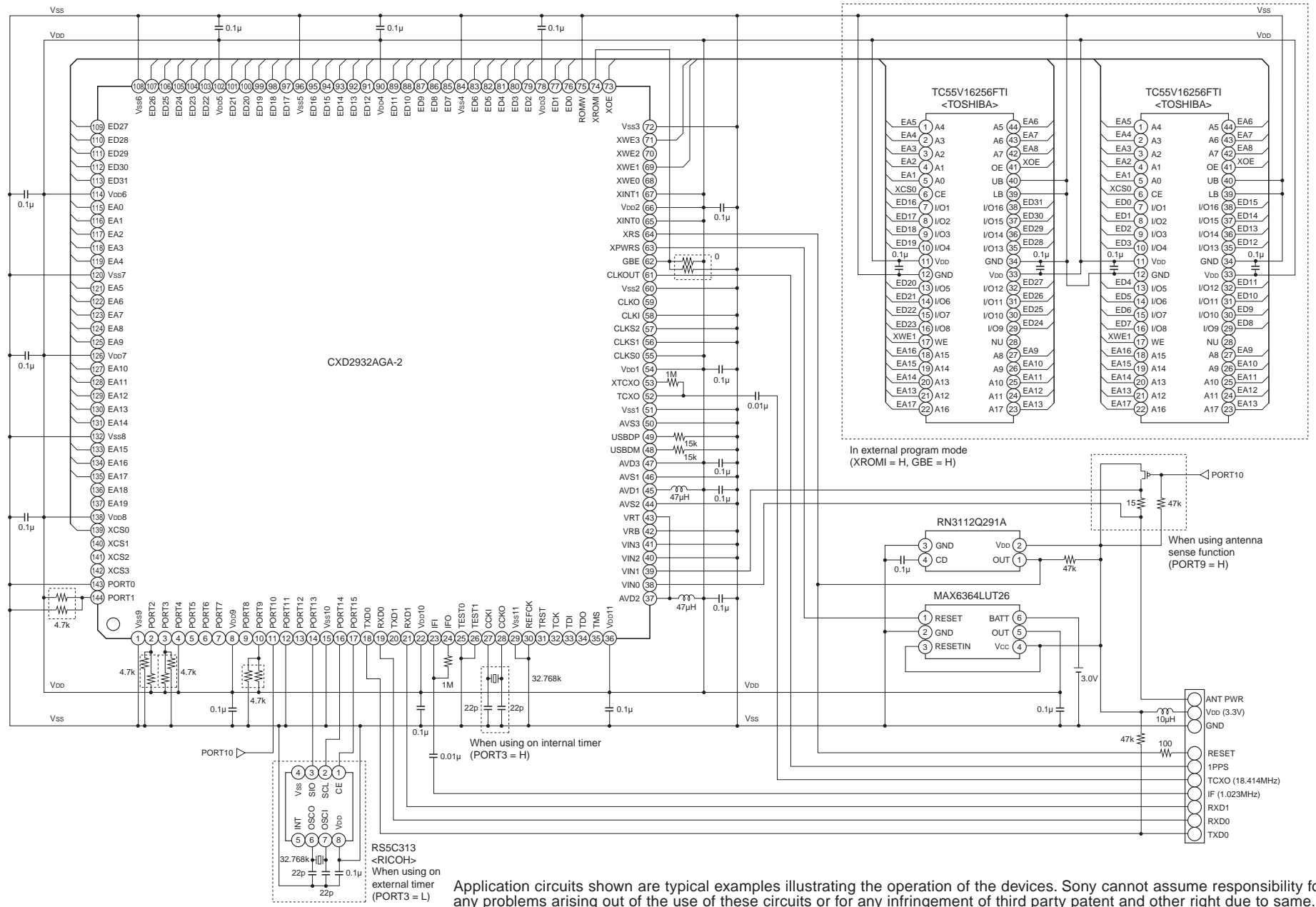

Application circuits shown are typical examples illustrating the operation of the devices. Sony cannot assume responsibility for any problems arising out of the use of these circuits or for any infringement of third party patent and other right due to same.

Package Outline Unit: mm

144PIN LFLGA

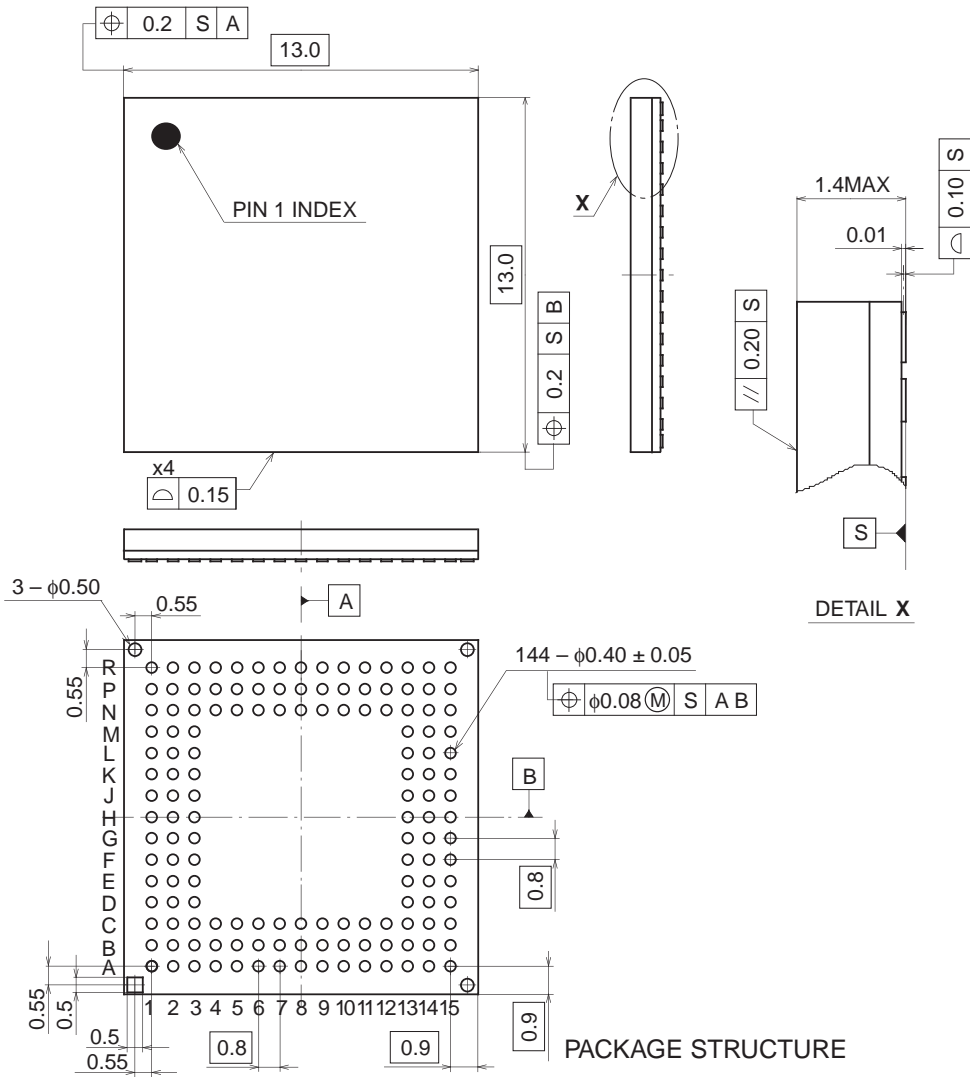

PACKAGE STRUCTURE

SONY CODE	LFLGA-144P-01
EIAJ CODE	P-LFLGA144-13x13-0.8
JEDEC CODE	—

PACKAGE MATERIAL	ORGANIC SUBSTRATE
TERMINAL TREATMENT	NICKEL & GOLD PLATING
TERMINAL MATERIAL	COPPER
PACKAGE MASS	0.5g