

TRENCH GENFET®

N-Channel Enhancement-Mode MOSFET

V<sub>DS</sub> 30V R<sub>DS(ON)</sub> 28mΩ I<sub>D</sub> 7A

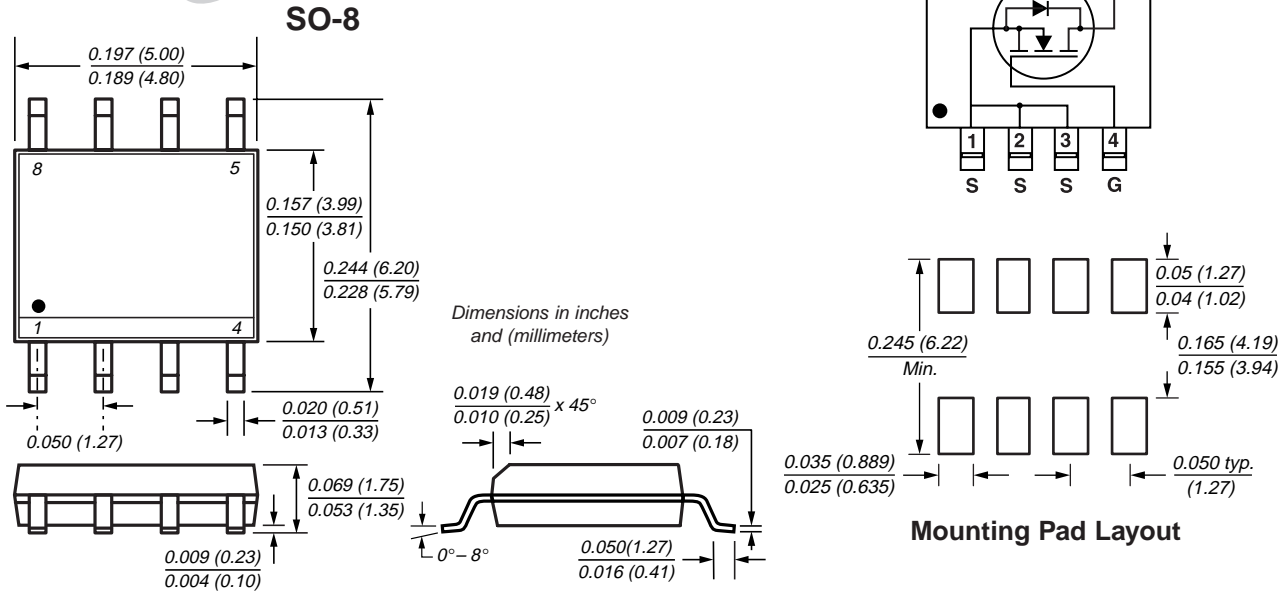

Mechanical Data

**Case:** SO-8 molded plastic body  
**Terminals:** Leads solderable per MIL-STD-750, Method 2026  
**High temperature soldering guaranteed:** 250°C/10 seconds at terminals  
**Mounting Position:** Any **Weight:** 0.5g

Features

- Advanced Trench Process Technology
- High Density Cell Design for Ultra Low On-Resistance
- Specially Designed for Low Voltage DC/DC Converters
- Fast Switching for High Efficiency

Maximum Ratings and Thermal Characteristics (T<sub>A</sub> = 25°C unless otherwise noted)

Parameter	Symbol	Limit	Unit
Drain-Source Voltage	V <sub>DS</sub>	30	V
Gate-Source Voltage	V <sub>GS</sub>	±20	
Continuous Drain Current T <sub>J</sub> = 150°C <sup>(1)</sup>	I <sub>D</sub>	T <sub>A</sub> = 25°C 7	A
		T <sub>A</sub> = 70°C 5.8	
Pulsed Drain Current	I <sub>DM</sub>	30	
Continuous Source Current (Diode Conduction) <sup>(1)</sup>	I <sub>S</sub>	2.3	
Maximum Power Dissipation <sup>(1)</sup>	P <sub>D</sub>	T <sub>A</sub> = 25°C 2.5	W
		T <sub>A</sub> = 70°C 1.6	
Operating Junction and Storage Temperature Range	T <sub>J</sub> , T <sub>stg</sub>	-55 to 150	°C
Maximum Junction-to-Ambient <sup>(1)</sup> Thermal Resistance	R <sub>θJA</sub>	50	°C/W

Notes: (1) Surface mounted on FR4 board, t ≤ 10 sec.

N-Channel Enhancement-Mode MOSFET

Electrical Characteristics (T<sub>J</sub> = 25°C unless otherwise noted)

Parameter	Symbol	Test Condition	Min	Typ	Max	Unit
<b>Static</b>						
Drain-Source Breakdown Voltage	BV <sub>DSS</sub>	V <sub>GS</sub> = 0V, I <sub>D</sub> = 250μA	30	–	–	V
Gate Threshold Voltage	V <sub>GS(th)</sub>	V <sub>DS</sub> = V <sub>GS</sub> , I <sub>D</sub> = 250μA	1	–	3	V
Gate-Body Leakage	I <sub>GSS</sub>	V <sub>GS</sub> = ±20V, V <sub>DS</sub> = 0V	–	–	±100	nA
Zero Gate Voltage Drain Current	I <sub>DSS</sub>	V <sub>DS</sub> = 30V, V <sub>GS</sub> = 0V	–	–	1	μA
		V <sub>DS</sub> = 30V, V <sub>GS</sub> = 0V, T <sub>J</sub> = 55°C	–	–	5	
On-State Drain Current <sup>(1)</sup>	I <sub>D(on)</sub>	V <sub>DS</sub> ≥ 5V, V <sub>GS</sub> = 10V	30	–	–	A
Drain-Source On-State Resistance <sup>(1)</sup>	R <sub>DS(on)</sub>	V <sub>GS</sub> = 10V, I <sub>D</sub> = 7A	–	20	28	mΩ
		V <sub>GS</sub> = 4.5V, I <sub>D</sub> = 3.5A	–	29	42	
Forward Transconductance <sup>(1)</sup>	g <sub>fs</sub>	V <sub>DS</sub> = 15V, I <sub>D</sub> = 7A	–	16	–	S
<b>Dynamic</b>						
Total Gate Charge	Q <sub>g</sub>	V <sub>DS</sub> = 15V, I <sub>D</sub> = 2A V <sub>GS</sub> = 10V	–	16	23	nC
Gate-Source Charge	Q <sub>gs</sub>		–	2.2	–	
Gate-Drain Charge	Q <sub>gd</sub>		–	2.4	–	
Turn-On Delay Time	t <sub>d(on)</sub>	V <sub>DD</sub> = 15V, I <sub>D</sub> = 1A V <sub>GEN</sub> = 10V, R <sub>G</sub> = 6Ω R <sub>L</sub> = 15Ω	–	6	12	ns
Turn-On Rise Time	t <sub>r</sub>		–	5	10	
Turn-Off Delay Time	t <sub>d(off)</sub>		–	25	37	
Turn-Off Fall Time	t <sub>f</sub>		–	7	14	
Input Capacitance	C <sub>iss</sub>	V <sub>DS</sub> = 15V	–	810	–	pF
Output Capacitance	C <sub>oss</sub>	V <sub>GS</sub> = 0V	–	150	–	
Reverse Transfer Capacitance	C <sub>rss</sub>	f = 1.0MHz	–	75	–	
<b>Source-Drain Diode</b>						
Diode Forward Voltage <sup>(1)</sup>	V <sub>SD</sub>	I <sub>S</sub> = 2A, V <sub>GS</sub> = 0V	–	0.75	1.3	V

Notes: (1) Pulse test; pulse width ≤ 300 μs, duty cycle ≤ 2%

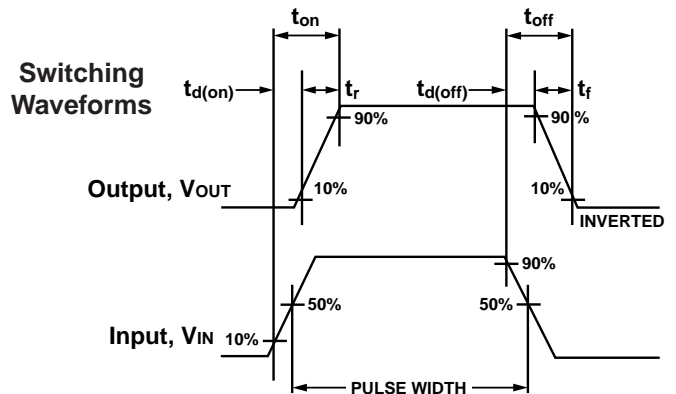
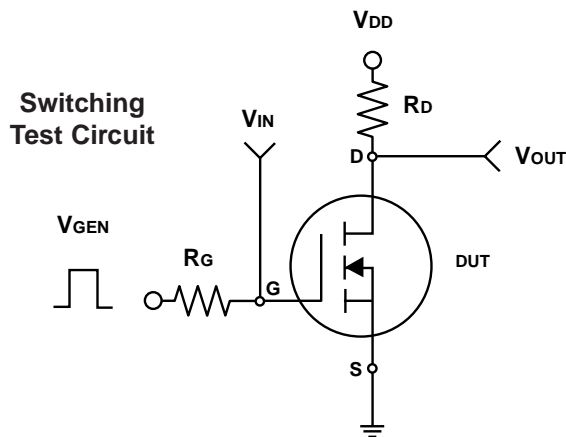

**N-Channel Enhancement-Mode MOSFET**

**Ratings and Characteristic Curves** ( $T_A = 25^\circ\text{C}$  unless otherwise noted)

**Fig. 1 – Output Characteristics**

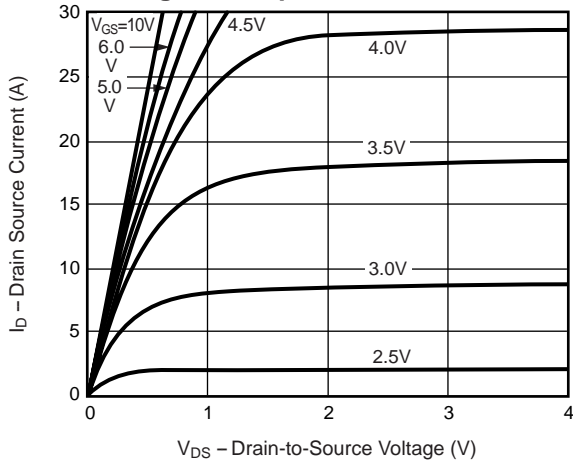

**Fig. 2 – Transfer Characteristics**

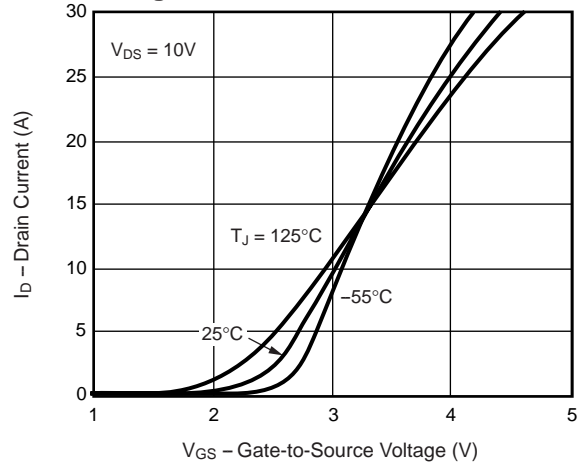

**Fig. 3 – Threshold Voltage vs. Temperature**

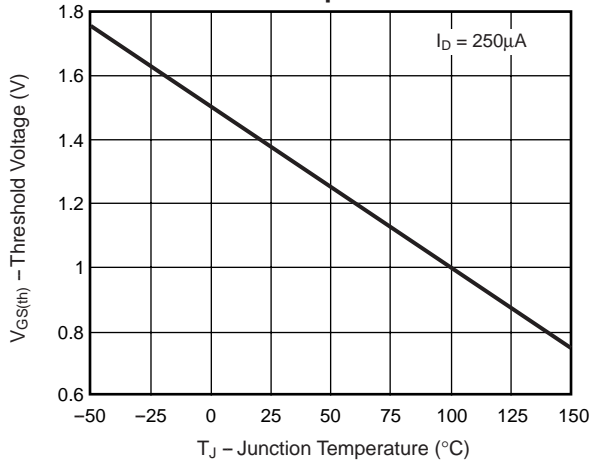

**Fig. 4 – On-Resistance vs. Drain Current**

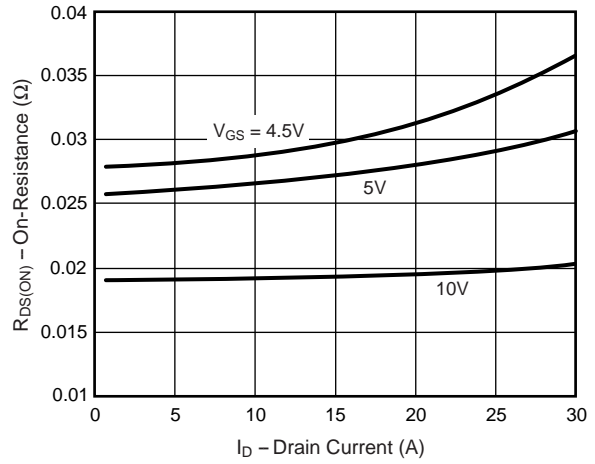

**Fig. 5 – On-Resistance vs. Junction Temperature**

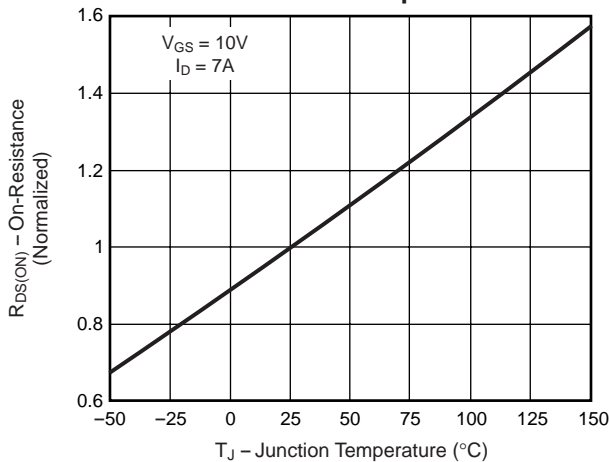

N-Channel Enhancement-Mode MOSFET

Ratings and Characteristic Curves (T<sub>A</sub> = 25°C unless otherwise noted)

Fig. 6 – On-Resistance vs. Gate-to-Source Voltage

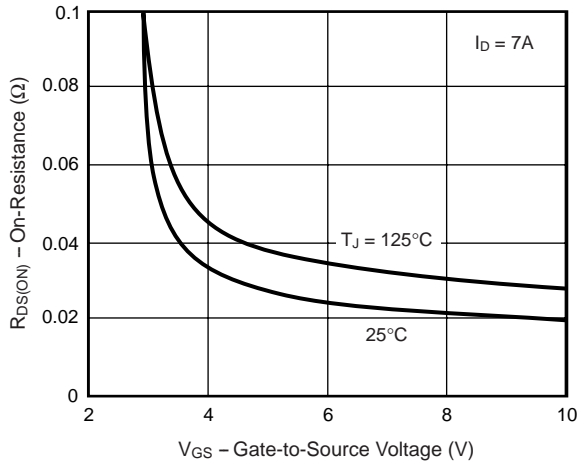

Fig. 7 – Gate Charge

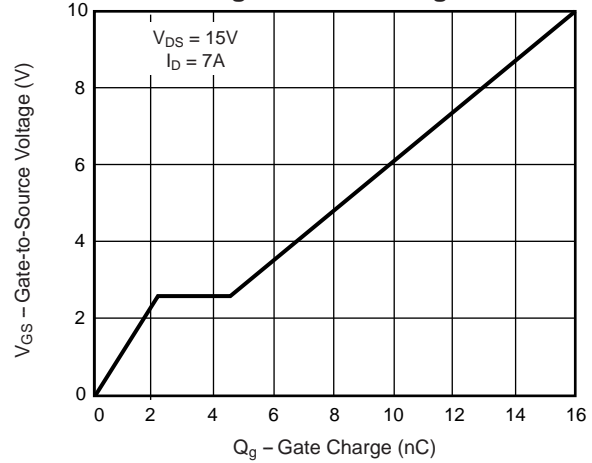

Fig. 8 – Capacitance

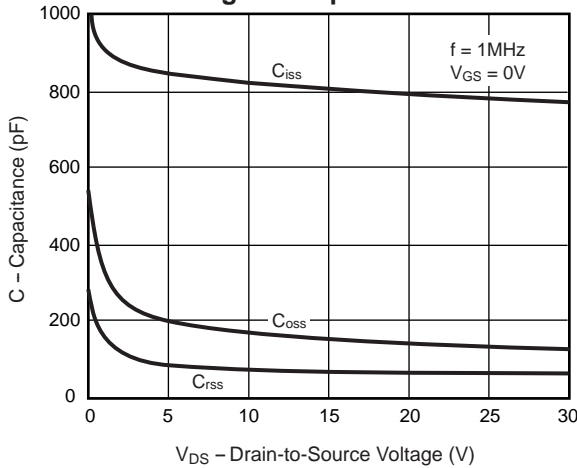
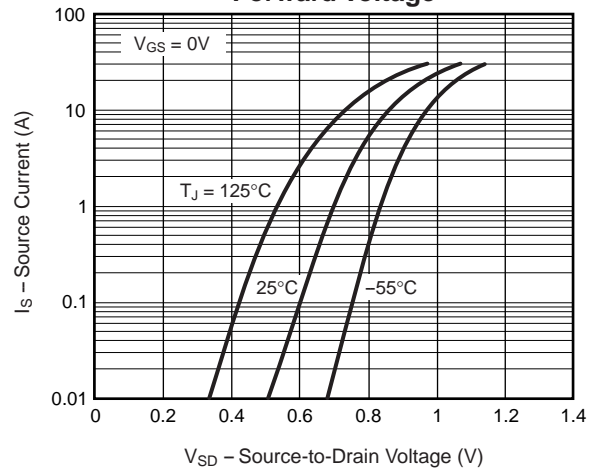

Fig. 9 – Source-Drain Diode Forward Voltage



N-Channel Enhancement-Mode MOSFET

Ratings and Characteristic Curves (T<sub>A</sub> = 25°C unless otherwise noted)

Fig. 10 – Breakdown Voltage vs. Junction Temperature

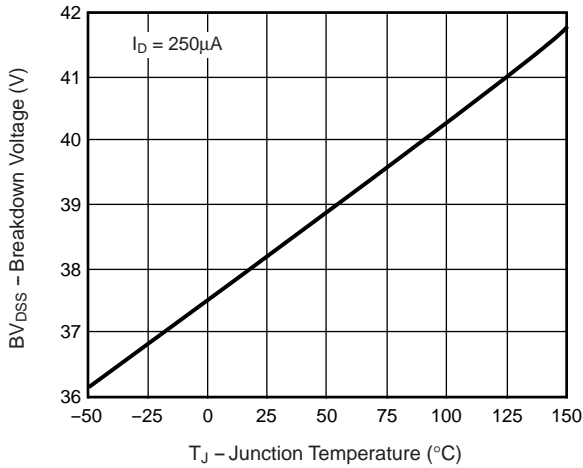

Fig. 11 – Transient Thermal Impedance

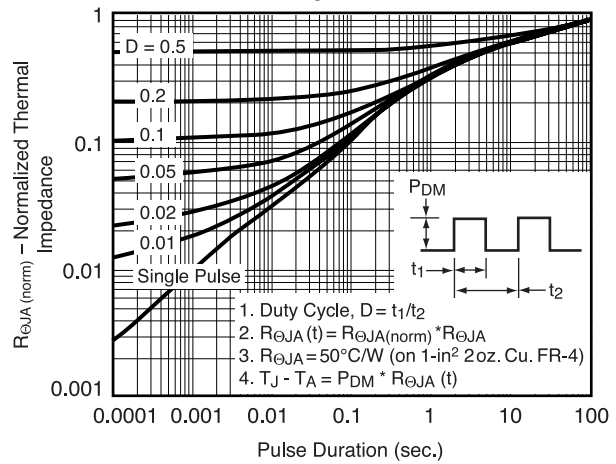

Fig. 12 – Power vs. Pulse Duration

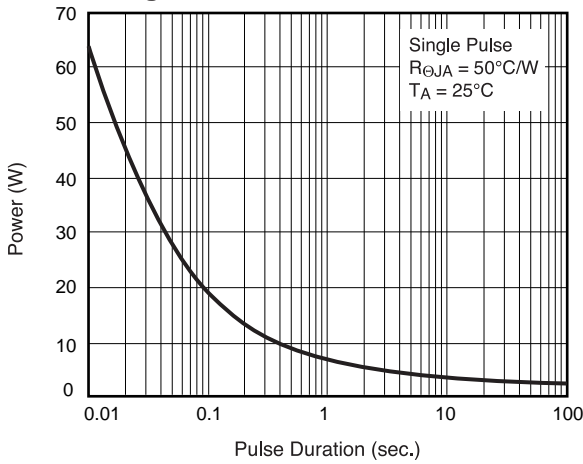

Fig. 13 – Maximum Safe Operating Area

