

0.6A, 200V, 1.500 Ohm, P-Channel Power MOSFET

This P-Channel enhancement mode silicon gate power field effect transistor is an advanced power MOSFET designed, tested, and guaranteed to withstand a specified level of energy in the breakdown avalanche mode of operation. All of these power MOSFETs are designed for applications such as switching regulators, switching convertors, motor drivers, relay drivers, and drivers for high power bipolar switching transistors requiring high speed and low gate drive power. These types can be operated directly from integrated circuits.

Formerly developmental type TA17502.

Ordering Information

PART NUMBER	PACKAGE	BRAND
IRFD9220	HEXDIP	IRFD9220

NOTE: When ordering, use the entire part number.

Features

- 0.6A, 200V
- $r_{DS(ON)} = 1.500\Omega$
- Single Pulse Avalanche Energy Rated
- SOA is Power Dissipation Limited
- Nanosecond Switching Speeds
- Linear Transfer Characteristics
- High Input Impedance

Symbol

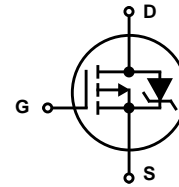

Packaging

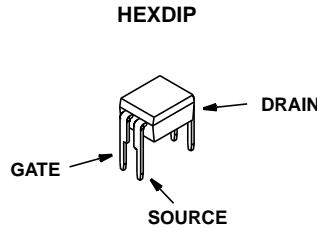

IRFD9220

Absolute Maximum Ratings $T_C = 25^\circ\text{C}$, Unless Otherwise Specified

	IRFD9220	UNITS
Drain to Source Voltage (Note 1)	V_{DS}	-200 V
Drain to Gate Voltage ($R_{GS} = 20k\Omega$) (Note 1)	V_{DGR}	-200 V
Continuous Drain Current	I_D	-0.6 A
Pulsed Drain Current (Note 3)	I_{DM}	-4.8 A
Gate to Source Voltage	V_{GS}	± 20 V
Maximum Power Dissipation	P_D	1.0 W
Linear Derating Factor		0.008 $W/^\circ\text{C}$
Single Pulse Avalanche Energy Rating (Note 4)	E_{AS}	290 mJ
Operating and Storage Temperature	T_J, T_{STG}	-55 to 150 $^\circ\text{C}$
Maximum Temperature for Soldering		
Leads at 0.063in (1.6mm) from Case for 10s	T_L	300 $^\circ\text{C}$
Package Body for 10s, See Techbrief 334	T_{pkg}	260 $^\circ\text{C}$

CAUTION: Stresses above those listed in "Absolute Maximum Ratings" may cause permanent damage to the device. This is a stress only rating and operation of the device at these or any other conditions above those indicated in the operational sections of this specification is not implied.

NOTE:

- $T_J = 25^\circ\text{C}$ to 125°C

Electrical Specifications $T_C = 25^\circ\text{C}$, Unless Otherwise Specified

PARAMETER	SYMBOL	TEST CONDITIONS	MIN	TYP	MAX	UNITS
Drain to Source Breakdown Voltage	BV_{DSS}	$I_D = -250\mu\text{A}, V_{GS} = 0\text{V}$, (Figure 9)	-200	-	-	V
Gate to Threshold Voltage	$V_{GS(TH)}$	$V_{GS} = V_{DS}, I_D = -250\mu\text{A}$	-2.0	-	-4.0	V
Zero Gate Voltage Drain Current	I_{DSS}	$V_{DS} = \text{Rated } BV_{DSS}, V_{GS} = 0\text{V}$	-	-	-25	μA
		$V_{DS} = 0.8 \times \text{Rated } BV_{DSS}, V_{GS} = 0\text{V}, T_C = 125^\circ\text{C}$	-	-	-250	μA
On-State Drain Current (Note 2)	$I_{D(ON)}$	$V_{DS} > I_{D(ON)} \times r_{DS(ON)MAX}, V_{GS} = -10\text{V}$	-0.6	-	-	A
Gate to Source Leakage Current	I_{GSS}	$V_{GS} = \pm 20\text{V}$	-	-	± 500	nA
On Resistance (Note 2)	$r_{DS(ON)}$	$I_D = -0.3\text{A}, V_{GS} = -10\text{V}$, (Figures 7, 8)	-	1.000	1.500	Ω
Forward Transconductance (Note 2)	g_{fs}	$V_{DS} < 50\text{V}, I_D = -0.3\text{A}$, (Figure 11)	0.6	1.0	-	S
Turn-On Delay Time	$t_{d(ON)}$	$V_{DD} = 0.5 \times \text{Rated } BV_{DSS}, I_D \approx 0.6\text{A}, R_G = 9.1\Omega$ $V_{GS} = -10\text{V}$, (Figures 16, 17) $R_L = 165\Omega$ for $V_{DD} = 100\text{V}$ MOSFET Switching Times are Essentially Independent of Operating Temperature.	-	15	40	ns
Rise Time	t_r		-	25	50	ns
Turn-Off Delay Time	$t_{d(OFF)}$		-	80	120	ns
Fall Time	t_f		-	50	75	ns
Total Gate Charge (Gate to Source + Gate to Drain)	$Q_g(\text{TOT})$	$V_{GS} = -10\text{V}, I_D = -0.6\text{A}, V_{DS} = 0.8 \times \text{Rated } BV_{DSS}$, $I_{G(\text{REF})} = 1.5\text{mA}$, (Figures 13, 18, 19) Gate Charge is Essentially Independent of Operating Temperature	-	16	22	nC
Gate to Source Charge	Q_{gs}		-	10	-	nC
Gate to Drain "Miller" Charge	Q_{gd}		-	4	-	nC
Input Capacitance	C_{ISS}	$V_{DS} = -25\text{V}, V_{GS} = 0\text{V}, f = 1\text{MHz}$, (Figure 10)	-	350	-	pF
Output Capacitance	C_{OSS}		-	100	-	pF
Reverse Transfer Capacitance	C_{RSS}		-	30	-	pF
Internal Drain Inductance	L_D	Measured From the Drain Lead, 2.0mm (0.08in) From Header to Center of Die	-	4.0	-	nH
Internal Source Inductance	L_S	Measured From the Source Lead, 0.2mm (0.08in) From Header to Source Bonding Pad	-	6.0	-	nH
		Modified MOSFET Symbol Showing the Internal Devices Inductances				
Thermal Resistance Junction to Ambient	$R_{\theta JA}$	Typical Socket Mount	-	-	120	$^\circ\text{C/W}$

Source to Drain Diode Specifications

PARAMETER	SYMBOL	TEST CONDITIONS	MIN	TYP	MAX	UNITS
Continuous Source to Drain Current	I_{SD}	Modified MOSFET Symbol Showing the Integral Reverse P-N Junction Diode	-	-	-0.6	A
Pulse Source to Drain Current (Note 3)	I_{SDM}		-	-	-4.8	A
Source to Drain Diode Voltage (Note 2)	V_{SD}	$T_C = 25^\circ\text{C}$, $I_{SD} = -0.6\text{A}$, $V_{GS} = 0\text{V}$ (Figure 12)	-	-	-1.5	V
Reverse Recovery Time	t_{rr}	$T_J = 150^\circ\text{C}$, $I_{SD} = -0.6\text{A}$, $dI_{SD}/dt = 100\text{A}/\mu\text{s}$	-	150	-	ns
Reverse Recovery Charge	Q_{RR}	$T_J = 150^\circ\text{C}$, $I_{SD} = -0.6\text{A}$, $dI_{SD}/dt = 100\text{A}/\mu\text{s}$	-	0.5	-	μC

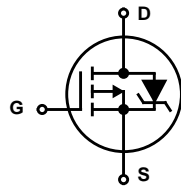

NOTES:

2. Pulse test: pulse width $\leq 300\mu\text{s}$, duty cycle $\leq 2\%$.
3. Repetitive rating: pulse width limited by maximum junction temperature.
4. $V_{DD} = 25\text{V}$, starting $T_J = 25^\circ\text{C}$, $L = 1210\text{mH}$, $R_G = 25\Omega$, Peak $I_{AS} = 0.6\text{A}$ (Figures 14, 15).

Typical Performance Curves Unless Otherwise Specified

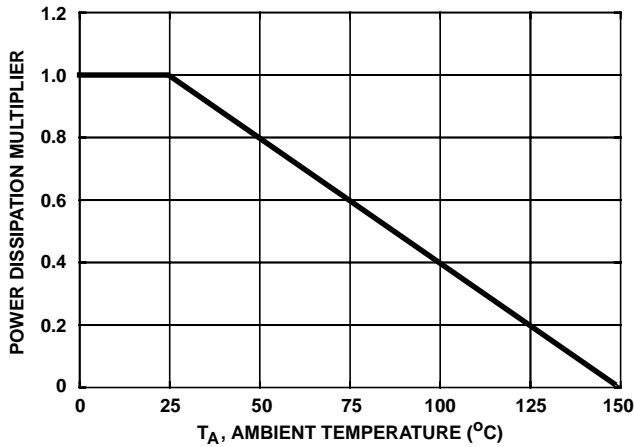

FIGURE 1. NORMALIZED POWER DISSIPATION vs AMBIENT TEMPERATURE

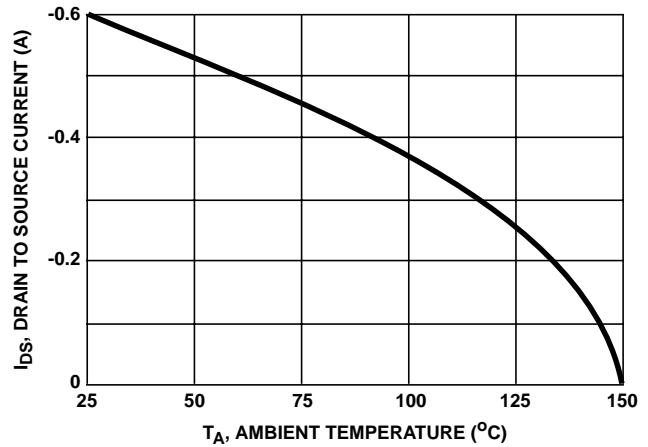

FIGURE 2. MAXIMUM CONTINUOUS DRAIN CURRENT vs AMBIENT TEMPERATURE

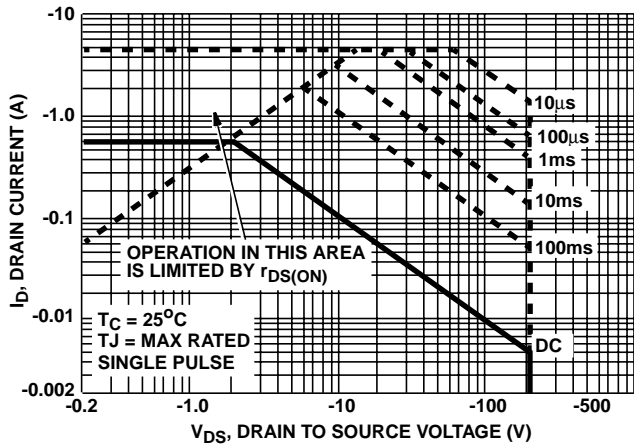

FIGURE 3. FORWARD BIAS SAFE OPERATING AREA

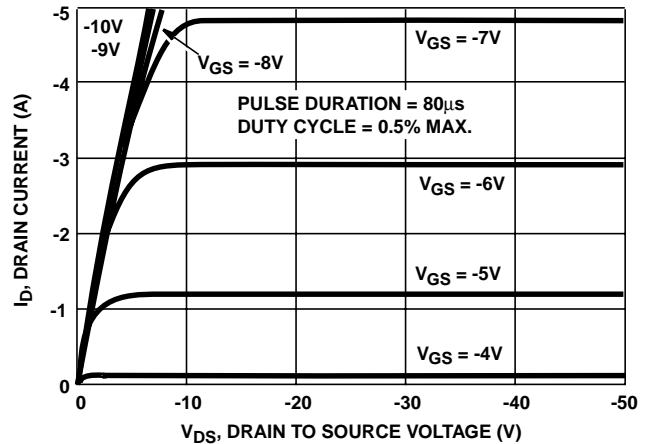

FIGURE 4. OUTPUT CHARACTERISTICS

Typical Performance Curves Unless Otherwise Specified (Continued)

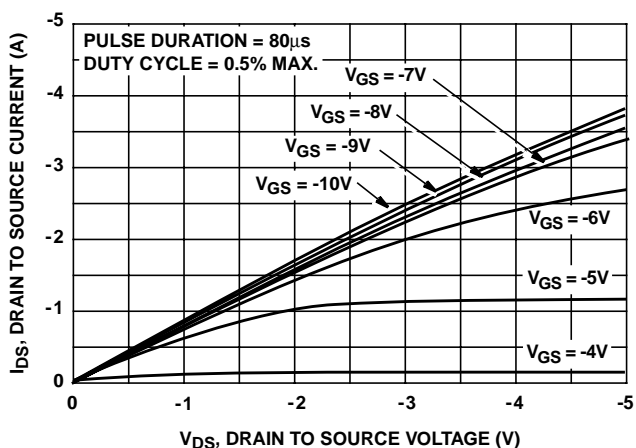

FIGURE 5. SATURATION CHARACTERISTICS

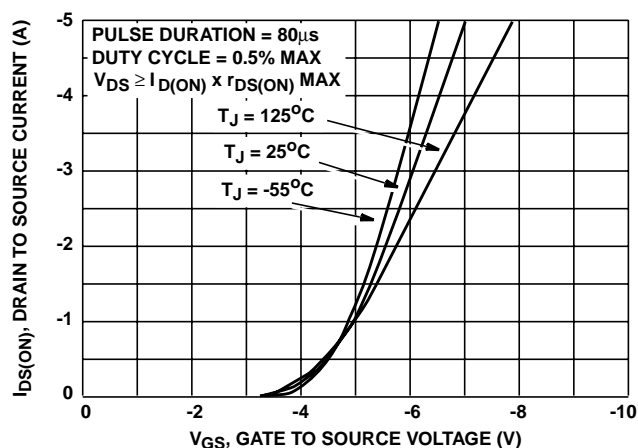
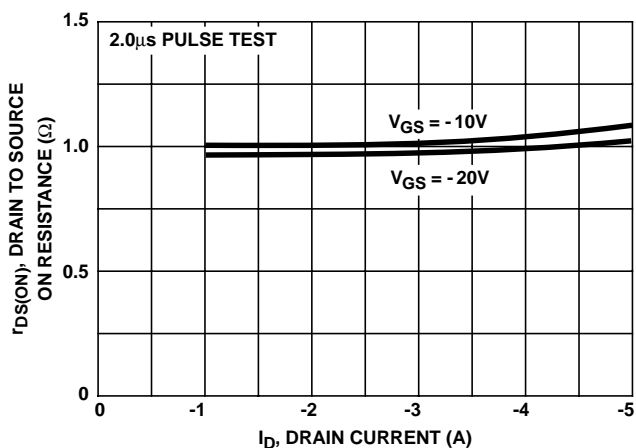

FIGURE 6. TRANSFER CHARACTERISTICS



NOTE: Effect of 2.0µs pulse is minimal.

FIGURE 7. DRAIN TO SOURCE ON RESISTANCE vs GATE VOLTAGE AND DRAIN CURRENT

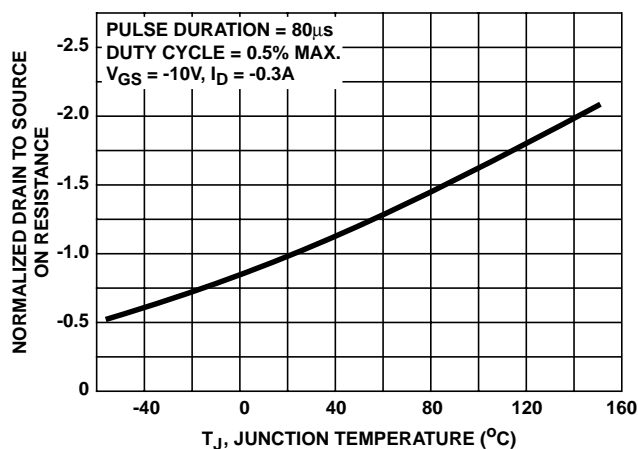

FIGURE 8. NORMALIZED DRAIN TO SOURCE ON RESISTANCE vs JUNCTION TEMPERATURE

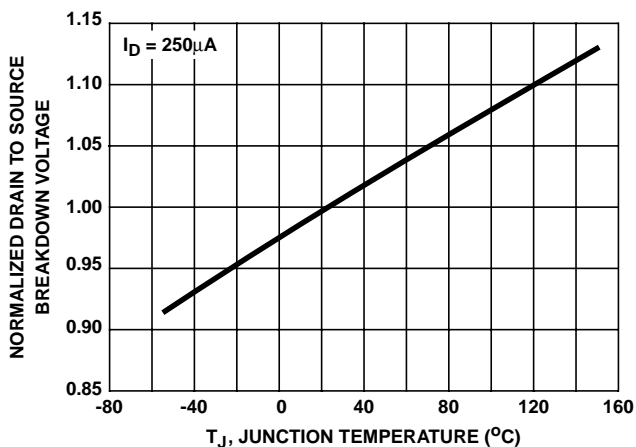

FIGURE 9. NORMALIZED DRAIN TO SOURCE BREAKDOWN VOLTAGE vs JUNCTION TEMPERATURE

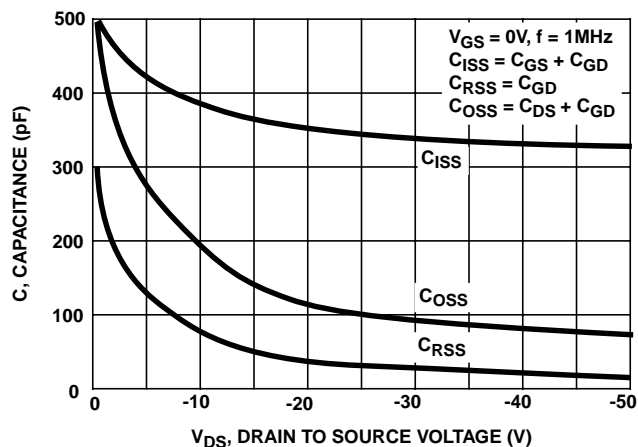

FIGURE 10. CAPACITANCE vs DRAIN TO SOURCE VOLTAGE

Typical Performance Curves Unless Otherwise Specified (Continued)

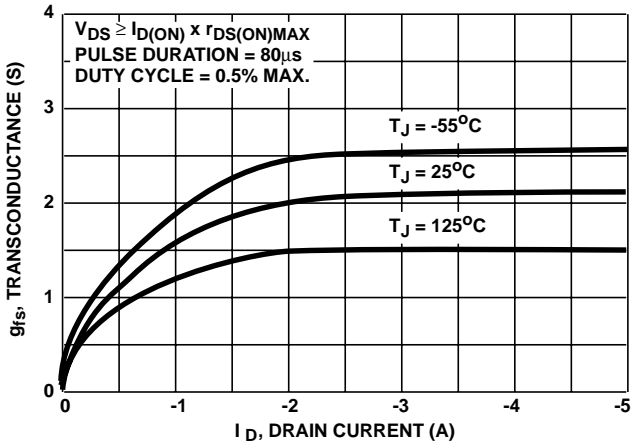

FIGURE 11. TRANSCONDUCTANCE vs DRAIN CURRENT

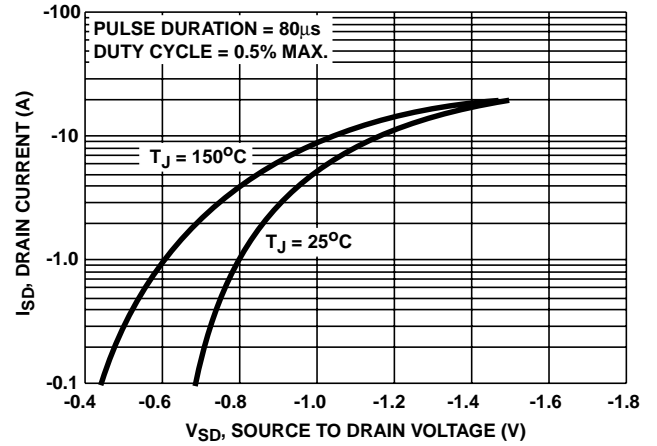

FIGURE 12. SOURCE TO DRAIN DIODE VOLTAGE

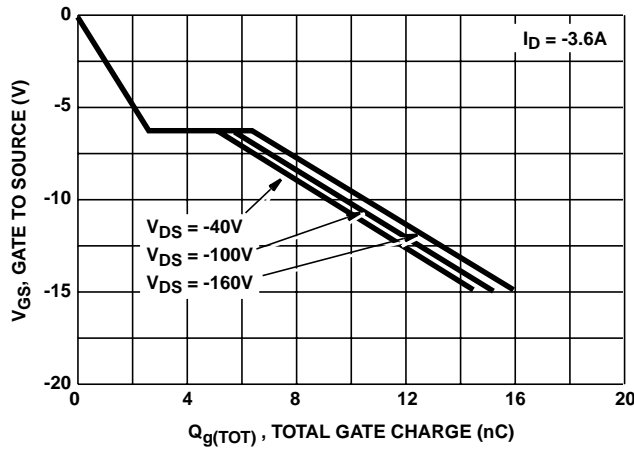

FIGURE 13. GATE TO SOURCE VOLTAGE vs GATE CHARGE

Test Circuits and Waveforms

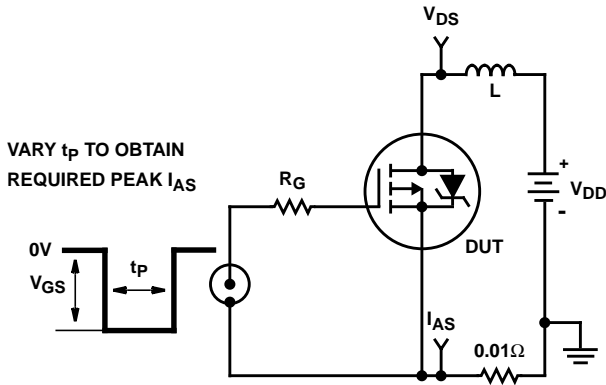

FIGURE 14. UNCLAMPED ENERGY TEST CIRCUIT

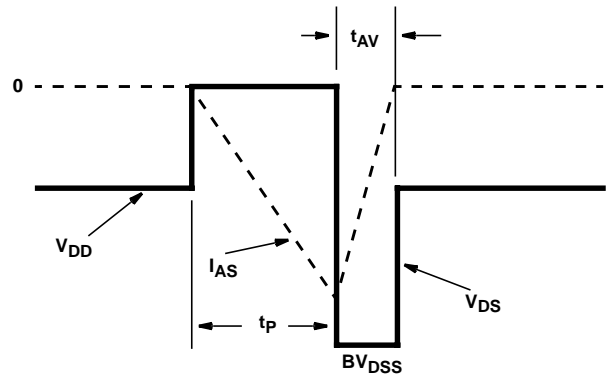

FIGURE 15. UNCLAMPED ENERGY WAVEFORMS

Test Circuits and Waveforms (Continued)

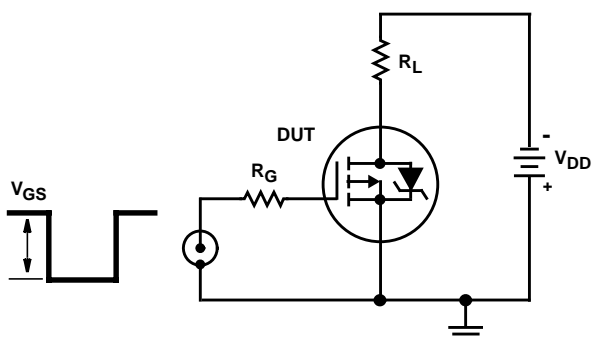

FIGURE 16. SWITCHING TIME TEST CIRCUIT

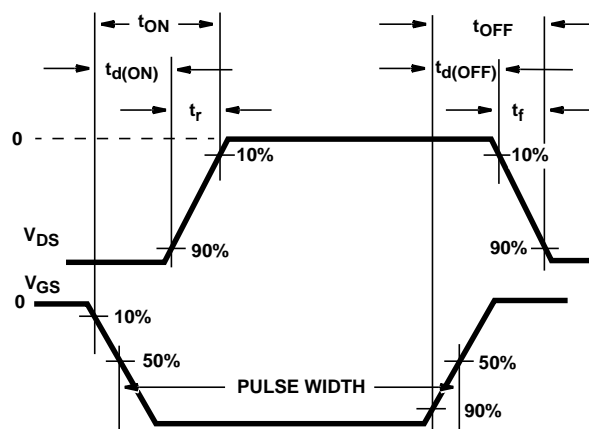

FIGURE 17. RESISTIVE SWITCHING WAVEFORMS

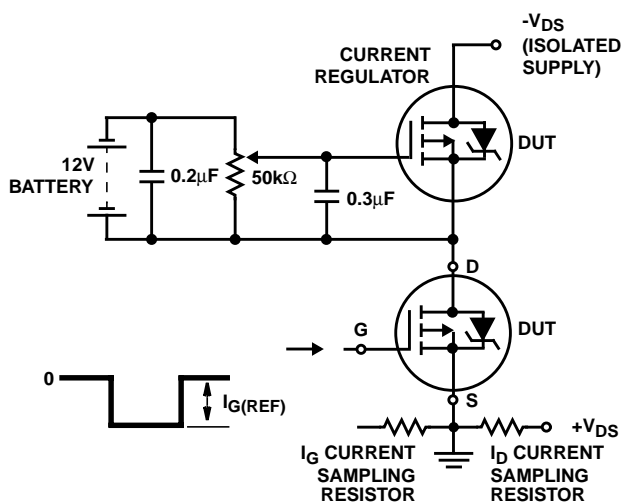

FIGURE 18. GATE CHARGE TEST CIRCUIT

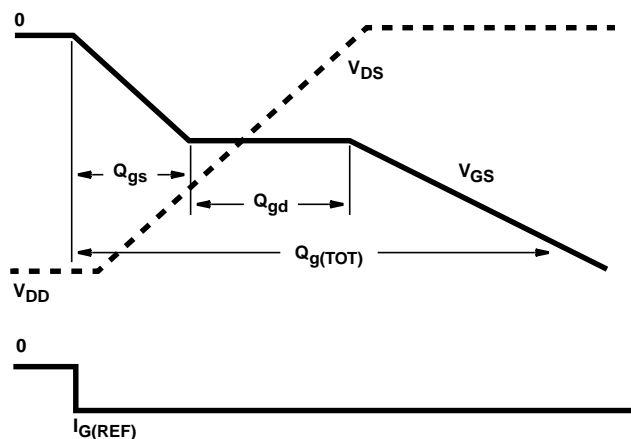

FIGURE 19. GATE CHARGE WAVEFORMS

All Intersil semiconductor products are manufactured, assembled and tested under **ISO9000** quality systems certification.

Intersil semiconductor products are sold by description only. Intersil Corporation reserves the right to make changes in circuit design and/or specifications at any time without notice. Accordingly, the reader is cautioned to verify that data sheets are current before placing orders. Information furnished by Intersil is believed to be accurate and reliable. However, no responsibility is assumed by Intersil or its subsidiaries for its use; nor for any infringements of patents or other rights of third parties which may result from its use. No license is granted by implication or otherwise under any patent or patent rights of Intersil or its subsidiaries.

For information regarding Intersil Corporation and its products, see web site <http://www.intersil.com>

Sales Office Headquarters

NORTH AMERICA

Intersil Corporation
P. O. Box 883, Mail Stop 53-204
Melbourne, FL 32902
TEL: (407) 724-7000
FAX: (407) 724-7240

EUROPE

Intersil SA
Mercure Center
100, Rue de la Fusee
1130 Brussels, Belgium
TEL: (32) 2.724.2111
FAX: (32) 2.724.22.05

ASIA

Intersil (Taiwan) Ltd.
7F-6, No. 101 Fu Hsing North Road
Taipei, Taiwan
Republic of China
TEL: (886) 2 2716 9310
FAX: (886) 2 2715 3029