

SYNCHRONOUS BURST SRAM

128K x 18 SRAM

**+3.3V POWER SUPPLY ,
REGISTERED INPUTS, BURST COUNTER**

FEATURES

- Fast access times: 8, 8.5, 10, and 11ns
- Fast clock speed: 100, 90, and 67 MHz
- Provide high performance 2-1-1-1 access rate
- Fast OE# access times: 3.5, 4.0, 4.5, and 5.0ns
- 3.3V -5% and +10% power supply
- Separate isolated output buffer supply compatible with 3.3V and 2.5V I/O (VCCQ): 2.375V to 3.6V
- 5V tolerant inputs except I/O's
- Clamp diodes to VSS/VSSQ at all inputs and outputs
- Common data inputs and data outputs
- BYTE WRITE ENABLE and GLOBAL WRITE control
- Three chip enables for depth expansion and address pipeline
- Address, data and control registers
- Internally self-timed WRITE CYCLE
- Burst control pins (interleaved or linear burst sequence)
- Automatic power-down for portable applications
- High density, high speed packages

OPTIONS

- Timing
 - 8ns access/10ns cycle
 - 8.5ns access/11ns cycle
 - 10ns access/15ns cycle
 - 11ns access/15ns cycle
- Packages
 - 100-pin TQFP

MARKING

-8
-9
-10
-11

T

GENERAL DESCRIPTION

The Galvantech Synchronous Burst SRAM family employs high-speed, low power CMOS designs using advanced triple-layer polysilicon, double-layer metal technology. Each memory cell consists of four transistors and two high valued resistors.

The GVT71128B18 SRAM integrates 131,072x18 SRAM cells with advanced synchronous peripheral circuitry and a 2-bit counter for internal burst operation. All synchronous inputs are gated by registers controlled by a positive-edge-triggered clock input (CLK). The synchronous inputs include all addresses, all data inputs, address-pipelining chip enable (CE#), depth-expansion chip enables (CE2# and CE2), burst control inputs (ADSC#, ADSP#, and ADV#), write enables (WEL#, WEH#, and BWE#), and global write (GW#).

Asynchronous inputs include the output enable (OE#), burst mode control (MODE), and sleep mode control (ZZ). The data outputs (DQ), enabled by OE#, are also asynchronous.

Addresses and chip enables are registered with either address status processor (ADSP#) or address status controller (ADSC#) input pins. Subsequent burst addresses can be internally generated as controlled by the burst advance pin (ADV#).

Address, data inputs, and write controls are registered on-chip to initiate self-timed WRITE cycle. WRITE cycles can be one or two bytes wide as controlled by the write control inputs. Individual byte enables allow individual bytes to be written. WEL# controls DQ1-DQ8 and DQP1. WEH# controls DQ9-DQ16 and DQP2. WEL# and WEH# can be active only with BWE# being LOW. GW# being LOW causes all bytes to be written.

The GVT71128B18 operates from a +3.3V power supply. All inputs and outputs are TTL-compatible. The device is ideally suited for 486, Pentium™, 680x0, and PowerPC™ systems and for systems that are benefited from a wide synchronous data bus.

FUNCTIONAL BLOCK DIAGRAM

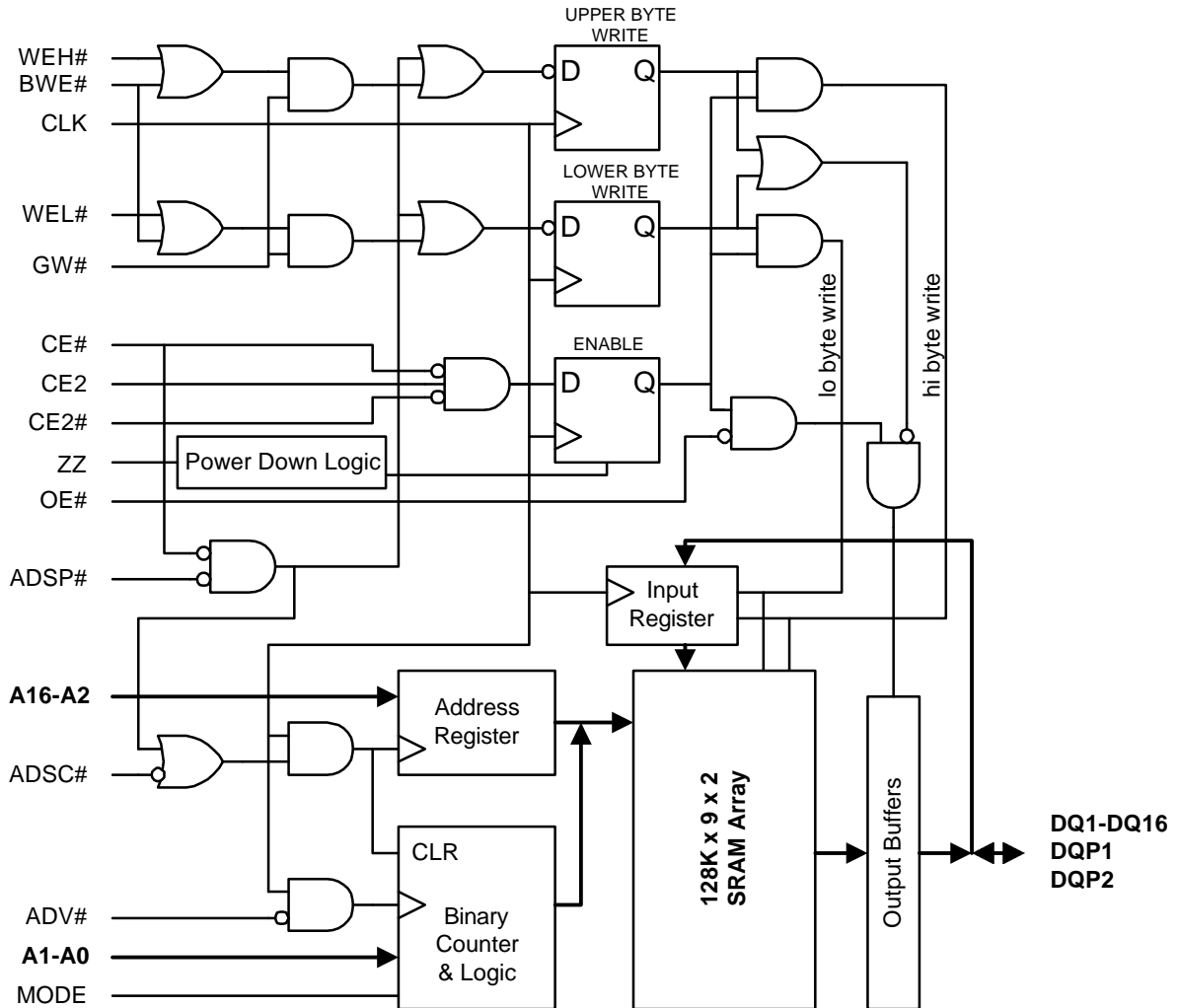

NOTE: The Functional Block Diagram illustrates simplified device operation. See Truth Table, pin descriptions and timing diagrams for detailed information.

PIN ASSIGNMENT (Top View)

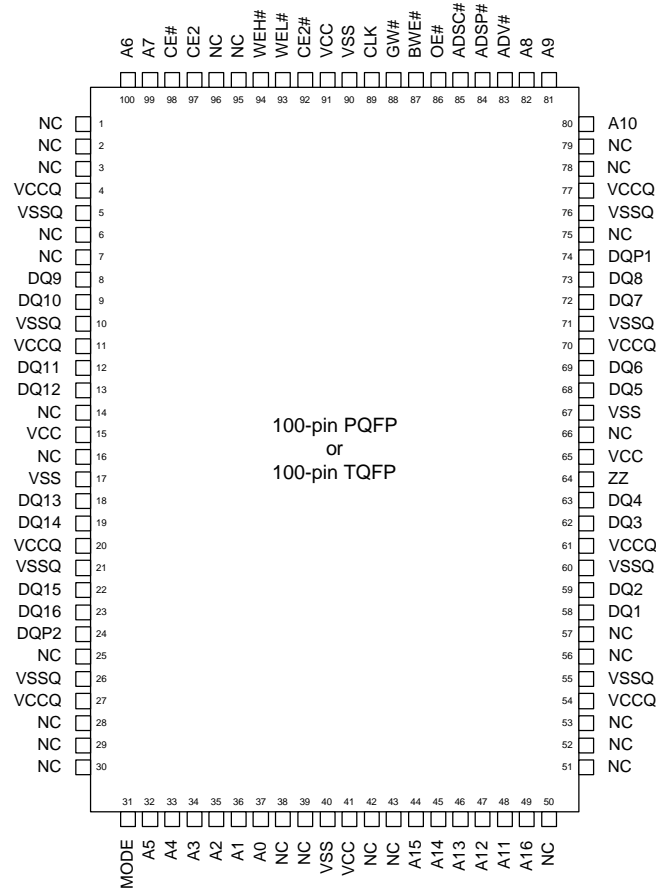

PIN DESCRIPTIONS

QFP PINS	SYMBOL	TYPE	DESCRIPTION
37, 36, 35, 34, 33, 32, 100, 99, 82, 81, 80, 48, 47, 46, 45, 44, 49	A0-A16	Input-Synchronous	Addresses: These inputs are registered and must meet the setup and hold times around the rising edge of CLK. The burst counter generates internal addresses associated with A0 and A1, during burst cycle and wait cycle.
93, 94	WEL#, WEH#	Input-Synchronous	Byte Write Enables: A byte write enable is LOW for a WRITE cycle and HIGH for a READ cycle. WEL# controls DQ1-DQ8 and DQP1. WEH# controls DQ9-DQ16 and DQP2. Data I/O are high impedance if either of these inputs are LOW, conditioned by BWE# being LOW.
87	BWE#	Input-Synchronous	Write Enable: This active LOW input gates byte write operations and must meet the setup and hold times around the rising edge of CLK.
88	GW#	Input-Synchronous	Global Write: This active LOW input allows a full 18-bit WRITE to occur independent of the BWE# and WEn# lines and must meet the setup and hold times around the rising edge of CLK.
89	CLK	Input-Synchronous	Clock: This signal registers the addresses, data, chip enables, write control and burst control inputs on its rising edge. All synchronous inputs must meet setup and hold times around the clock's rising edge.
98	CE#	Input-Synchronous	Chip Enable: This active LOW input is used to enable the device and to gate ADSP#.
92	CE2#	Input-Synchronous	Chip Enable: This active LOW input is used to enable the device.

PIN DESCRIPTIONS (continued)

QFP PINS	SYMBOL	TYPE	DESCRIPTION
97	CE2	input-Synchronous	Chip enable: This active HIGH input is used to enable the device.
86	OE#	Input	Output Enable: This active LOW asynchronous input enables the data output drivers.
83	ADV#	Input-Synchronous	Address Advance: This active LOW input is used to control the internal burst counter. A HIGH on this pin generates wait cycle (no address advance).
84	ADSP#	Input-Synchronous	Address Status Processor: This active LOW input, along with CE# being LOW, causes a new external address to be registered and a READ cycle is initiated using the new address.
85	ADSC#	Input-Synchronous	Address Status Controller: This active LOW input causes device to be de-selected or selected along with new external address to be registered. A READ or WRITE cycle is initiated depending upon write control inputs.
31	MODE	Input-Static	Mode: This input selects the burst sequence. A LOW on this pin selects LINEAR BURST. A NC or HIGH on this pin selects INTERLEAVED BURST.
64	ZZ	Input-Asynchronous	Snooze: This active HIGH input puts the device in low power consumption standby mode. For normal operation, this input has to be either LOW or NC (No Connect).
58, 59, 62, 63, 68, 69, 72, 73, 8, 9, 12, 13, 18, 19, 22, 23	DQ1-DQ16	Input/Output	Data Inputs/Outputs: Low Byte is DQ1-DQ8. High Byte is DQ9-DQ16. Input data must meet setup and hold times around the rising edge of CLK.
74, 24	DQP1, DQP2	Input/Output	Parity Inputs/Outputs: DQP1 is parity bit for DQ1-DQ8 and DQP2 is parity bit for DQ9-DQ16.
15, 41, 65, 91	VCC	Supply	Power Supply: +3.3V -5% and +10%
17, 40, 67, 90	VSS	Ground	Ground: GND.
4, 11, 20, 27, 54, 61, 70, 77	VCCQ	I/O Supply	Output Buffer Supply: +2.375 to 3.6V
5, 10, 21, 26, 55, 60, 71, 76	VSSQ	I/O Ground	Output Buffer Ground: GND
1-3, 6, 7, 14, 16, 25, 28-30, 38, 39, 42, 43, 51-50, 53, 56, 57, 66, 75, 78, 79, 80, 95, 96	NC	-	No Connect: These signals are not internally connected.

BURST ADDRESS TABLE (MODE = NC/VCC)

First Address (external)	Second Address (internal)	Third Address (internal)	Fourth Address (internal)
A...A00	A...A01	A...A10	A...A11
A...A01	A...A00	A...A11	A...A10
A...A10	A...A11	A...A00	A...A01
A...A11	A...A10	A...A01	A...A00

BURST ADDRESS TABLE (MODE = GND)

First Address (external)	Second Address (internal)	Third Address (internal)	Fourth Address (internal)
A...A00	A...A01	A...A10	A...A11
A...A01	A...A10	A...A11	A...A00
A...A10	A...A11	A...A00	A...A01
A...A11	A...A00	A...A01	A...A10

TRUTH TABLE

OPERATION	ADDRESS USED	CE#	CE2#	CE2	ADSP#	ADSC#	ADV#	WRITE#	OE#	CLK	DQ
Deselected Cycle, Power Down	None	H	X	X	X	L	X	X	X	L-H	High-Z
Deselected Cycle, Power Down	None	L	X	L	L	X	X	X	X	L-H	High-Z
Deselected Cycle, Power Down	None	L	H	X	L	X	X	X	X	L-H	High-Z
Deselected Cycle, Power Down	None	L	X	L	H	L	X	X	X	L-H	High-Z
Deselected Cycle, Power Down	None	L	H	X	H	L	X	X	X	L-H	High-Z
READ Cycle, Begin Burst	External	L	L	H	L	X	X	X	L	L-H	Q
READ Cycle, Begin Burst	External	L	L	H	L	X	X	X	H	L-H	High-Z
WRITE Cycle, Begin Burst	External	L	L	H	H	L	X	L	X	L-H	D
READ Cycle, Begin Burst	External	L	L	H	H	L	X	H	L	L-H	Q
READ Cycle, Begin Burst	External	L	L	H	H	L	X	H	H	L-H	High-Z
READ Cycle, Continue Burst	Next	X	X	X	H	H	L	H	L	L-H	Q
READ Cycle, Continue Burst	Next	X	X	X	H	H	L	H	H	L-H	High-Z
READ Cycle, Continue Burst	Next	H	X	X	X	H	L	H	L	L-H	Q
READ Cycle, Continue Burst	Next	H	X	X	X	H	L	H	H	L-H	High-Z
WRITE Cycle, Continue Burst	Next	X	X	X	H	H	L	L	X	L-H	D
WRITE Cycle, Continue Burst	Next	H	X	X	X	H	L	L	X	L-H	D
READ Cycle, Suspend Burst	Current	X	X	X	H	H	H	H	L	L-H	Q
READ Cycle, Suspend Burst	Current	X	X	X	H	H	H	H	H	L-H	High-Z
READ Cycle, Suspend Burst	Current	H	X	X	X	H	H	H	L	L-H	Q
READ Cycle, Suspend Burst	Current	H	X	X	X	H	H	H	H	L-H	High-Z
WRITE Cycle, Suspend Burst	Current	X	X	X	H	H	H	L	X	L-H	D
WRITE Cycle, Suspend Burst	Current	H	X	X	X	H	H	L	X	L-H	D

- Note:
1. X means "don't care." H means logic HIGH. L means logic LOW. WRITE# = L means [BWE# + WEL#*WEH#]*GW# equals LOW. WRITE# = H means [BWE# + WEL#*WEH#]*GW# equals HIGH.
 2. WEL# enables write to DQ1-DQ8 and DQP1. WEH# enables write to DQ9-DQ16 and DQP2.
 3. All inputs except OE# must meet setup and hold times around the rising edge (LOW to HIGH) of CLK.
 4. Suspending burst generates wait cycle.
 5. For a write operation following a read operation, OE# must be HIGH before the input data required setup time plus High-Z time for OE# and staying HIGH throughout the input data hold time.
 6. This device contains circuitry that will ensure the outputs will be in High-Z during power-up.
 7. ADSP# LOW along with chip being selected always initiates an READ cycle at the L-H edge of CLK. A WRITE cycle can be performed by setting WRITE# LOW for the CLK L-H edge of the subsequent wait cycle. Refer to WRITE timing diagram for clarification.

PARTIAL TRUTH TABLE FOR READ/WRITE

FUNCTION	GW#	BWE#	WEH#	WEL#
READ	H	H	X	X
READ	H	L	H	H
WRITE one byte	H	L	L	H
WRITE all bytes	H	L	L	L
WRITE all bytes	L	X	X	X

ABSOLUTE MAXIMUM RATINGS*

Voltage on VCC Supply Relative to VSS...-0.5V to +4.6V
V_{IN}-0.5V to $V_{CC}+0.5V$
Storage Temperature (plastic)-55°C to +125°
Junction Temperature+125°
Power Dissipation1.4W
Short Circuit Output Current100mA

*Stresses greater than those listed under “Absolute Maximum Ratings” may cause permanent damage to the device. This is a stress rating only and functional operation of the device at these or any other conditions above those indicated in the operational sections of this specification is not implied. Exposure to absolute maximum rating conditions for extended periods may affect reliability.

DC ELECTRICAL CHARACTERISTICS AND RECOMMENDED OPERATING CONDITIONS

(0°C ≤ T_a ≤ 70°C; VCC = 3.3V -5% and +10% unless otherwise noted)

DESCRIPTION	CONDITIONS	SYMBOL	MIN	MAX	UNITS	NOTES
Input High (Logic 1) voltage		V_{IH}	2.0	$V_{CC}+0.3$	V	1,2
Input Low (Logic 0) Voltage		V_{IL}	-0.3	0.8	V	1, 2
Input Leakage Current	$0V \leq V_{IN} \leq V_{CC}$	I_{L1}	-2	2	uA	14
Output Leakage Current	Output(s) disabled, $0V \leq V_{OUT} \leq V_{CC}$	I_{LO}	-2	2	uA	
Output High Voltage	$I_{OH} = -4.0mA$	V_{OH}	2.4		V	1, 11
Output Low Voltage	$I_{OL} = 8.0mA$	V_{OL}		0.8	V	1, 11
Supply Voltage		VCC	3.135	3.6	V	1
I/O Supply		VCCQ	2.375	3.6		

DESCRIPTION	CONDITIONS	SYM	TYP	-8	-9	-10	-11	UNITS	NOTES
Power Supply Current: Operating	Device selected; all inputs ≤ V_{IL} or ≥ V_{IH} ; cycle time ≥ 4KC MIN; VCC = MAX; outputs open	I _{CC}	200	300	280	260	260	mA	3, 12, 13
CMOS Standby	Device deselected; VCC = MAX; all inputs ≤ $V_{SS} + 0.2$ or ≥ $V_{CC} - 0.2$; all inputs static; CLK frequency = 0	I _{SB2}	1	2	2	2	2	mA	12,13
TTL Standby	Device deselected; all inputs ≤ V_{IL} or ≥ V_{IH} ; all inputs static; VCC = MAX; CLK frequency = 0	I _{SB3}	4	10	10	10	10	mA	12,13
Clock Running	Device deselected; all inputs ≤ V_{IL} or ≥ V_{IH} ; VCC = MAX; CLK cycle time ≥ 4KC MIN	I _{SB4}	60	95	90	80	80	mA	12,13

AC ELECTRICAL CHARACTERISTICS(Note 5) ($0^{\circ}\text{C} \leq T_A \leq 70^{\circ}\text{C}$; $V_{CC} = 3.3\text{V} -5\%$ and $+10\%$)

DESCRIPTION	SYM	- 8		- 9		- 10		- 11		UNITS	NOTES
		MIN	MAX	MIN	MAX	MIN	MAX	MIN	MAX		
Clock											
Clock cycle time	t_{KC}	10		11		15		15		ns	
Clock HIGH time	t_{KH}	4		4.5		5		5		ns	
Clock LOW time	t_{KL}	4		4.5		5		5		ns	
Output Times											
Clock to output valid	t_{KQ}		8		8.5		10		11	ns	
Clock to output invalid	t_{KQX}	2		2		2		2		ns	
Clock to output in Low-Z	t_{KQLZ}	0		0		0		0		ns	4, 6, 7
Clock to output in High-Z	t_{KQHZ}	2	3.5	2	3.5	2	3.5	2	3.5	ns	4, 6, 7
OE to output valid	t_{OEQ}		3.5		4.0		4.5		5.0	ns	9
OE to output in Low-Z	t_{OELZ}	0		0		0		0		ns	4, 6, 7
OE to output in High-Z	t_{OEHZ}		3.5		3.5		3.5		3.5	ns	4, 6, 7
Setup Times											
Address, Controls and Data In	t_S	2.0		2.0		2.0		2.0		ns	10
Hold Times											
Address, Controls and Data In	t_H	0.5		0.5		0.5		0.5		ns	10

CAPACITANCE

DESCRIPTION	CONDITIONS	SYMBOL	TYP	MAX	UNITS	NOTES
Input Capacitance	$T_A = 25^{\circ}\text{C}$; $f = 1\text{ MHz}$ $V_{CC} = 3.3\text{V}$	C_I	4	5	pF	4
Input/Output Capacitance (DQ)		C_O	7	8	pF	4

THERMAL CONSIDERATION

DESCRIPTION	CONDITIONS	SYMBOL	TQFP TYP	UNITS	NOTES
Thermal Resistance - Junction to Ambient	Still air, soldered on 4.25 x 1.125 inch 4-layer PCB	θ_{JA}	25	$^{\circ}\text{C}/\text{W}$	
Thermal Resistance - Junction to Case		θ_{JC}	9	$^{\circ}\text{C}/\text{W}$	

TYPICAL OUTPUT BUFFER CHARACTERISTICS

OUTPUT HIGH VOLTAGE	PULL-UP CURRENT		OUTPUT LOW VOLTAGE	PULL-DOWN CURRENT	
	IOH(mA) Min	IOH(mA) Max		IOL(mA) Min	IOL(mA) Max
VOH (V)			VOL (V)		
-0.5	-38	-105	-0.5	0	0
0	-38	-105	0	0	0
0.8	-38	-105	0.4	10	20
1.25	-26	-83	0.8	20	40
1.5	-20	-70	1.25	31	63
2.3	0	-30	1.6	40	80
2.7	0	-10	2.8	40	80
2.9	0	0	3.2	40	80
3.4	0	0	3.4	40	80

AC TEST CONDITIONS

Input pulse levels	0V to 3.0V
Input rise and fall times	1.5ns
Input timing reference levels	1.5V
Output reference levels	1.5V
Output load	See Figures 1

OUTPUT LOADS

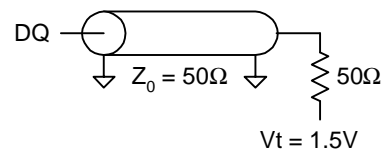

Fig. 1 OUTPUT LOAD EQUIVALENT

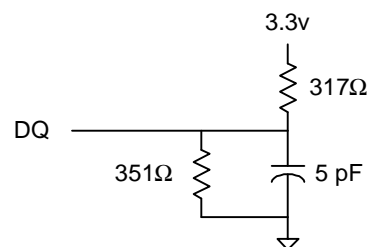

Fig. 2 OUTPUT LOAD EQUIVALENT

NOTES

- All voltages referenced to VSS (GND).
- Overshoot: $V_{IH} \leq +6.0V$ for $t \leq {}^tKC / 2$.
Undershoot: $V_{IL} \leq -2.0V$ for $t \leq {}^tKC / 2$
- I_{cc} is given with no output current. I_{cc} increases with greater output loading and faster cycle times.
- This parameter is sampled.
- Test conditions as specified with the output loading as shown in Fig. 1 unless otherwise noted.
- Output loading is specified with $CL=5pF$ as in Fig. 2.
- At any given temperature and voltage condition, tKQHZ is less than tKQLZ and tOEHZ is less than tOELZ .
- A READ cycle is defined by byte write enables all HIGH or ADSP# LOW along with chip enables being active for the required setup and hold times. A WRITE cycle is defined by at one byte or all byte WRITE per READ/WRITE TRUTH TABLE.
- OE# is a "don't care" when a byte write enable is sampled LOW.
- This is a synchronous device. All synchronous inputs must meet specified setup and hold time, except for "don't care" as defined in the truth table.
- AC I/O curves are available upon request.
- "Device Deselected" means the device is in POWER -DOWN mode as defined in the truth table. "Device Selected" means the device is active.
- Typical values are measured at 3.3V, 25°C and 20ns cycle time.
- MODE pin has an internal pull-up and ZZ pin has an internal pull-down. These two pins exhibit an input leakage current of $\pm 30 \mu A$.

- Capacitance derating applies to capacitance different from the load capacitance shown in Fig. 1.

READ TIMING

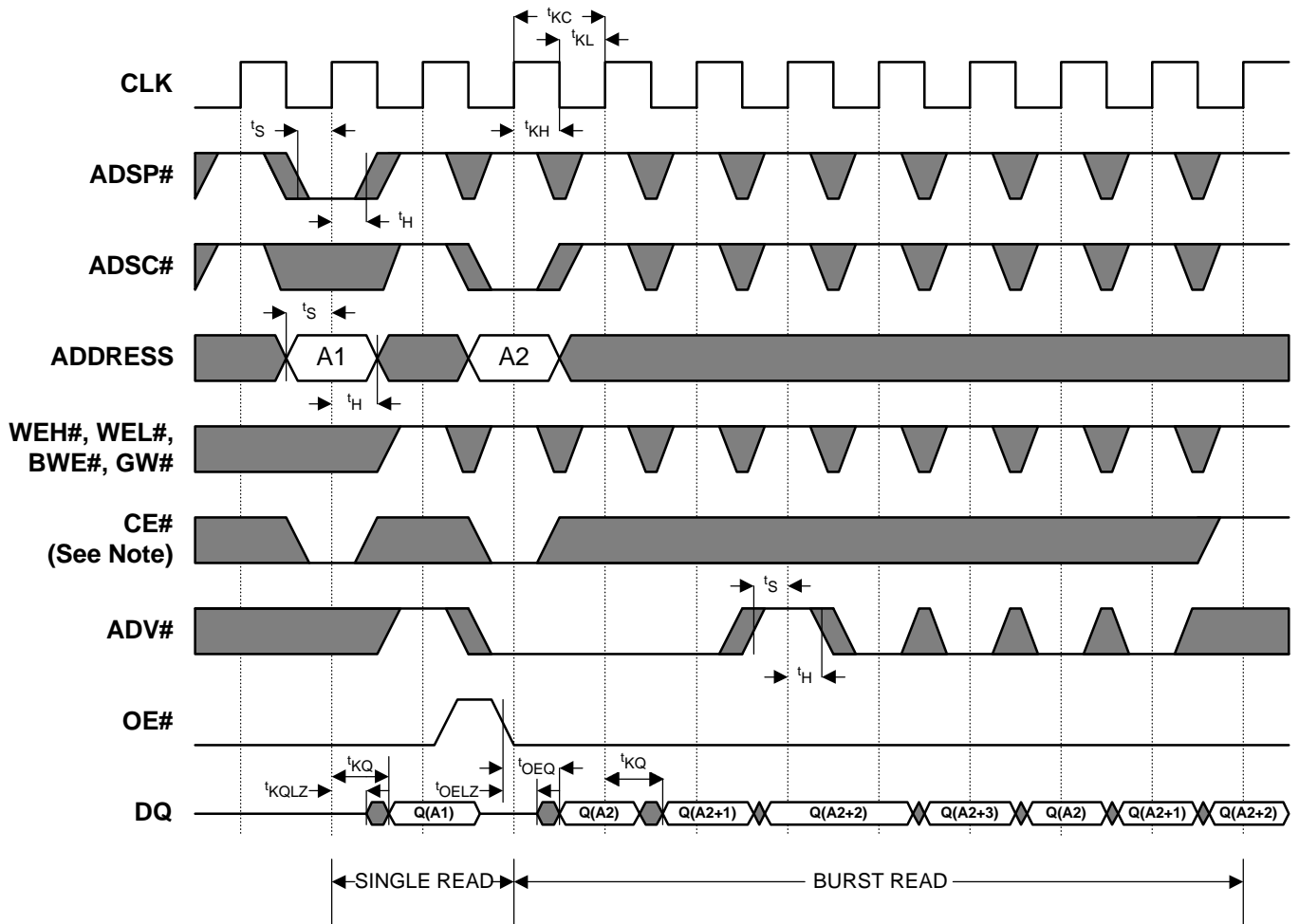

Note: CE# active in this timing diagram means that all chip enables CE#, CE2, and CE2# are active.

WRITE TIMING

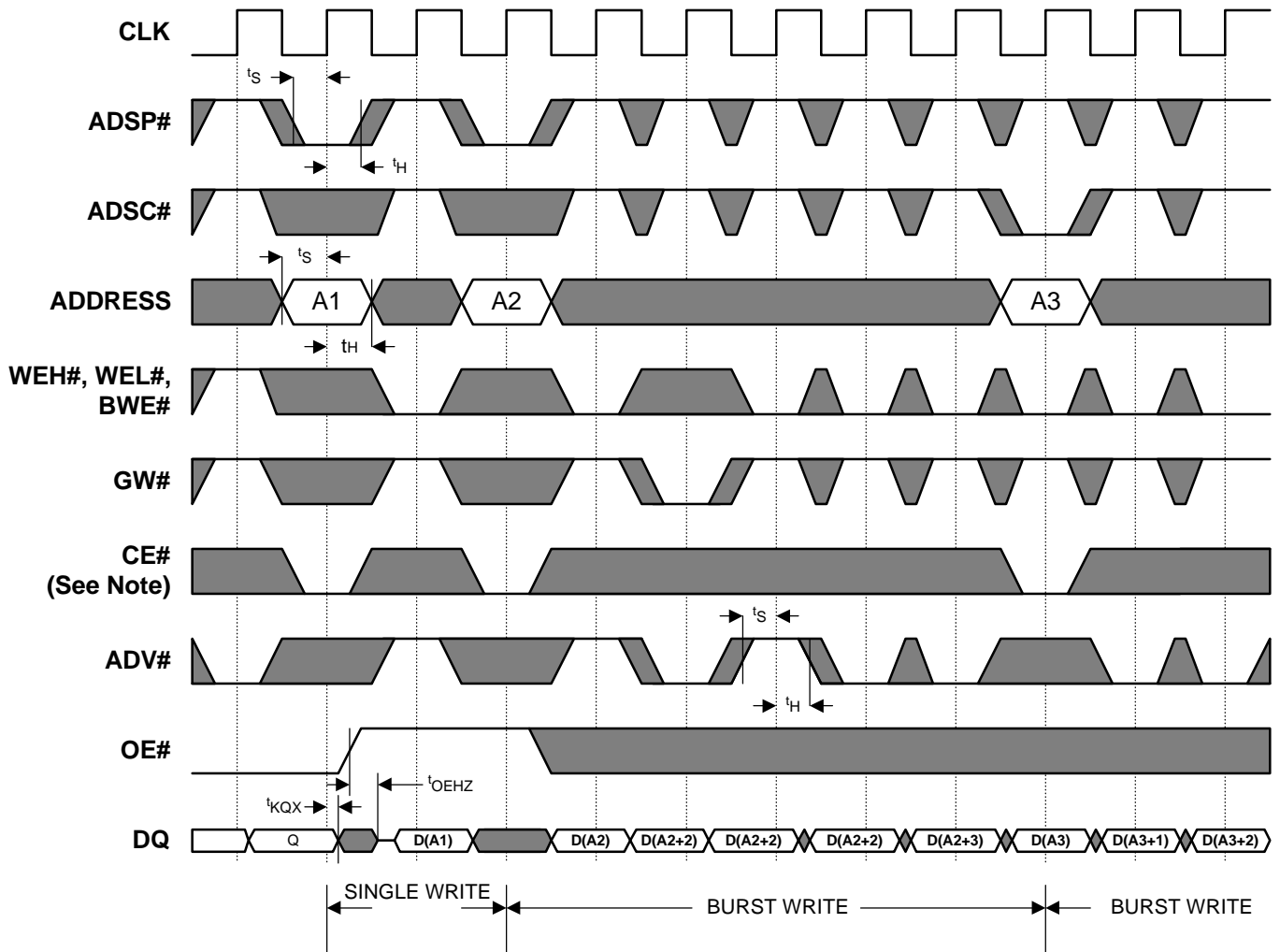

Note: CE# active in this timing diagram means that all chip enables CE#, CE2, and CE2# are active.

READ/WRITE TIMING

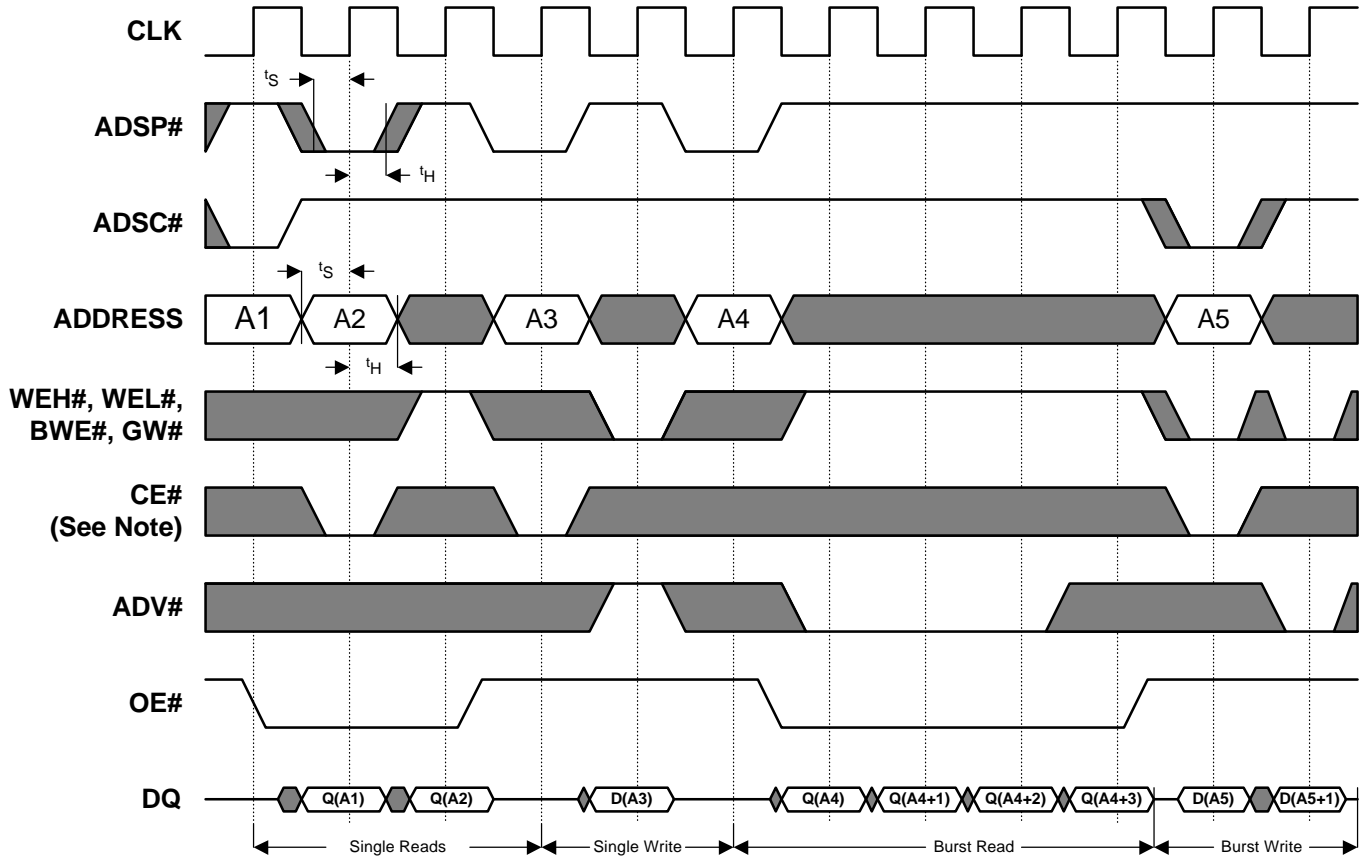

Note: CE# active in this timing diagram means that all chip enables CE#, CE2, and CE2# are active.

100 Pin TQFP Package Dimensions

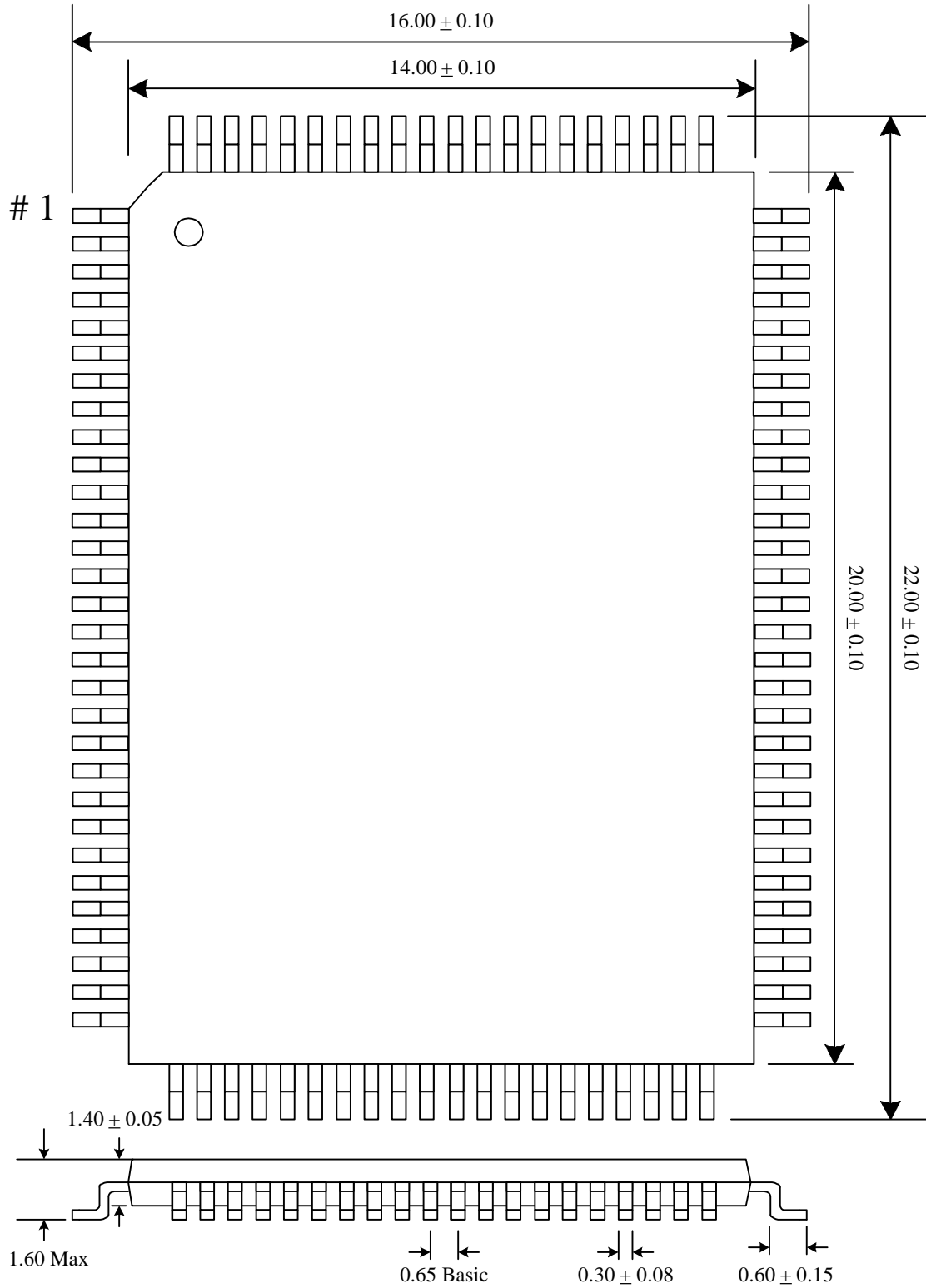

Note: All dimensions in Millimeters

Ordering Information

GVT 71128B18 X - XX

Galvantech Prefix

Part Number

Speed (8 = 8.0ns access/10ns cycle
9 = 8.5ns access/11ns cycle
10 = 10ns access/15ns cycle
11 = 11ns access/15ns cycle)

Package (T = 100 PIN PQFP)