

## 74VCXH162244 Low Voltage 16-Bit Buffer/Line Driver with Bushold and 26Ω Series Resistor in Outputs

### General Description

The VCXH162244 contains sixteen non-inverting buffers with 3-STATE outputs to be employed as a memory and address driver, clock driver, or bus oriented transmitter/receiver. The device is nibble (4-bit) controlled. Each nibble has separate 3-STATE control inputs which can be shorted together for full 16-bit operation. .

The VCXH162244 data inputs include active bushold circuitry, eliminating the need for external pull-up resistors to hold unused or floating data inputs at a valid logic level

The 74VCXH162244 is also designed with 26Ω series resistors in the outputs. This design reduces line noise in applications such as memory address drivers, clock drivers, and bus transceivers/transmitters.

The 74VCXH162244 is designed for low voltage (1.65V to 3.6V)  $V_{CC}$  applications with output capability up to 3.6V.

The 74VCXH162244 is fabricated with an advanced CMOS technology to achieve high speed operation while maintaining low CMOS power dissipation.

### Features

- 1.65V–3.6V  $V_{CC}$  supply operation
- 3.6V tolerant control inputs and outputs
- Bushold on data inputs eliminates the need for external pull-up/pull-down resistors
- 26Ω series resistors in outputs
- $t_{PD}$ 
  - 3.3 ns max for 3.0V to 3.6V  $V_{CC}$
  - 3.8 ns max for 2.3V to 2.7V  $V_{CC}$
  - 7.6 ns max for 1.65V to 1.95V  $V_{CC}$
- Static Drive ( $I_{OH}/I_{OL}$ )
  - ±12 mA @ 3.0V  $V_{CC}$
  - ±8 mA @ 2.3V  $V_{CC}$
  - ±3 mA @ 1.65V  $V_{CC}$
- Uses patented noise/EMI reduction circuitry
- Latch-up performance exceeds 300 mA
- ESD performance:
  - Human body model > 2000V
  - Machine model > 200V

### Ordering Code:

| Order Number             | Package Number | Package Description   |
|--------------------------|----------------|---|
| 74VCXH162244MTD          | MTD48          | 48-Lead Thin Shrink Small Outline Package (TSSOP), JEDEC MO-153, 6.1mm Wide [TUBES]         |
| 74VCXH162244MTX (Note 1) | MTD48          | 48-Lead Thin Shrink Small Outline Package (TSSOP), JEDEC MO-153, 6.1mm Wide [TAPE and REEL] |

**Note 1:** Use this Order Number to receive devices in Tape and Reel.

### Logic Symbol

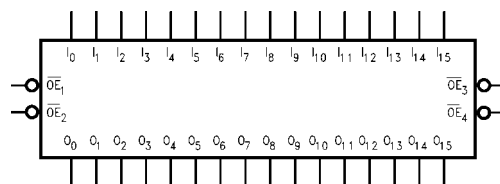

### Pin Descriptions

| Pin Names         | Description                      |
|-------------------|----------------------------------|
| $\overline{OE}_n$ | Output Enable Input (Active LOW) |
| $I_0-I_{15}$      | Bushold Inputs                   |
| $O_0-O_{15}$      | Outputs                          |

### Connection Diagram

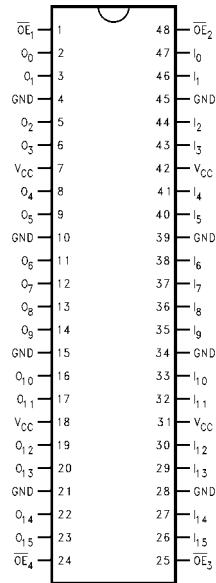

### Truth Tables

| Inputs            |           | Outputs   |
|-------------------|-----------|-----------|
| $\overline{OE}_1$ | $I_0-I_3$ | $O_0-O_3$ |
| L                 | L         | L         |
| L                 | H         | H         |
| H                 | X         | Z         |

| Inputs            |           | Outputs   |
|-------------------|-----------|-----------|
| $\overline{OE}_2$ | $I_4-I_7$ | $O_4-O_7$ |
| L                 | L         | L         |
| L                 | H         | H         |
| H                 | X         | Z         |

| Inputs            |              | Outputs      |
|-------------------|--------------|--------------|
| $\overline{OE}_3$ | $I_8-I_{11}$ | $O_8-O_{11}$ |
| L                 | L            | L            |
| L                 | H            | H            |
| H                 | X            | Z            |

| Inputs            |                 | Outputs         |
|-------------------|-----------------|-----------------|
| $\overline{OE}_4$ | $I_{12}-I_{15}$ | $O_{12}-O_{15}$ |
| L                 | L               | L               |
| L                 | H               | H               |
| H                 | X               | Z               |

H = HIGH Voltage Level  
 L = LOW Voltage Level  
 X = Immaterial (HIGH or LOW, inputs may not float)  
 Z = High Impedance

### Functional Description

The 74VCXH162244 contains sixteen non-inverting buffers with 3-STATE outputs. The device is nibble (4 bits) controlled with each nibble functioning identically, but independent of each other. The control pins may be shorted together to obtain full 16-bit operation. The 3-STATE outputs are controlled by an Output Enable ( $\overline{OE}_n$ ) input. When  $\overline{OE}_n$  is LOW, the outputs are in the 2-state mode. When  $\overline{OE}_n$  is HIGH, the standard outputs are in the high impedance mode but this does not interfere with entering new data into the inputs.

### Logic Diagram

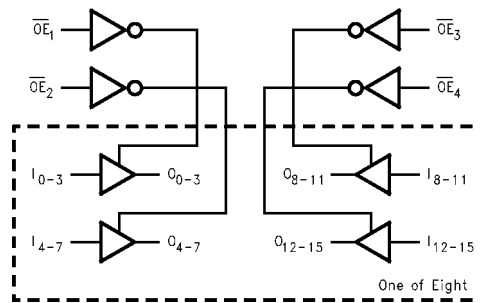

**Absolute Maximum Ratings** (Note 2)

|  |                          |
|--|--------------------------|
| Supply Voltage ( $V_{CC}$ )                                  | -0.5V to +4.6V           |
| DC Input Voltage ( $V_I$ )                                   |                          |
| $\overline{OE}_n$  | -0.5V to 4.6V            |
| $I_O - I_{15}$   | -0.5V to $V_{CC} + 0.5V$ |
| Output Voltage ( $V_O$ )                                     |                          |
| Outputs 3-STATE  | -0.5V to +4.6V           |
| Outputs Active (Note 3)                                      | -0.5V to $V_{CC} + 0.5V$ |
| DC Input Diode Current ( $I_{IK}$ )                          |                          |
| $V_I < 0V$   | -50 mA                   |
| DC Output Diode Current ( $I_{OK}$ )                         |                          |
| $V_O < 0V$   | -50 mA                   |
| $V_O > V_{CC}$   | +50 mA                   |
| DC Output Source/Sink Current ( $I_{OH}/I_{OL}$ )            | $\pm 50$ mA              |
| DC $V_{CC}$ or GND Current per Supply Pin ( $I_{CC}$ or GND) | $\pm 100$ mA             |
| Storage Temperature Range ( $T_{STG}$ )                      | -65°C to +150°C          |

**Recommended Operating Conditions** (Note 4)

|   |                   |
|---|-------------------|
| Power Supply                                    |                   |
| Operating                                       | 1.65V to 3.6V     |
| Data Retention Only                             | 1.2V to 3.6V      |
| Input Voltage                                   | -0.3V to $V_{CC}$ |
| Output Voltage ( $V_O$ )                        |                   |
| Output in Active States                         | 0V to $V_{CC}$    |
| Output in 3-STATE                               | 0.0V to 3.6V      |
| Output Current in $I_{OH}/I_{OL}$               |                   |
| $V_{CC} = 3.0V$ to 3.6V                         | $\pm 12$ mA       |
| $V_{CC} = 2.3V$ to 2.7V                         | $\pm 8$ mA        |
| $V_{CC} = 1.65V$ to 2.3V                        | $\pm 3$ mA        |
| Free Air Operating Temperature ( $T_A$ )        | -40°C to +85°C    |
| Minimum Input Edge Rate ( $\Delta t/\Delta V$ ) |                   |
| $V_{IN} = 0.8V$ to 2.0V, $V_{CC} = 3.0V$        | 10 ns/V           |

**Note 2:** The Absolute Maximum Ratings are those values beyond which the safety of the device cannot be guaranteed. The device should not be operated at these limits. The parametric values defined in the Electrical Characteristics tables are not guaranteed at the Absolute Maximum Ratings. The "Recommended Operating Conditions" table will define the conditions for actual device operation.

**Note 3:**  $I_O$  Absolute Maximum Rating must be observed.

**Note 4:** Floating or unused control inputs must be held HIGH or LOW.

**DC Electrical Characteristics (2.7V <  $V_{CC}$  ≤ 3.6V)**

| Symbol          | Parameter  |              | Conditions   | $V_{CC}$ (V) | Min            | Max       | Units   |
|-----------------|--|--------------|--|--------------|----------------|-----------|---------|
| $V_{IH}$        | HIGH Level Input Voltage                         |              |  | 2.7-3.6      | 2.0            |           | V       |
| $V_{IL}$        | LOW Level Input Voltage                          |              |  | 2.7-3.6      |                | 0.8       | V       |
| $V_{OH}$        | HIGH Level Output Voltage                        |              | $I_{OH} = -100 \mu A$                                | 2.7-3.6      | $V_{CC} - 0.2$ |           | V       |
|                 |  |              | $I_{OH} = -6$ mA                                     | 2.7          | 2.2            |           | V       |
|                 |  |              | $I_{OH} = -8$ mA                                     | 3.0          | 2.4            |           | V       |
|                 |  |              | $I_{OH} = -12$ mA                                    | 3.0          | 2.2            |           | V       |
| $V_{OL}$        | LOW Level Output Voltage                         |              | $I_{OL} = 100 \mu A$                                 | 2.7-3.6      |                | 0.2       | V       |
|                 |  |              | $I_{OL} = 6$ mA                                      | 2.7          |                | 0.4       | V       |
|                 |  |              | $I_{OL} = 8$ mA                                      | 3.0          |                | 0.55      | V       |
|                 |  |              | $I_{OL} = 12$ mA                                     | 3.0          |                | 0.8       | V       |
| $I_I$           | Input Leakage Current                            | Control Pins | $0 \leq V_I \leq 3.6V$                               | 2.7-3.6      |                | $\pm 5.0$ | $\mu A$ |
|                 |  | Data Pins    | $V_I = V_{CC}$ or GND                                | 2.7-3.6      |                | $\pm 5.0$ | $\mu A$ |
| $I_{I(HOLD)}$   | Bushold Input Minimum Drive Hold Current         |              | $V_{IN} = 0.8V$                                      | 3.0          | 75             |           | $\mu A$ |
|                 |  |              | $V_{IN} = 2.0V$                                      | 3.0          | -75            |           | $\mu A$ |
| $I_{I(OD)}$     | Bushold Input Over-Drive Current to Change State |              | (Note 5)   | 3.6          | 450            |           | $\mu A$ |
|                 |  |              | (Note 6)   | 3.6          | -450           |           | $\mu A$ |
| $I_{OZ}$        | 3-STATE Output Leakage                           |              | $0 \leq V_O \leq 3.6V$<br>$V_I = V_{IH}$ or $V_{IL}$ | 2.7-3.6      |                | $\pm 10$  | $\mu A$ |
| $I_{OFF}$       | Power-OFF Leakage Current                        |              | $0 \leq (V_O) \leq 3.6V$                             | 0            |                | 10        | $\mu A$ |
| $I_{CC}$        | Quiescent Supply Current                         |              | $V_I = V_{CC}$ or GND                                | 2.7-3.6      |                | 20        | $\mu A$ |
|                 |  |              | $V_{CC} \leq (V_O) \leq 3.6V$ (Note 7)               | 2.7-3.6      |                | $\pm 20$  | $\mu A$ |
| $\Delta I_{CC}$ | Increase in $I_{CC}$ per Input                   |              | $V_{IH} = V_{CC} - 0.6V$                             | 2.7-3.6      |                | 750       | $\mu A$ |

**Note 5:** An external driver must source at least the specified current to switch from LOW-to-HIGH.

**Note 6:** An external driver must sink at least the specified current to switch from HIGH-to-LOW.

**Note 7:** Outputs disabled or 3-STATE only.

### DC Electrical Characteristics ( $2.3V \leq V_{CC} \leq 2.7V$ )

| Symbol               | Parameter  | Conditions   | V <sub>CC</sub> (V) | Min                   | Max  | Units |
|----------------------|--|--|---------------------|-----------------------|------|-------|
| V <sub>IH</sub>      | HIGH Level Input Voltage                         |  | 2.3-2.7             | 1.6                   |      | V     |
| V <sub>IL</sub>      | LOW Level Input Voltage                          |  | 2.3-2.7             |                       | 0.7  | V     |
| V <sub>OH</sub>      | HIGH Level Output Voltage                        | I <sub>OH</sub> = -100 μA  | 2.3-2.7             | V <sub>CC</sub> - 0.2 |      | V     |
|                      |  | I <sub>OH</sub> = -4 mA  | 2.3                 | 2.0                   |      | V     |
|                      |  | I <sub>OH</sub> = -6 mA  | 2.3                 | 1.8                   |      | V     |
|                      |  | I <sub>OH</sub> = -8 mA  | 2.3                 | 1.7                   |      | V     |
| V <sub>OL</sub>      | LOW Level Output Voltage                         | I <sub>OL</sub> = 100 μA   | 2.3-2.7             |                       | 0.2  | V     |
|                      |  | I <sub>OL</sub> = 6 mA   | 2.3                 |                       | 0.4  | V     |
|                      |  | I <sub>OL</sub> = 8 mA   | 2.3                 |                       | 0.6  | V     |
| I <sub>I</sub>       | Input Leakage Current                            | Control Pins<br>0 ≤ V <sub>I</sub> ≤ 3.6V  | 2.3-2.7             |                       | ±5.0 | μA    |
|                      |  | Data Pins<br>V <sub>I</sub> = V <sub>CC</sub> or GND                             | 2.3-2.7             |                       | ±5.0 | μA    |
| I <sub>I(HOLD)</sub> | Bushold Input Minimum                            | V <sub>IN</sub> = 0.7V   | 2.3                 | 45                    |      | μA    |
|                      | Drive Hold Current                               | V <sub>IN</sub> = 1.6V   | 2.3                 | -45                   |      |       |
| I <sub>I(OD)</sub>   | Bushold Input Over-Drive Current to Change State | (Note 8)   | 2.7                 | 300                   |      | μA    |
|                      |  | (Note 9)   | 2.7                 | -300                  |      |       |
| I <sub>OZ</sub>      | 3-STATE Output Leakage                           | 0 ≤ V <sub>O</sub> ≤ 3.6V<br>V <sub>I</sub> = V <sub>IH</sub> or V <sub>IL</sub> | 2.3-2.7             |                       | ±10  | μA    |
| I <sub>OFF</sub>     | Power-OFF Leakage Current                        | 0 ≤ (V <sub>O</sub> ) ≤ 3.6V   | 0                   |                       | 10   | μA    |
| I <sub>CC</sub>      | Quiescent Supply Current                         | V <sub>I</sub> = V <sub>CC</sub> or GND  | 2.3-2.7             |                       | 20   | μA    |
|                      |  | V <sub>CC</sub> ≤ (V <sub>O</sub> ) ≤ 3.6V (Note 10)                             | 2.3-2.7             |                       | ±20  | μA    |

**Note 8:** An external driver must source at least the specified current to switch from LOW-to-HIGH.

**Note 9:** An external driver must sink at least the specified current to switch from HIGH-to-LOW.

**Note 10:** Outputs disabled or 3-STATE only.

### DC Electrical Characteristics ( $1.65V \leq V_{CC} < 2.3V$ )

| Symbol               | Parameter  | Conditions   | V <sub>CC</sub> (V) | Min                    | Max                    | Units |
|----------------------|--|--|---------------------|------------------------|------------------------|-------|
| V <sub>IH</sub>      | HIGH Level Input Voltage                         |  | 1.65-2.3            | 0.65 × V <sub>CC</sub> |                        | V     |
| V <sub>IL</sub>      | LOW Level Input Voltage                          |  | 1.65-2.3            |                        | 0.35 × V <sub>CC</sub> | V     |
| V <sub>OH</sub>      | HIGH Level Output Voltage                        | I <sub>OH</sub> = -100 μA  | 1.65-2.3            | V <sub>CC</sub> - 0.2  |                        | V     |
|                      |  | I <sub>OH</sub> = -3 mA  | 1.65                | 1.25                   |                        | V     |
| V <sub>OL</sub>      | LOW Level Output Voltage                         | I <sub>OL</sub> = 100 μA   | 1.65-2.3            |                        | 0.2                    | V     |
|                      |  | I <sub>OL</sub> = 3mA  | 1.65                |                        | 0.3                    | V     |
| I <sub>I</sub>       | Input Leakage Current                            | Control Pins<br>0 ≤ V <sub>I</sub> ≤ 3.6V  | 1.65-2.3            |                        | ±5.0                   | μA    |
|                      |  | Data Pins<br>V <sub>I</sub> = V <sub>CC</sub> or GND                             | 1.65-2.3            |                        | ±5.0                   | μA    |
| I <sub>I(HOLD)</sub> | Bushold Input Minimum                            | V <sub>IN</sub> = 0.57V  | 1.65                | 25                     |                        | μA    |
|                      | Drive Hold Current                               | V <sub>IN</sub> = 1.07V  | 1.65                | -25                    |                        |       |
| I <sub>I(OD)</sub>   | Bushold Input Over-Drive Current to Change State | (Note 11)  | 1.95                | 200                    |                        | μA    |
|                      |  | (Note 12)  | 1.95                | -200                   |                        |       |
| I <sub>OZ</sub>      | 3-STATE Output Leakage                           | 0 ≤ V <sub>O</sub> ≤ 3.6V<br>V <sub>I</sub> = V <sub>IH</sub> or V <sub>IL</sub> | 1.65-2.3            |                        | ±10                    | μA    |
| I <sub>OFF</sub>     | Power-OFF Leakage Current                        | 0 ≤ (V <sub>O</sub> ) ≤ 3.6V   | 0                   |                        | 10                     | μA    |
| I <sub>CC</sub>      | Quiescent Supply Current                         | V <sub>I</sub> = V <sub>CC</sub> or GND  | 1.65-2.3            |                        | 20                     | μA    |
|                      |  | V <sub>CC</sub> ≤ (V <sub>O</sub> ) ≤ 3.6V (Note 13)                             | 1.65-2.3            |                        | ±20                    | μA    |

**Note 11:** An external driver must source at least the specified current to switch from LOW-to-HIGH.

**Note 12:** An external driver must sink at least the specified current to switch from HIGH-to-LOW.

**Note 13:** Outputs disabled or 3-STATE only.

| AC Electrical Characteristics (Note 14) |                                    |   |     |                          |     |                           |      |       |
|---|------------------------------------|---|-----|--------------------------|-----|---------------------------|------|-------|
| Symbol                                  | Parameter                          | $T_A = -40^\circ\text{C to } +85^\circ\text{C}, C_L = 30 \text{ pF}, R_L = 500\Omega$ |     |                          |     |                           |      | Units |
|   |                                    | $V_{CC} = 3.3V \pm 0.3V$  |     | $V_{CC} = 2.5V \pm 0.2V$ |     | $V_{CC} = 1.8V \pm 0.15V$ |      |       |
|   |                                    | Min   | Max | Min                      | Max | Min                       | Max  |       |
| $t_{PHL}, t_{PLH}$                      | Prop Delay                         | 0.8   | 3.3 | 1.0                      | 3.8 | 1.5                       | 7.6  | ns    |
| $t_{PZL}, t_{PZH}$                      | Output Enable Time                 | 0.8   | 3.8 | 1.0                      | 5.1 | 1.5                       | 9.8  | ns    |
| $t_{PLZ}, t_{PHZ}$                      | Output Disable Time                | 0.8   | 3.6 | 1.0                      | 4.0 | 1.5                       | 7.2  | ns    |
| $t_{OSHL}, t_{OSLH}$                    | Output to Output Skew<br>(Note 15) |   | 0.5 |                          | 0.5 |                           | 0.75 | ns    |

**Note 14:** For  $C_L = 50\text{pF}$ , add approximately 300 ps to the AC maximum specification.

**Note 15:** Skew is defined as the absolute value of the difference between the actual propagation delay for any two separate outputs of the same device. The specification applies to any outputs switching in the same direction, either HIGH-to-LOW ( $t_{OSHL}$ ) or LOW-to-HIGH ( $t_{OSLH}$ ).

| Dynamic Switching Characteristics |                                      |   |                 |                           |       |
|-----------------------------------|--------------------------------------|---|-----------------|---------------------------|-------|
| Symbol                            | Parameter                            | Conditions  | $V_{CC}$<br>(V) | $T_A = +25^\circ\text{C}$ | Units |
|                                   |                                      |   |                 | Typical                   |       |
| $V_{OLP}$                         | Quiet Output Dynamic Peak $V_{OL}$   | $C_L = 30 \text{ pF}, V_{IH} = V_{CC}, V_{IL} = 0V$ | 1.8             | 0.15                      | V     |
|                                   |                                      |   | 2.5             | 0.25                      |       |
|                                   |                                      |   | 3.3             | 0.35                      |       |
| $V_{OLV}$                         | Quiet Output Dynamic Valley $V_{OL}$ | $C_L = 30 \text{ pF}, V_{IH} = V_{CC}, V_{IL} = 0V$ | 1.8             | -0.15                     | V     |
|                                   |                                      |   | 2.5             | -0.25                     |       |
|                                   |                                      |   | 3.3             | -0.35                     |       |
| $V_{OHV}$                         | Quiet Output Dynamic Valley $V_{OH}$ | $C_L = 30 \text{ pF}, V_{IH} = V_{CC}, V_{IL} = 0V$ | 1.8             | 1.55                      | V     |
|                                   |                                      |   | 2.5             | 2.05                      |       |
|                                   |                                      |   | 3.3             | 2.65                      |       |

| Capacitance |                               |   |                           |       |
|-------------|-------------------------------|---|---------------------------|-------|
| Symbol      | Parameter                     | Conditions  | $T_A = +25^\circ\text{C}$ | Units |
|             |                               |   | Typical                   |       |
| $C_{IN}$    | Input Capacitance             | $V_{CC} = 1.8, 2.5V \text{ or } 3.3V, V_I = 0V \text{ or } V_{CC}$                      | 6                         | pF    |
| $C_{OUT}$   | Output Capacitance            | $V_I = 0V \text{ or } V_{CC}, V_{CC} = 1.8V, 2.5V \text{ or } 3.3V$                     | 7                         | pF    |
| $C_{PD}$    | Power Dissipation Capacitance | $V_I = 0V \text{ or } V_{CC}, f = 10 \text{ MHz}, V_{CC} = 1.8V, 2.5V \text{ or } 3.3V$ | 20                        | pF    |

## AC Loading and Waveforms

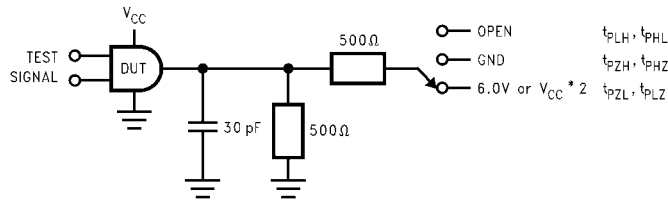

| TEST               | SWITCH   |
|--------------------|--|
| $t_{PLH}, t_{PHL}$ | Open   |
| $t_{PZL}, t_{PLZ}$ | 6V at $V_{CC} = 3.3 \pm 0.3V$ ;<br>$V_{CC} \times 2$ at $V_{CC} = 2.5 \pm 0.2V; 1.8 \pm 0.15V$ |
| $t_{PZH}, t_{PHZ}$ | GND  |

FIGURE 1. AC Test Circuit

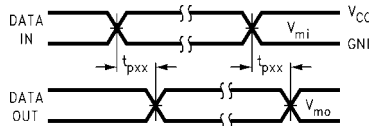

FIGURE 2. Waveform for Inverting and Non-Inverting Functions

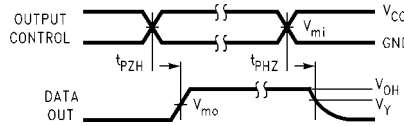

FIGURE 3. 3-STATE Output High Enable and Disable Times for Low Voltage Logic

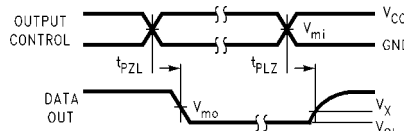
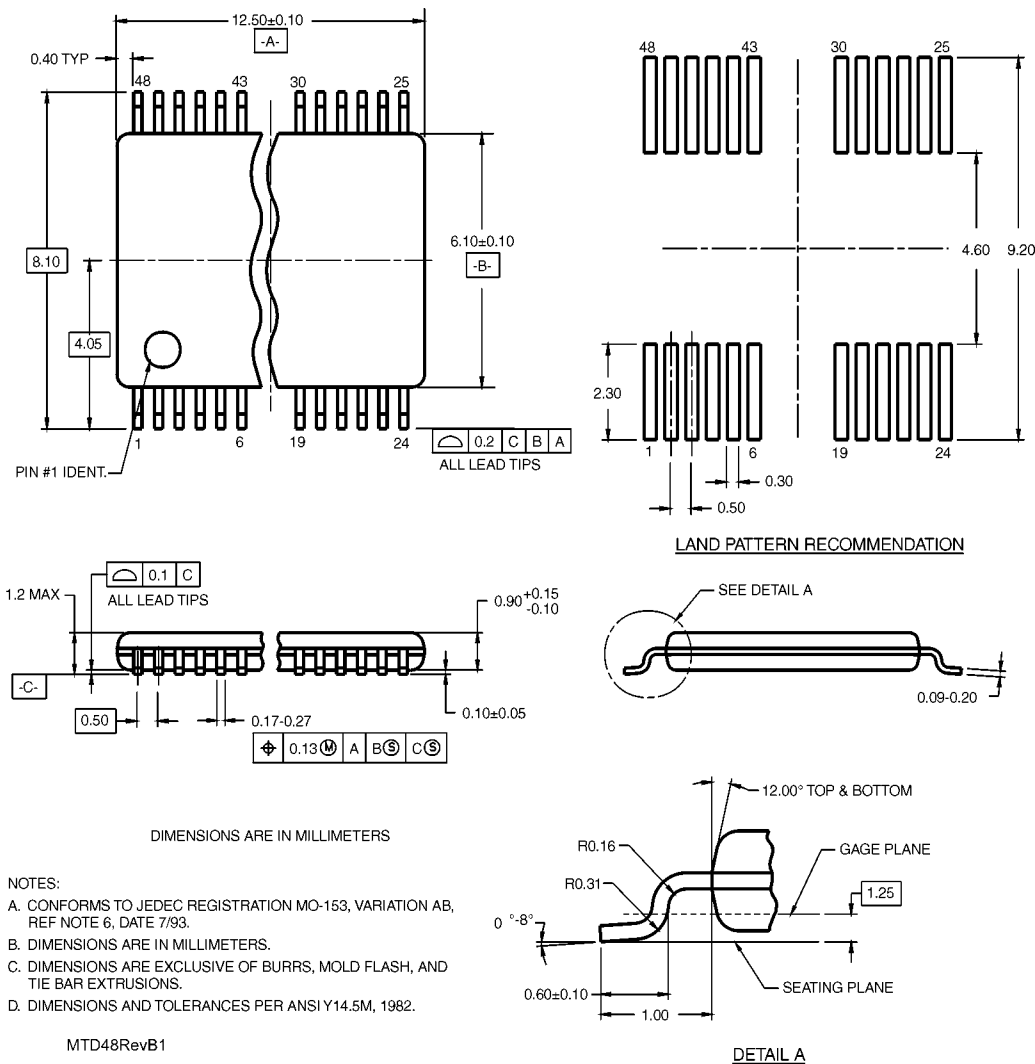

FIGURE 4. 3-STATE Output Low Enable and Disable Times for Low Voltage Logic

| Symbol   | $V_{CC}$        |                  |                  |
|----------|-----------------|------------------|------------------|
|          | $3.3V \pm 0.3V$ | $2.5V \pm 0.2V$  | $1.8V \pm 0.15V$ |
| $V_{mi}$ | 1.5V            | $V_{CC}/2$       | $V_{CC}/2$       |
| $V_{mo}$ | 1.5V            | $V_{CC}/2$       | $V_{CC}/2$       |
| $V_X$    | $V_{OL} + 0.3V$ | $V_{OL} + 0.15V$ | $V_{OL} + 0.15V$ |
| $V_Y$    | $V_{OH} - 0.3V$ | $V_{OH} - 0.15V$ | $V_{OH} - 0.15V$ |

**Physical Dimensions** inches (millimeters) unless otherwise noted



Fairchild does not assume any responsibility for use of any circuitry described, no circuit patent licenses are implied and Fairchild reserves the right at any time without notice to change said circuitry and specifications.

**LIFE SUPPORT POLICY**

FAIRCHILD'S PRODUCTS ARE NOT AUTHORIZED FOR USE AS CRITICAL COMPONENTS IN LIFE SUPPORT DEVICES OR SYSTEMS WITHOUT THE EXPRESS WRITTEN APPROVAL OF THE PRESIDENT OF FAIRCHILD SEMICONDUCTOR CORPORATION. As used herein:

1. Life support devices or systems are devices or systems which, (a) are intended for surgical implant into the body, or (b) support or sustain life, and (c) whose failure to perform when properly used in accordance with instructions for use provided in the labeling, can be reasonably expected to result in a significant injury to the user.
2. A critical component in any component of a life support device or system whose failure to perform can be reasonably expected to cause the failure of the life support device or system, or to affect its safety or effectiveness.

[www.fairchildsemi.com](http://www.fairchildsemi.com)