

# FSAV330

## Low On Resistance Quad SPDT Wide Bandwidth Video Switch

### General Description

The Fairchild Video Switch FSAV330 is a quad single pole/double throw high-speed CMOS TTL-compatible video switch. The low On Resistance of the switch allows inputs to be connected to outputs without adding propagation delay or generating additional ground bounce noise.

When  $\overline{OE}$  is LOW, the select pin connects the A Port to the selected B Port output. When  $\overline{OE}$  is HIGH, the switch is OPEN and a high-impedance state exists between the two ports.

### Features

- Replacement for the P15V330
- Wide bandwidth 180 MHz
- 4Ω switch connection between two ports
- Minimal propagation delay through the switch
- Low  $I_{CC}$
- Zero bounce in flow-through mode
- Control inputs compatible with TTL level

### Ordering Code:

Order Number	Package Number	Package Description
FSAV330M	M16A	16-Lead Small Outline Integrated Circuit (SOIC), JEDEC MS-012, 0.150" Narrow
FSAV330QSC	MQA16	16-Lead Quarter Size Outline Package (QSOP), JEDEC MO-137, 0.150" Wide
FSAV330MTC	MTC16	16-Lead Thin Shrink Small Outline Package (TSSOP), JEDEC MO-153, 4.4mm Wide

Device also available in Tape and Reel. Specify by appending suffix letter "X" to the ordering code.

### Logic Diagram

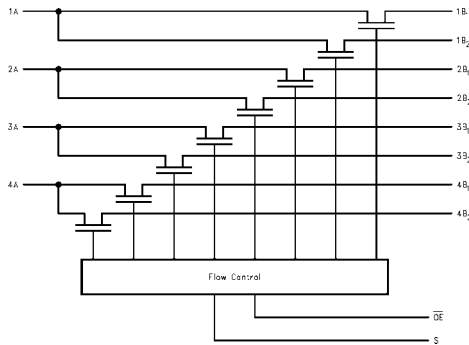

### Connection Diagram

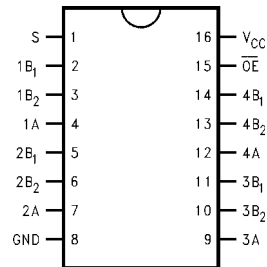

### Pin Descriptions

Pin Name	Description
$\overline{OE}$	Bus Switch Enable
S	Select Input
A	Bus A
B <sub>1</sub> -B <sub>2</sub>	Bus B

### Truth Table

S	$\overline{OE}$	Function
X	H	Disconnect
L	L	A = B <sub>1</sub>
H	L	A = B <sub>2</sub>

**Absolute Maximum Ratings** (Note 1)

Supply Voltage ( $V_{CC}$ )	-0.5V to +7.0V
DC Switch Voltage ( $V_S$ )	-0.5V to +7.0V
DC Input Voltage ( $V_{IN}$ ) (Note 2)	-0.5V to +7.0V
DC Input Diode Current ( $I_{IK}$ ) $V_{IN} < 0V$	-50 mA
DC Output ( $I_{OUT}$ ) Sink Current	128 mA
DC $V_{CC}/GND$ Current ( $I_{CC}/I_{GND}$ )	+/- 100 mA
Storage Temperature Range ( $T_{STG}$ )	-65°C to +150 °C

**Recommended Operating Conditions** (Note 3)

Power Supply Operating ( $V_{CC}$ )	4.0V to 5.5V
Input Voltage ( $V_{IN}$ )	0V to 5.5V
Output Voltage ( $V_{OUT}$ )	0V to 5.5V
Input Rise and Fall Time ( $t_r, t_f$ )	
Switch Control Input	0 ns/V to 5 ns/V
Switch I/O	0 ns/V to DC
Free Air Operating Temperature ( $T_A$ )	-40 °C to +85 °C

**Note 1:** The Absolute Maximum Ratings are those values beyond which the safety of the device cannot be guaranteed. The device should not be operated at these limits. The parametric values defined in the Electrical Characteristics tables are not guaranteed at the absolute maximum rating. The Recommended Operating Conditions tables will define the conditions for actual device operation.

**Note 2:** The input and output negative voltage ratings may be exceeded if the input and output diode current ratings are observed.

**Note 3:** Unused control inputs must be held HIGH or LOW. They may not float.

**DC Electrical Characteristics**

Symbol	Parameter	$V_{CC}$ (V)	$T_A = -40\text{ °C to }+85\text{ °C}$			Units	Conditions
			Min	Typ (Note 4)	Max		
	Analog Signal Range	5	0		2.0	V	
$V_{IK}$	Clamp Diode Voltage	4.5			-1.2	V	$I_{IN} = -18\text{ mA}$
$V_{IH}$	HIGH Level Input Voltage	4.0-5.5	2.0			V	
$V_{IL}$	LOW Level Input Voltage	4.0-5.5			0.8	V	
$I_I$	Input Leakage Current	5.5			$\pm 1.0$	$\mu A$	$0 \leq V_{IN} \leq 5.5V$
$I_{OFF}$	OFF-STATE Leakage Current	5.5			$\pm 1.0$	$\mu A$	$0 \leq A, B \leq V_{CC}$
$R_{ON}$	Switch On Resistance (Note 5)	4.5		3	7	$\Omega$	$V_{IN} = 1.0V$ $R_I = 75\ \Omega, I_{ON} = 13\text{ mA}$
		4.5		7	10	$\Omega$	$V_{IN} = 2.0V$ $R_I = 75\ \Omega, I_{ON} = 26\text{ mA}$
$I_{CC}$	Quiescent Supply Current	5.5			3	$\mu A$	$V_{IN} = V_{CC}$ or GND, $I_{OUT} = 0$
$\Delta I_{CC}$	Increase in $I_{CC}$ per Input	5.5			2.5	mA	One Input at 3.4V Other Inputs at $V_{CC}$ or GND

**Note 4:** Typical values are at  $V_{CC} = 5.0V$  and  $T_A = +25\text{ °C}$

**Note 5:** Measured by the voltage drop between A and B pins at the indicated current through the switch. On Resistance is determined by the lower of the voltages on the two (A or B) pins.

AC Electrical Characteristics									
Symbol	Parameter	T <sub>A</sub> = -40 °C to +85 °C, C <sub>L</sub> = 20 pF, R <sub>U</sub> = R <sub>D</sub> = 75Ω				Units	Conditions	Figure Number	
		V <sub>CC</sub> = 4.5 – 5.5V		V <sub>CC</sub> = 4.0V					
		Min	Typ	Max	Min				Max
t <sub>PZH</sub> , t <sub>PZL</sub>	Output Enable Time, Select to Bus B			5.2		5.7	ns	V <sub>I</sub> = 7V for t <sub>PZL</sub> V <sub>I</sub> = OPEN for t <sub>PZH</sub>	Figures 1, 2
	Output Enable Time, $\overline{\text{OE}}$ to Bus A, B			5.1		5.6			
t <sub>PHZ</sub> , t <sub>PLZ</sub>	Output Disable Time, Select to Bus B			5.2		5.5	ns	V <sub>I</sub> = 7V for t <sub>PLZ</sub> V <sub>I</sub> = OPEN for t <sub>PHZ</sub>	Figures 1, 2
	Output Disable Time, Output Enable Time $\overline{\text{OE}}$ to Bus A, B			5.5		5.5			
B <sub>W</sub> <sup>(1)</sup>	-3 dB Bandwidth	180					MHz	R <sub>L</sub> = 150Ω	
X <sub>TALK</sub>	Crosstalk		-58				dB	R <sub>IN</sub> = 10Ω, R <sub>L</sub> = 150Ω, 10 MHz	
D <sub>G</sub>	Differential Gain		0.64				%	R <sub>L</sub> = 150Ω, f = 3.58 MHz	
D <sub>P</sub>	Differential Phase		0.1				Deg.	R <sub>L</sub> = 150Ω, f = 3.58 MHz	
O <sub>IRR</sub>	Off Isolation		-60				dB	R <sub>L</sub> = 150Ω, 10 MHz	
<p><b>Note 6:</b> This parameter is guaranteed by design but is not tested. The bus switch contributes no propagation delay other than the RC delay of the typical On Resistance of the switch and the 20pF load capacitance, when driven by an ideal voltage the source (zero output impedance).</p>									
Capacitance (Note 7)									
Symbol	Parameter		Typ	Max	Units	Conditions			
C <sub>IN</sub>	Control Pin Input Capacitance		3		pF	V <sub>CC</sub> = 5.0V			
C <sub>I/O</sub>	A Port	Input/Output Capacitance	7		pF	V <sub>CC</sub> , $\overline{\text{OE}}$ = 5.0V			
	B Port		5		pF				
<p><b>Note 7:</b> T<sub>A</sub> = +25°C, f = 1 MHz, Capacitance is characterized but not tested.</p>									

## AC Loading and Waveforms

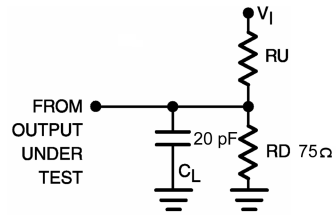

**Note:** Input driven by 50  $\Omega$  source terminated in 50  $\Omega$

**Note:**  $C_L$  includes load and stray capacitance

**Note:** Input PRR = 1.0 MHz,  $t_W$  = 500 ns

**FIGURE 1. AC Test Circuit**

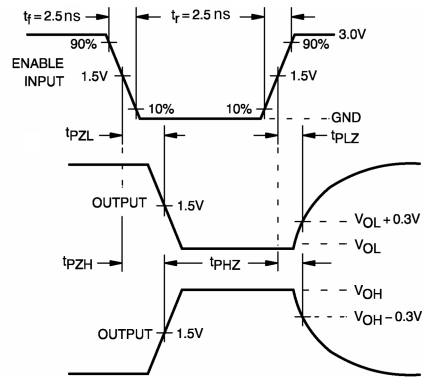

**FIGURE 2. AC Waveforms**

**Physical Dimensions** inches (millimeters) unless otherwise noted

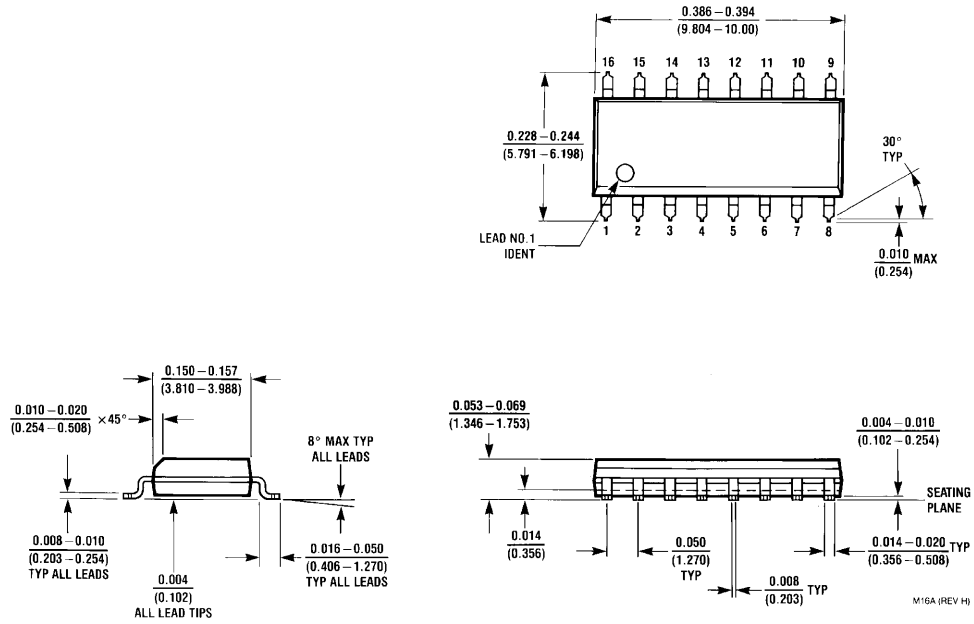

**16-Lead Small Outline Integrated Circuit (SOIC), JEDEC MS-012, 0.150" Narrow  
Package Number M16A**

**Physical Dimensions** inches (millimeters) unless otherwise noted (Continued)

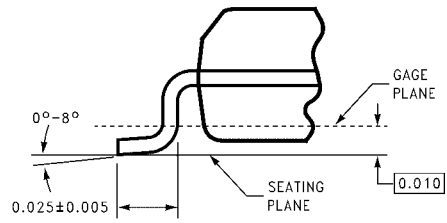
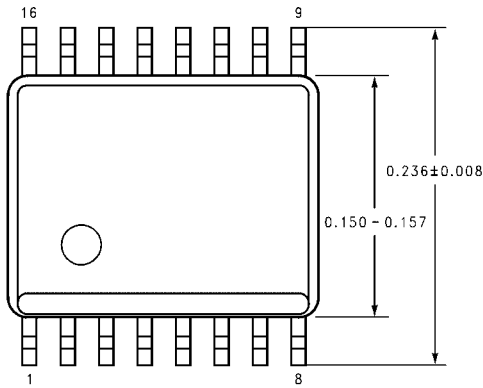

DETAIL A  
TYPICAL, SCALE: 40%

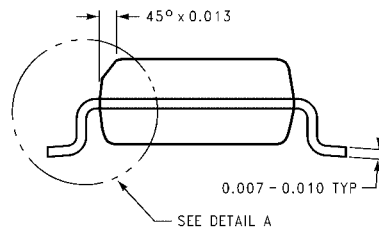
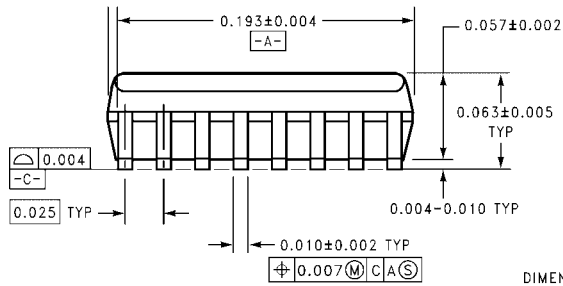

DIMENSIONS ARE IN INCHES

MQA16 (REV A)

**16-Lead Quarter Size Outline Package (QSOP), JEDEC MO-137, 0.150" Wide  
Package Number MQA16**

**Physical Dimensions** inches (millimeters) unless otherwise noted (Continued)

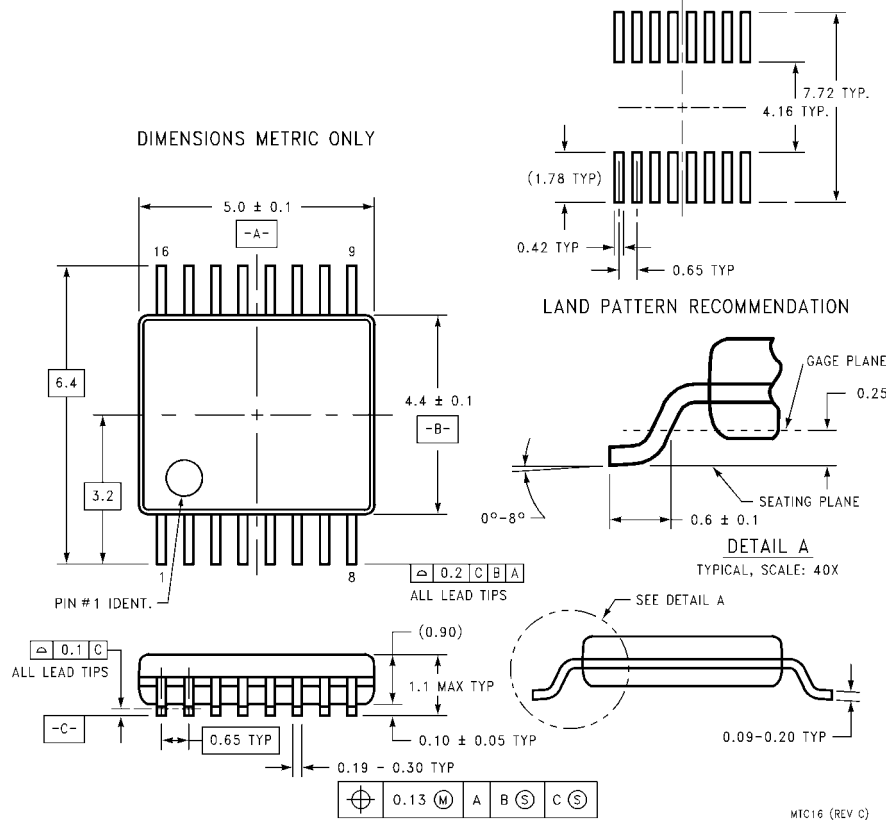

**16-Lead Thin Shrink Small Outline Package (TSSOP), JEDEC MO-153, 4.4mm Wide  
Package Number MTC16**

**Technology Description**

The Fairchild Switch family derives from and embodies Fairchild's proven switch technology used for several years in its 74LVX3L384 (FST3384) bus switch product.

Fairchild does not assume any responsibility for use of any circuitry described, no circuit patent licenses are implied and Fairchild reserves the right at any time without notice to change said circuitry and specifications.

**LIFE SUPPORT POLICY**

FAIRCHILD'S PRODUCTS ARE NOT AUTHORIZED FOR USE AS CRITICAL COMPONENTS IN LIFE SUPPORT DEVICES OR SYSTEMS WITHOUT THE EXPRESS WRITTEN APPROVAL OF THE PRESIDENT OF FAIRCHILD SEMICONDUCTOR CORPORATION. As used herein:

1. Life support devices or systems are devices or systems which, (a) are intended for surgical implant into the body, or (b) support or sustain life, and (c) whose failure to perform when properly used in accordance with instructions for use provided in the labeling, can be reasonably expected to result in a significant injury to the user.
2. A critical component in any component of a life support device or system whose failure to perform can be reasonably expected to cause the failure of the life support device or system, or to affect its safety or effectiveness.

[www.fairchildsemi.com](http://www.fairchildsemi.com)