

TUNNEL & SCHOTTKY DIODES

For

- Oscillators
- Detectors
- Amplifiers
- Switches

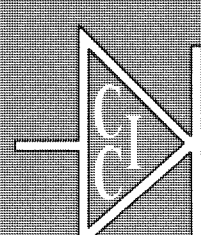
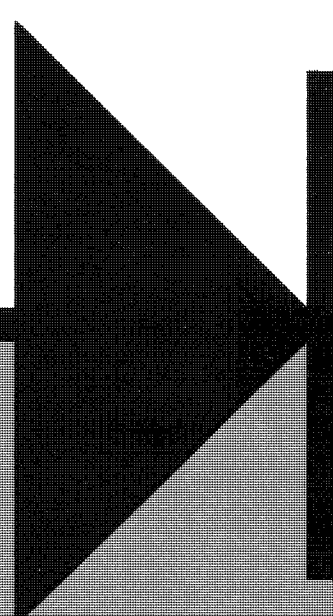
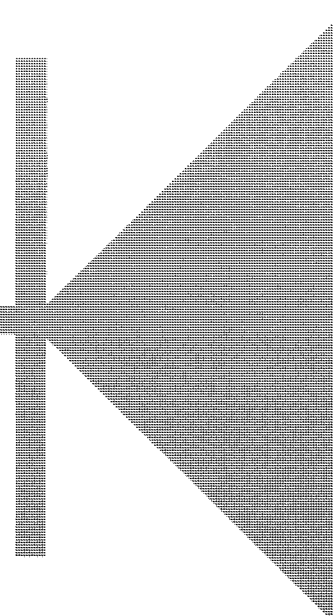
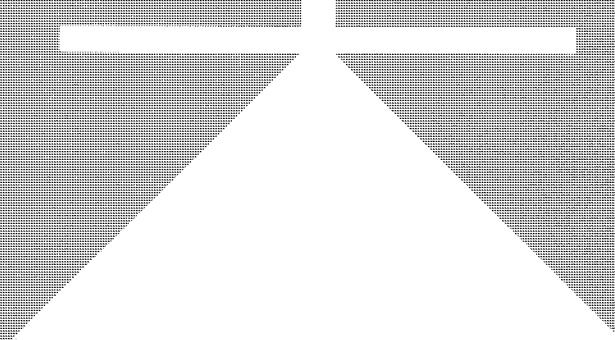

Custom Components, Inc.

Box 334, Lebanon, NJ 08833 • (201) 534-6151

• Fax 201-534-5625



OUTLINE DRAWINGS

Type 10

$L_p = 0.1nH$
 $C_p = .36pF$

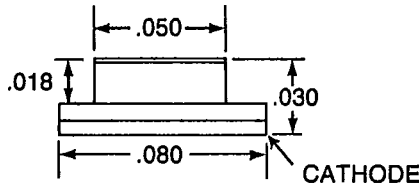

Type 11

$L_p = 0.1nH$
 $C_p = .36pF$

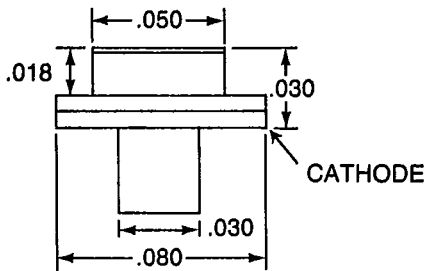

Type 13

$L_p = 0.3nH$
 $C_p = .35pF$

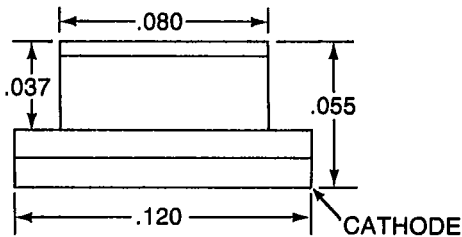

Type 15

$L_p = 0.5nH$
 $C_p = .45pF$

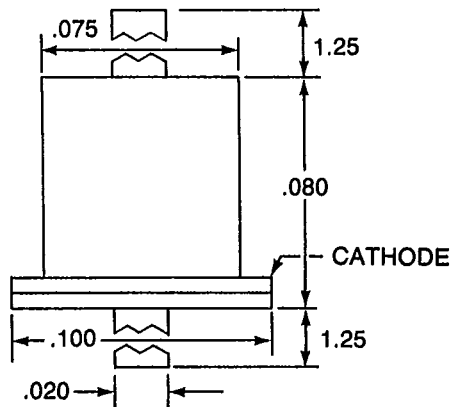

Type 21

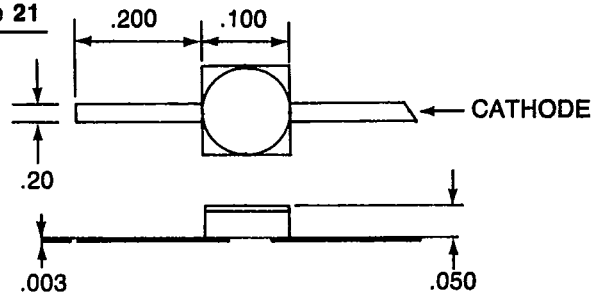

Type 23

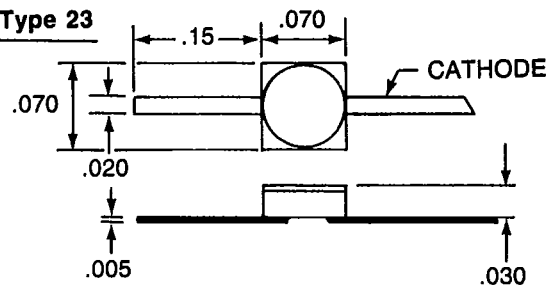

Type 25

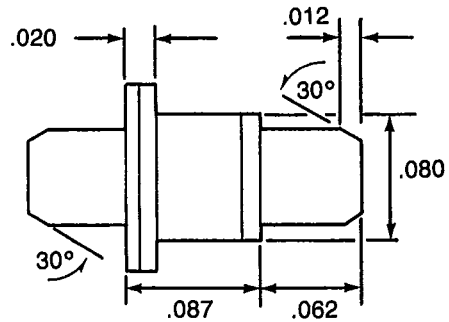

Type 28

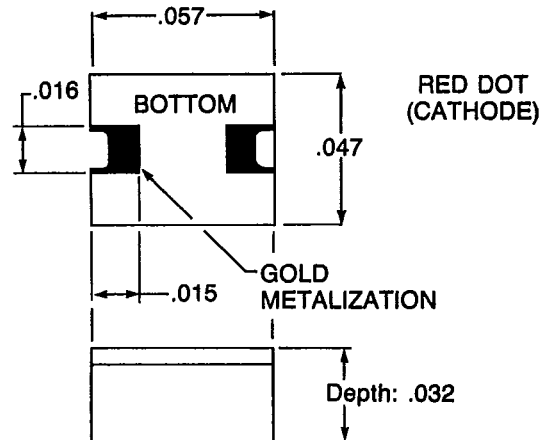

NOTE:
Use package number as prefix to
part number, i.e. 23HR400BD