



MOTOROLA

T-50-17

MC14046B

PHASE LOCKED LOOP

The MC14046B phase locked loop contains two phase comparators, a voltage-controlled oscillator (VCO), source follower, and zener diode. The comparators have two common signal inputs, PCA_{in} and PCB_{in}. Input PCA_{in} can be used directly coupled to large voltage signals, or indirectly coupled (with a series capacitor) to small voltage signals. The self-bias circuit adjusts small voltage signals in the linear region of the amplifier. Phase comparator 1 (an exclusive OR gate) provides a digital error signal PC1_{out}, and maintains 90° phase shift at the center frequency between PCA_{in} and PCB_{in} signals (both at 50% duty cycle). Phase comparator 2 (with leading edge sensing logic) provides digital error signals, PC2_{out} and LD, and maintains a 0° phase shift between PCA_{in} and PCB_{in} signals (duty cycle is immaterial). The linear VCO produces an output signal VCO_{out} whose frequency is determined by the voltage of input VCO_{in} and the capacitor and resistors connected to pins C1A, C1B, R1, and R2. The source-follower output SF_{out} with an external resistor is used where the VCO_{in} signal is needed but no loading can be tolerated. The inhibit input Inh, when high, disables the VCO and source follower to minimize standby power consumption. The zener diode can be used to assist in power supply regulation.

Applications include FM and FSK modulation and demodulation, frequency synthesis and multiplication, frequency discrimination, tone decoding, data synchronization and conditioning, voltage-to-frequency conversion and motor speed control.

- VCO Frequency = 1.4 MHz Typical @ V_{DD} = 10 V
- VCO Frequency Drift with Temperature = 0.04%/°C Typical @ V_{DD} = 10 V
- VCO Linearity = 1% Typical
- Quiescent Current = 5.0 nA/package typical @ 5 V
- Low Dynamic Power Dissipation - 70 μW Typical @ f₀ = 10 kHz, V_{DD} = 5.0 V, R1 = 1.0 MΩ, R2 = ∞, R_{SF} = ∞
- Buffered Outputs Compatible with MHTL and Low-Power TTL
- Diode Protection on All Inputs
- Supply Voltage Range = 3.0 to 18 V
- Pin-for-Pin Replacement for CD4046B
- Phase Comparator 1 is an Exclusive Or Gate and is Duty Cycle Limited
- Phase Comparator 2 switches on Rising Edges and is not Duty Cycle Limited

CMOS MSI

(LOW-POWER COMPLEMENTARY MOS)

PHASE LOCKED LOOP

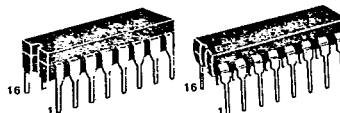

L SUFFIX
CERAMIC PACKAGE
CASE 620

P SUFFIX
PLASTIC PACKAGE
CASE 648

ORDERING INFORMATION

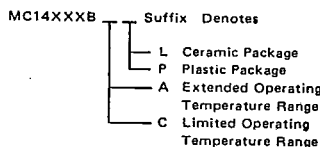

BLOCK DIAGRAM

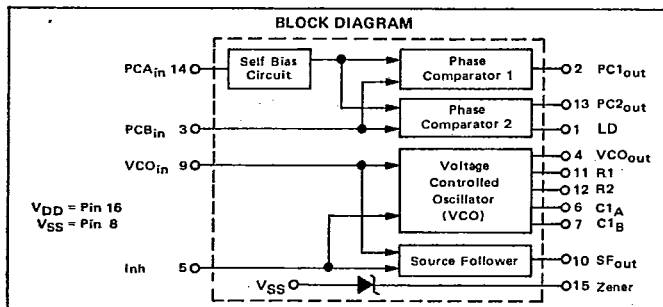

PIN ASSIGNMENT

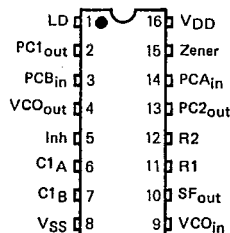

MC14046B

MAXIMUM RATINGS (Voltages referenced to V_{SS})

Rating	Symbol	Value	Unit
DC Supply Voltage	V _{DD}	-0.5 to +18	Vdc
Input Voltage, All Inputs	V _{in}	-0.5 to V _{DD} + 0.5	Vdc
DC Input Current, per Pin	I _{in}	±10	mAdc
Operating Temperature Range - AL Device	T _A	-55 to +125	°C
CL/CP Device		-40 to +85	
Storage Temperature Range	T _{stg}	-65 to +150	°C

ELECTRICAL CHARACTERISTICS (Voltages Referenced to V_{SS})

Characteristic	Symbol	V _{DD} Vdc	T _{low} *		25°C			T _{high} *		Unit	
			Min	Max	Min	Typ	Max	Min	Max		
Output Voltage V _{in} = V _{DD} or 0	"0" Level V _{OL}	5.0	-	0.05	-	0	0.05	-	0.05	V	
		10	-	0.05	-	0	0.05	-	0.05		
		15	-	0.05	-	0	0.05	-	0.05		
	"1" Level V _{in} = 0 or V _{DD}	V _{OH}	5.0	4.95	-	4.95	5.0	-	4.95	-	V
			10	9.95	-	9.95	10	-	9.95	-	
			15	14.95	-	14.95	15	-	14.95	-	
Input Voltage [†] (V _O = 4.5 or 0.5 V) (V _O = 9.0 or 1.0 V) (V _O = 13.5 or 1.5 V)	"0" Level V _{IL}	5.0	-	1.5	-	2.25	1.5	-	1.5	V	
		10	-	3.0	-	4.50	3.0	-	3.0		
		15	-	4.0	-	6.75	4.0	-	4.0		
	"1" Level (V _O = 0.5 or 4.5 V) (V _O = 1.0 or 9.0 V) (V _O = 1.5 or 13.5 V)	V _{IH}	5.0	3.5	-	3.5	2.75	-	3.5	-	V
			10	7.0	-	7.0	5.50	-	7.0	-	
			15	11.0	-	11.0	8.25	-	11.0	-	
Output Drive Current (AL Device) (V _{OH} = 2.5 V) (V _{OH} = 4.6 V) (V _{OH} = 9.5 V) (V _{OH} = 13.5 V) (V _{OL} = 0.4 V) (V _{OL} = 0.5 V) (V _{OL} = 1.5 V)	Source I _{OH}	5.0	-1.2	-	-1.0	-1.7	-	-0.7	-	mA	
		5.0	-0.25	-	-0.2	-0.36	-	-0.14	-		
		10	-0.62	-	-0.5	-0.9	-	-0.36	-		
		15	-1.8	-	-1.5	-3.5	-	-1.1	-		
		5.0	0.64	-	0.51	0.88	-	0.36	-		
		15	4.2	-	1.3	2.25	-	0.9	-		
	Sink I _{OL}	5.0	0.64	-	0.51	0.88	-	0.36	-	mA	
		10	1.6	-	1.3	2.25	-	0.9	-		
		15	4.2	-	3.4	8.8	-	2.4	-		
		5.0	-1.0	-	-0.8	-1.7	-	-0.6	-		mA
		5.0	-0.2	-	-0.16	-0.36	-	-0.12	-		
		10	-0.5	-	-0.4	-0.9	-	-0.3	-		
15	-1.4	-	-1.2	-3.5	-	-1.0	-				
5.0	0.52	-	0.44	0.88	-	0.36	-				
15	3.6	-	3.0	8.8	-	2.4	-				
Input Current (AL Device)	I _{in}	15	-	±0.1	-	±0.00001	±0.1	-	±1.0	µA	
Input Current (CL/CP Device)	I _{in}	15	-	±0.3	-	±0.00001	±0.3	-	±1.0	µA	
Input Capacitance	C _{in}	-	-	-	-	5.0	7.5	-	-	pF	
Quiescent Current (AL Device) (Per Package) I _{nh} = PCA _{in} = V _{DD} , Zener = VCO _{in} = 0 V, PCB _{in} = V _{DD} or 0 V, I _{out} = 0 µA	I _{DD}	5.0	-	5.0	-	0.005	5.0	-	150	µA	
		10	-	10	-	0.010	10	-	300		
		15	-	20	-	0.015	20	-	600		
Quiescent Current (CL/CP Device) (Per Package) I _{nh} = PCA _{in} = V _{DD} , Zener = VCO _{in} = 0 V, PCB _{in} = V _{DD} or 0 V, I _{out} = 0 µA	I _{DD}	5.0	-	20	-	0.010	20	-	150	µA	
		10	-	40	-	0.020	40	-	300		
		15	-	80	-	0.040	80	-	600		
Total Supply Current † (I _{nh} = "0", f _o = 10 kHz, C _L = 50 pF, R1 = 1 MΩ, R2 = ∞, R _{SF} = ∞, and 50% Duty Cycle)	I _T	5.0	I _T = (1.46 µA/kHz) f + I _{DD}							µA	
		10	I _T = (2.91 µA/kHz) f + I _{DD}								
		15	I _T = (4.37 µA/kHz) f + I _{DD}								

*T_{low} = -55°C for AL Device, -40°C for CL/CP Device.
 T_{high} = +125°C for AL Device, +85°C for CL/CP Device.
 †Noise immunity specified for worst-case input combination.
 Noise Margin for both "1" and "0" level = 1.0 Vdc min @ V_{DD} = 5.0 Vdc
 2.0 Vdc min @ V_{DD} = 10 Vdc
 2.5 Vdc min @ V_{DD} = 15 Vdc

†To Calculate Total Current in General:

$$I_T \approx 2.2 \times V_{DD} \left(\frac{V_{COin} - 1.65}{R1} + \frac{V_{DD} - 1.35}{R2} \right)^{3/4} + 1.6 \times \left(\frac{V_{COin} - 1.65}{R_{SF}} \right)^{3/4} + 1 \times 10^{-3} (C_L + 9) V_{DD} f + 1 \times 10^{-1} V_{DD}^2 \left(\frac{100\% \text{ Duty Cycle of PCA}_{in}}{100} \right) + I_Q$$

where: I_T in µA, C_L in pF, VCO_{in}, V_{DD} in Vdc, f in KHz, and R1, R2, R_{SF} in MΩ, C_L on VCO_{out}.

MC14046B

ELECTRICAL CHARACTERISTICS* (C_L = 50 pF, T_A = 25°C)

Characteristic	Symbol	V _{DD} Vdc	Minimum		Typical All Types	Maximum		Units
			AL Device	CL/CP Device		AL Device	CL/CP Device	
Output Rise Time t _{TLH} = (3.0 ns/pF) C _L + 30 ns t _{TLH} = (1.5 ns/pF) C _L + 15 ns t _{TLH} = (1.1 ns/pF) C _L + 10 ns	t _{TLH}	5.0 10 15	— — —	— — —	180 90 65	350 150 110	400 200 160	ns
Output Fall Time t _{THL} = (1.5 ns/pF) C _L + 25 ns t _{THL} = (0.75 ns/pF) C _L + 12.5 ns t _{THL} = (0.55 ns/pF) C _L + 9.5 ns	t _{THL}	5.0 10 15	— — —	— — —	100 50 37	175 75 55	200 100 80	ns

PHASE COMPARATORS 1 and 2

Input Resistance — PCA _{in}	R _{in}	5.0	1.0	1.0	2.0	—	—	MΩ
		10	0.2	0.2	0.4	—	—	
		15	0.1	0.1	0.2	—	—	
— PCB _{in}	R _{in}	15	150	15	1500	—	—	MΩ
Minimum Input Sensitivity AC Coupled — PCA _{in} C series = 1000 pF, f = 50 kHz	V _{in}	5.0	—	—	200	300	400	mV p-p
		10	—	—	400	600	800	
		15	—	—	700	1050	1400	
DC Coupled — PCA _{in} , PCB _{in}	—	5 to 15	See Noise Immunity					

VOLTAGE CONTROLLED OSCILLATOR (VCO)

Maximum Frequency (VCO _{in} = V _{DD} , C1 = 50 pF, R1 = 5 kΩ, and R2 = ∞)	f _{max}	5.0	0.50	0.35	0.70	—	—	MHz
		10	1.0	0.7	1.4	—	—	
		15	1.4	1.0	1.9	—	—	
Temperature — Frequency Stability (R2 = ∞)	—	5.0	—	—	0.12	—	—	%°C
		10	—	—	0.04	—	—	
		15	—	0	0.015	—	10	
Linearity (R2 = ∞) (VCO _{in} = 2.50 V ± 0.30 V, R1 ≥ 10 kΩ) (VCO _{in} = 5.00 V ± 2.50 V, R1 ≥ 400 kΩ) (VCO _{in} = 7.50 V ± 5.00 V, R1 ≥ 1000 kΩ)	—	5.0	—	—	1	—	—	%
		10	—	—	1	—	—	
		15	—	—	1	—	—	
Output Duty Cycle	—	5 to 15	—	—	50	—	—	%
Input Resistance — VCO _{in}	R _{in}	15	150	50	1500	—	—	MΩ



SOURCE-FOLLOWER

Offset Voltage (VCO _{in} minus SF _{out} , R _{SF} > 500 kΩ)	—	5.0	—	—	1.65	2.2	2.5	V
		10	—	—	1.65	2.2	2.5	
		15	—	—	1.65	2.2	2.5	
Linearity (VCO _{in} = 2.50 V ± 0.30 V, R _{SF} > 50 kΩ) (VCO _{in} = 5.00 V ± 2.50 V, R _{SF} > 50 kΩ) (VCO _{in} = 7.50 V ± 6.00 V, R _{SF} > 50 kΩ)	—	5.0	—	—	0.1	—	—	%
		10	—	—	0.6	—	—	
		15	—	—	0.8	—	—	

ZENER DIODE

Zener Voltage (I _Z = 50 μA)	V _Z	—	6.7	6.3	7.0	7.3	7.7	V
Dynamic Resistance (I _Z = 1 mA)	R _Z	—	—	—	100	—	—	Ω

*The formula given is for the typical characteristics only.

MC14046B

FIGURE 1 - PHASE COMPARATORS STATE DIAGRAMS

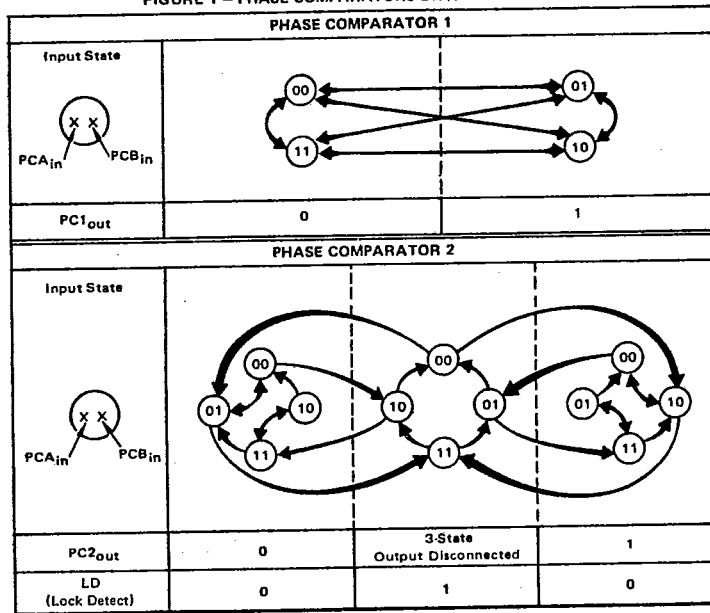

Refer to Waveforms in Figure 3.

FIGURE 2 - DESIGN INFORMATION

Characteristic	Using Phase Comparator 1	Using Phase Comparator 2
No signal on input PCA _{in} .	VCO in PLL system adjusts to center frequency (f ₀).	VCO in PLL system adjusts to minimum frequency (f _{min}).
Phase angle between PCA _{in} and PCB _{in} .	90° at center frequency (f ₀), approaching 0° and 180° at ends of lock range (2f _L).	Always 0° in lock (positive rising edges).
Locks on harmonics of center frequency.	Yes	No
Signal input noise rejection.	High	Low
Lock frequency range (2f _L).	The frequency range of the input signal on which the loop will stay locked if it was initially in lock. 2f _L = full VCO frequency range = f _{max} - f _{min} .	
Capture frequency range (2f _C).	The frequency range of the input signal on which the loop will lock if it was initially out of lock.	
	Depends on low-pass filter characteristics (see Figure 3). f _C < f _L	f _C = f _L
Center frequency (f ₀).	The frequency of VCO _{out} , when VCO _{in} = 1/2 VDD	
VCO output frequency (f).	$f_{min} = \frac{1}{R_2(C_1 + 32 \text{ pF})} \quad (\text{VCO input} = V_{SS})$ $f_{max} = \frac{1}{R_1(C_1 + 32 \text{ pF})} + f_{min} \quad (\text{VCO input} = V_{DD})$ <p>Where: 10K < R₁ < 1M 10K < R₂ < 1M 100pF < C₁ < .01 μF</p>	

Note: These equations are intended to be a design guide. Since calculated component values may be in error by as much as a factor of 4, laboratory experimentation may be required for fixed designs. Part to part frequency variation with identical passive components is less than ±20%.

MC14046B

FIGURE 3 - GENERAL PHASE-LOCKED LOOP CONNECTIONS AND WAVEFORMS

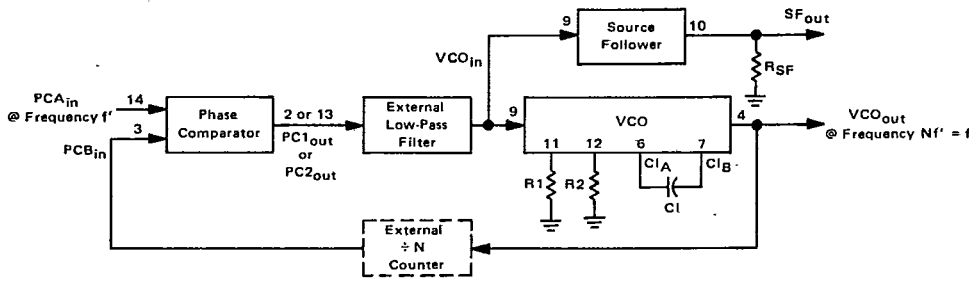

Typical Low-Pass Filters

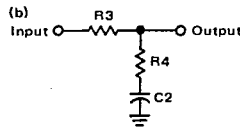
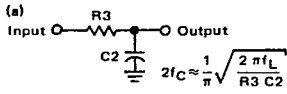

Typically:

$$R_4 C_2 = \frac{6N}{f_{max}} - \frac{N}{2\pi \Delta f}$$

$$(R_3 + 3,000\Omega) C_2 = \frac{100N\Delta f}{f_{max}^2} - R_4 C_2$$

$$\Delta f = f_{max} - f_{min}$$

Note: Sometimes R3 is split into two series resistors each R3 ÷ 2. A capacitor C_C is then placed from the midpoint to ground. The value for C_C should be such that the corner frequency of this network does not significantly affect ω_n. In Figure B, the ratio of R3 to R4 sets the damping, R4 ≈ (0.1)(R3) for optimum results.

Definitions: N = Total division ratio in feedback loop
 K_φ = V_{DD}/π for Phase Comparator 1
 K_φ = V_{DD}/4π for Phase Comparator 2
 $K_{VCO} = \frac{2\pi \Delta f_{VCO}}{V_{DD} - 2V}$
 for a typical design ω_n ≈ $\frac{2\pi f_r}{10}$ (at phase detector input)
 ζ ≈ 0.707

LOW-PASS FILTER

Filter A	Filter B
$\omega_n = \sqrt{\frac{K_\phi K_{VCO}}{NR_3 C_2}}$	$\omega_n = \sqrt{\frac{K_\phi K_{VCO}}{NC_2(R_3 + R_4)}}$
$\zeta = \frac{N\omega_n}{2K_\phi K_{VCO}}$	$\zeta = 0.5 \omega_n (R_3 C_2 + \frac{N}{K_\phi K_{VCO}})$
$F(s) = \frac{1}{R_3 C_2 s + 1}$	$F(s) = \frac{R_3 C_2 s + 1}{s(R_3 C_2 + R_4 C_2) + 1}$

Waveforms

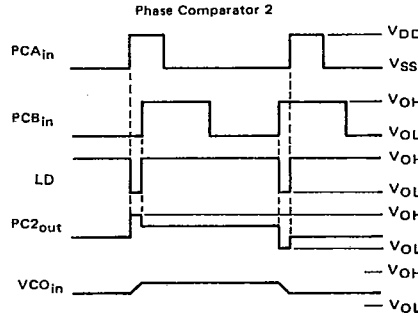
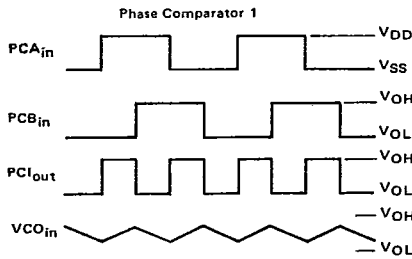

Note: for further information, see:

- (1) F. Gardner, "Phase-Lock Techniques", John Wiley and Son, New York, 1966.
- (2) G. S. Moschytz, "Miniature RC Filters Using Phase-Locked Loop", BSTJ, May, 1965.
- (3) Garth Nash, "Phase-Lock Loop Design Fundamentals", AN-535, Motorola Inc.