

### Typical Applications

- General Purpose High Bandwidth Gain Blocks
- IF or RF Buffer Amplifiers
- Broadband Test Equipment
- Final PA for Medium Power Applications
- Driver Stage for Power Amplifiers

### Product Description

The RF2310 is a general purpose, low-cost, high linearity RF amplifier IC. The device is manufactured on an advanced Gallium Arsenide Heterojunction Bipolar Transistor (HBT) process, and has been designed for use as an easily cascadable 50Ω gain block. Applications include IF and RF amplification in wireless voice and data communication products operating in frequency bands up to 2500MHz. The gain flatness over a very wide bandwidth makes the device suitable for many applications. The device is self-contained with 50Ω input and output impedances and requires only two external DC biasing elements to operate as specified.

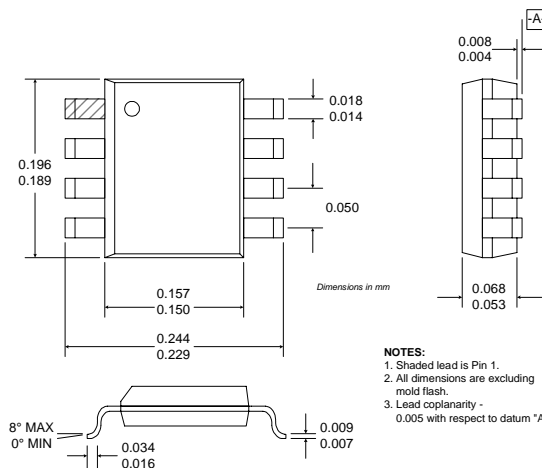

### Optimum Technology Matching® Applied

- |                                     |  |                                      |
|-------------------------------------|--|--------------------------------------|
| <input type="checkbox"/> Si BJT     | <input checked="" type="checkbox"/> GaAs HBT | <input type="checkbox"/> GaAs MESFET |
| <input type="checkbox"/> Si Bi-CMOS | <input type="checkbox"/> SiGe HBT            | <input type="checkbox"/> Si CMOS     |

Package Style: SOIC-8

### Features

- DC to well over 2500MHz Operation
- Internally Matched Input and Output
- 15dB Small Signal Gain
- 5dB Noise Figure
- +19dBm Output Power
- Single 3.5V to 6V Positive Power Supply

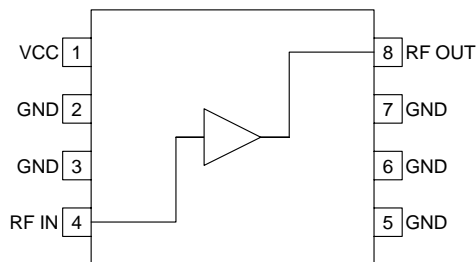

Functional Block Diagram

### Ordering Information

RF2310	Wideband General Purpose Amplifier
RF2310 PCBA	Fully Assembled Evaluation Board

 RF Micro Devices, Inc.  
 7628 Thorndike Road  
 Greensboro, NC 27409, USA

 Tel (336) 664 1233  
 Fax (336) 664 0454  
<http://www.rfmd.com>

# RF2310

## Absolute Maximum Ratings

Parameter	Rating	Unit
Supply Voltage	-0.5 to +6.0	V <sub>DC</sub>
Input RF Power	+10	dBm
Storage Temperature	-40 to +150	°C
Junction Temperature	175	°C
Thermal Resistance, Junction to Case	179	°C/W



**Caution!** ESD sensitive device.

RF Micro Devices believes the furnished information is correct and accurate at the time of this printing. However, RF Micro Devices reserves the right to make changes to its products without notice. RF Micro Devices does not assume responsibility for the use of the described product(s).

Notes: case reference: pins 5-7, conditions: no signal in and both RF ports terminated in 50Ω; average junction temperature measured at 85°C ambient: 143°C

4

GENERAL PURPOSE  
AMPLIFIERS

Parameter	Specification			Unit	Condition
	Min.	Typ.	Max.		
<b>Operating Range</b>					
Overall Frequency Range	100		2500	MHz	V <sub>CC</sub> =3.6V, Temp=27°C V <sub>CC</sub> =5V, Temp=27°C
Supply Voltage	3.5		6.0	V	
Operating Current (I <sub>CC</sub> )		20	25	mA	
	40	50	65	mA	
Operating Ambient Temperature	-40		+85	°C	
<b>3.6V Performance</b>					
Gain		16.2		dB	Freq=300MHz, V <sub>CC</sub> =3.6V, Temp=27°C
Gain		15.3		dB	Freq=900MHz, V <sub>CC</sub> =3.6V, Temp=27°C
Noise Figure		2.5		dB	
Output IP3		+22.0		dBm	
OP1dB		+10		dBm	
Gain		15		dB	Freq=1950MHz, V <sub>CC</sub> =3.6V, Temp=27°C
Noise Figure		2.7		dB	
Output IP3		+23.0		dBm	
OP1dB		+10		dBm	
Gain		16		dB	Freq=2450MHz, V <sub>CC</sub> =3.6V, Temp=27°C
Noise Figure		2.4		dB	
Output IP3		+21.0		dBm	
OP1dB		+10		dBm	
<b>5V Performance</b>					
Gain		17		dB	Freq=300MHz, V <sub>CC</sub> =5V, Temp=27°C
Gain	14.0	16.5		dB	Freq=900MHz, V <sub>CC</sub> =5V, Temp=27°C
Noise Figure		3		dB	
Output IP3	+28.0	+31.0		dBm	
OP1dB		+17		dBm	
Gain		15.6		dB	Freq=1950MHz, V <sub>CC</sub> =5V, Temp=27°C
Noise Figure		3.5		dB	
Output IP3		+33.0		dBm	
OP1dB		+18		dBm	
Gain		15		dB	Freq=2450MHz, V <sub>CC</sub> =5V, Temp=27°C
Noise Figure		2.8		dB	
Output IP3		+26.0		dBm	
OP1dB		+17		dBm	

Pin	Function	Description	Interface Schematic
1	VCC	Power supply pin. An external bypass capacitor is recommended. The total supply current is shared between this pin and pin 8 (through the inductor).	
2	GND	Ground connection. For best performance, keep traces physically short and connect immediately to ground plane. To achieve the performance as specified, and to minimize instability, it is recommended to have a local ground plane under the device, as shown in the evaluation board layout.	
3	GND	Same as pin 2.	
4	RF IN	RF input pin. This pin is NOT internally DC-blocked. A DC-blocking capacitor, suitable for the frequency of operation, should be used in most applications. DC-coupling of the input is not allowed, because this will override the internal feedback loop and cause temperature instability.	
5	GND	Same as pin 2.	
6	GND	Same as pin 2.	
7	GND	Same as pin 2.	
8	RF OUT	RF output and bias pin. Biasing is accomplished with an external choke inductor to V <sub>CC</sub> that provides high impedance at the operating frequency. Because DC is present on this pin, a DC-blocking capacitor, suitable for the frequency of operation, should be used in most applications. The supply side of the bias network should also be well bypassed.	

## Application Schematic

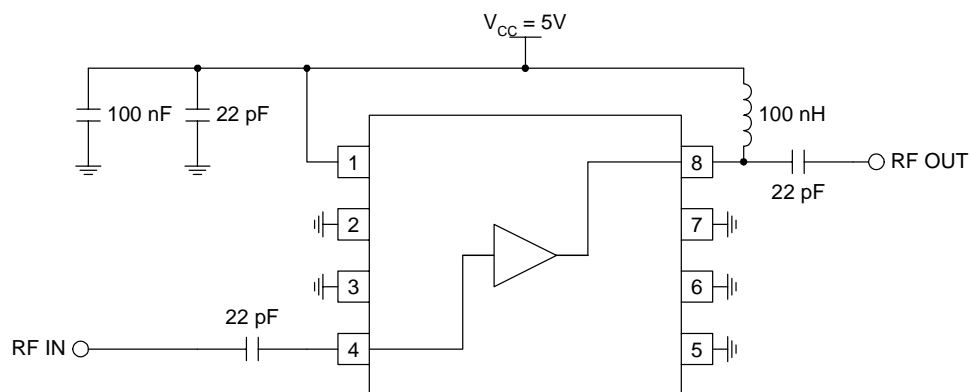

# RF2310

## Evaluation Board Schematic

(Download [Bill of Materials](http://www.rfmd.com) from [www.rfmd.com](http://www.rfmd.com).)

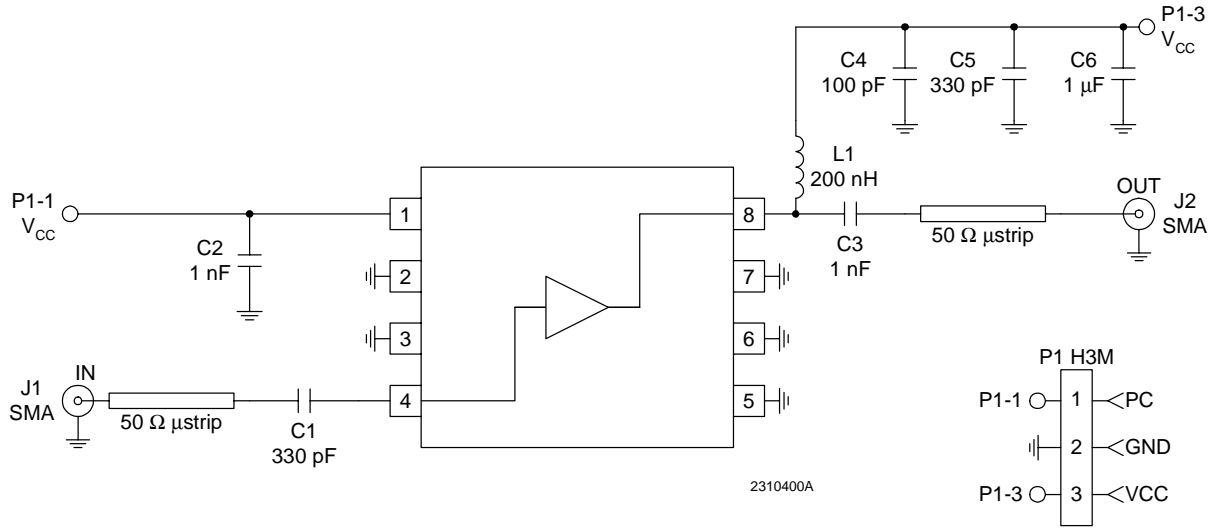

4

GENERAL PURPOSE  
AMPLIFIERS

## Evaluation Board Layout Board Size 2.02" x 2.02" Board Thickness 0.031", Board Material FR-4

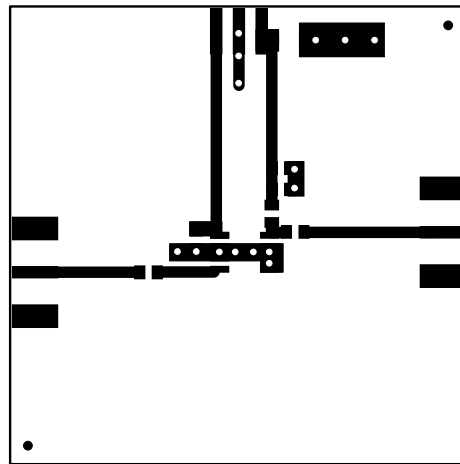
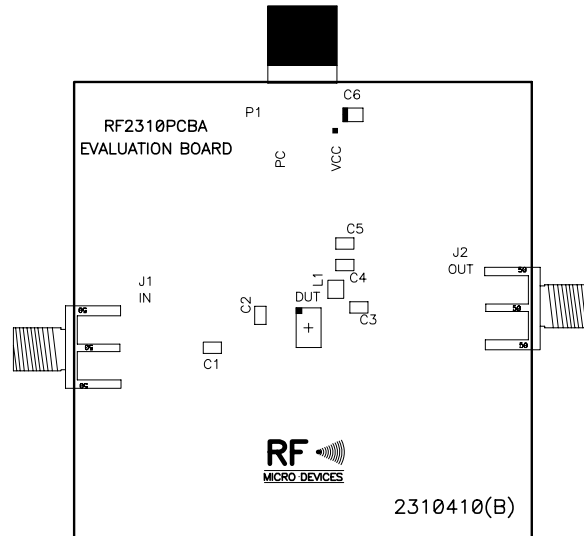

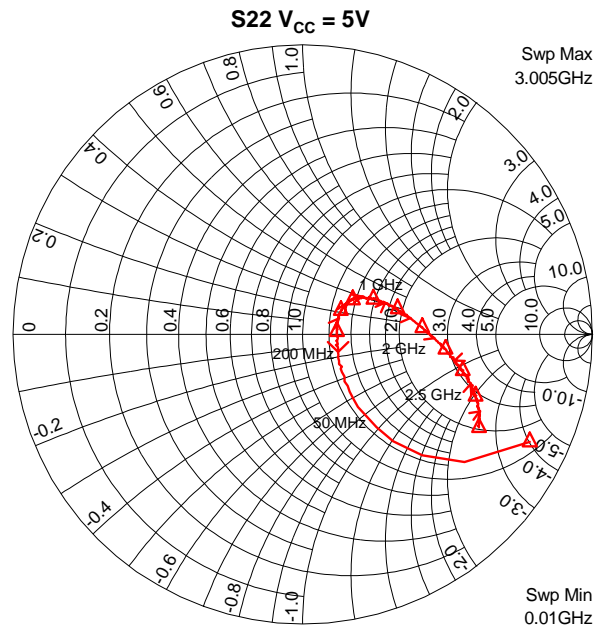
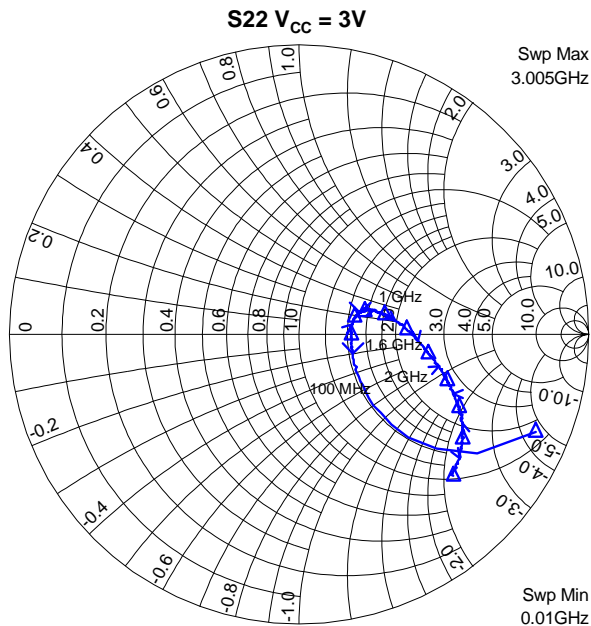
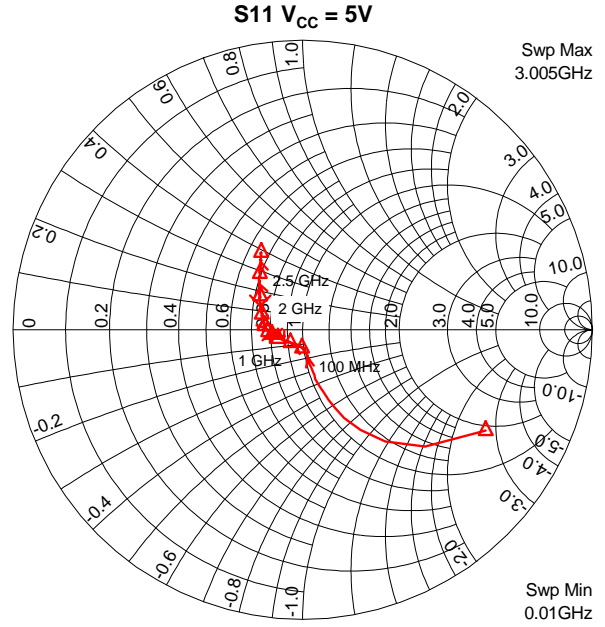
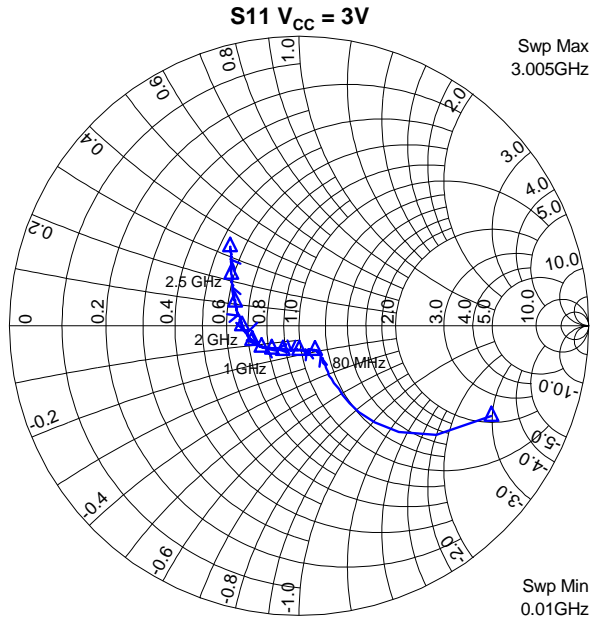

S-Parameter Conditions:  
All plots are taken at ambient temperature=25°C.

NOTE:  
All S11 and S22 plots shown were taken from an RF2310 evaluation board with external input and output tuning components removed and the reference points at the RF IN and RF OUT pins.

**Gain versus Temperature**  
Frequency = 900 MHz

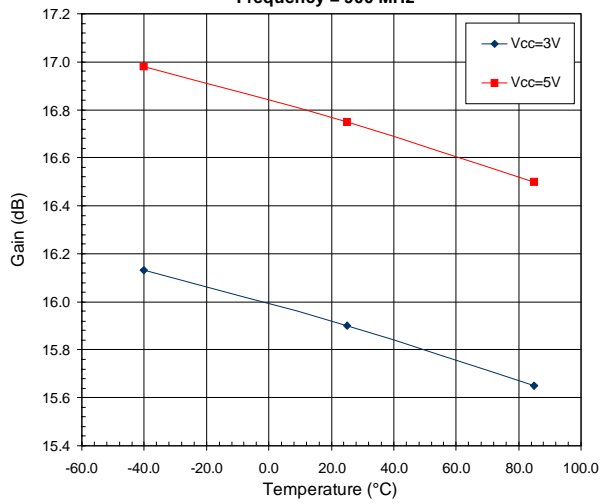

**OIP3 versus Temperature**  
Frequency = 900 MHz

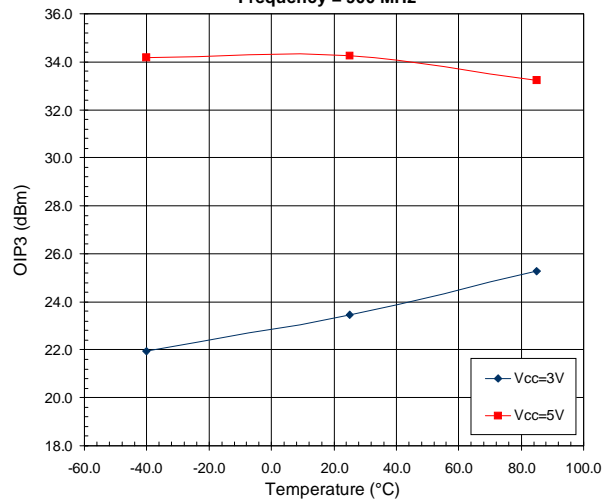

**OP1dB versus Temperature**  
Frequency = 900 MHz

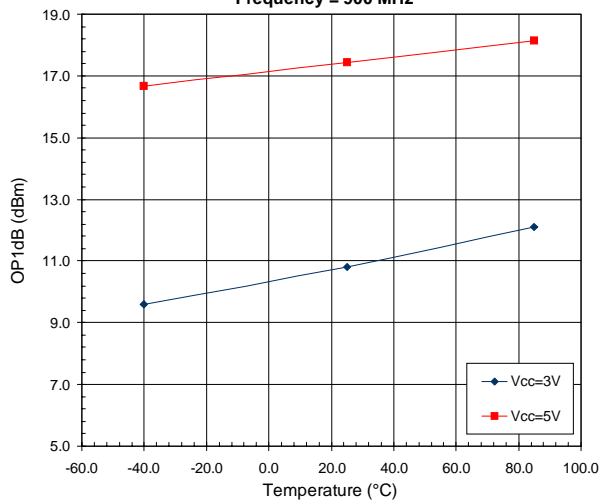

**I<sub>CC</sub> versus Temperature**  
Frequency = 900 MHz

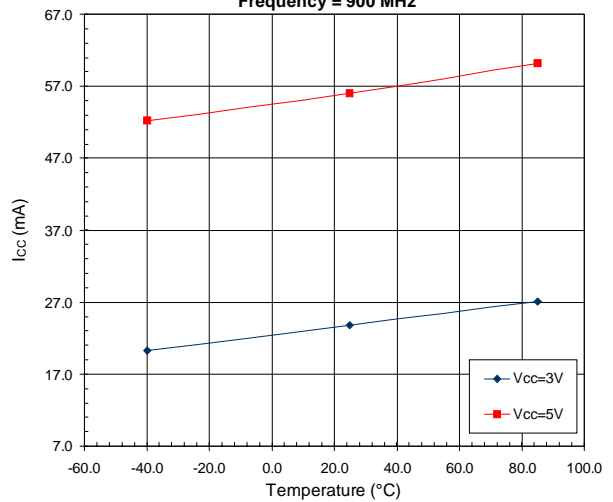

**Gain versus Temperature**  
Frequency = 1950 MHz

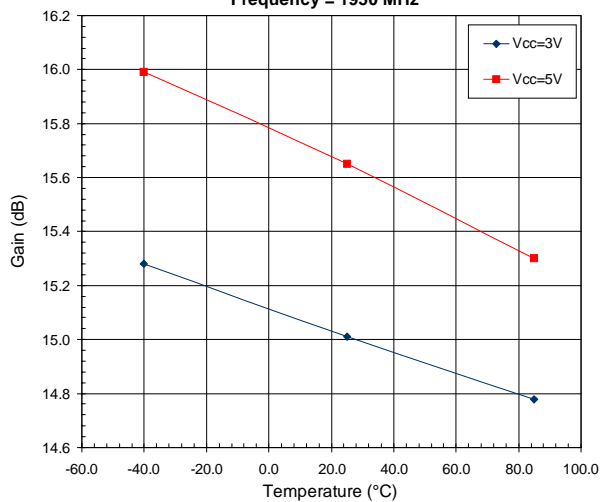

**OIP3 versus Temperature**  
Frequency = 1950 MHz

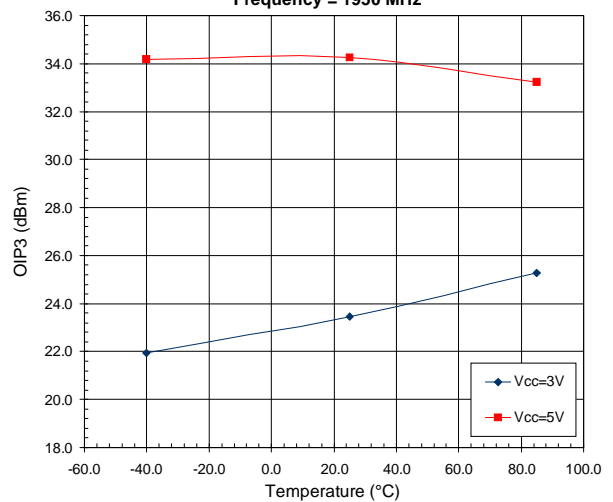

# RF2310

**OP1dB versus Temperature**  
Frequency = 1950 MHz

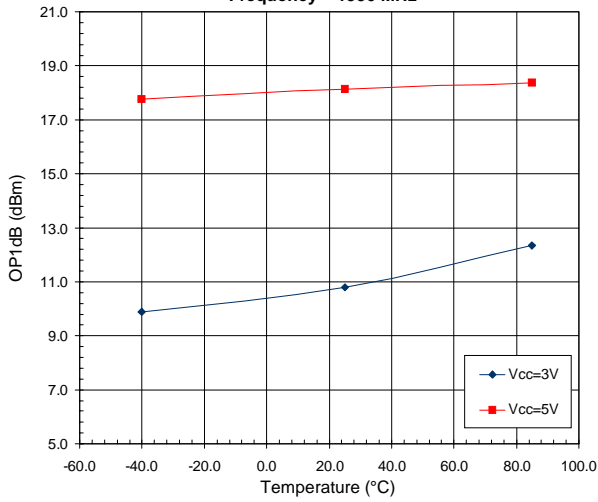

**I<sub>cc</sub> versus Temperature**  
Frequency = 1950 MHz

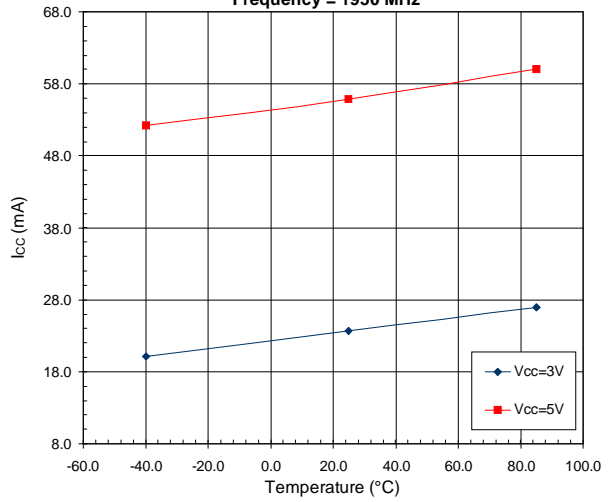

**Gain versus Temperature**  
Frequency = 2450 MHz

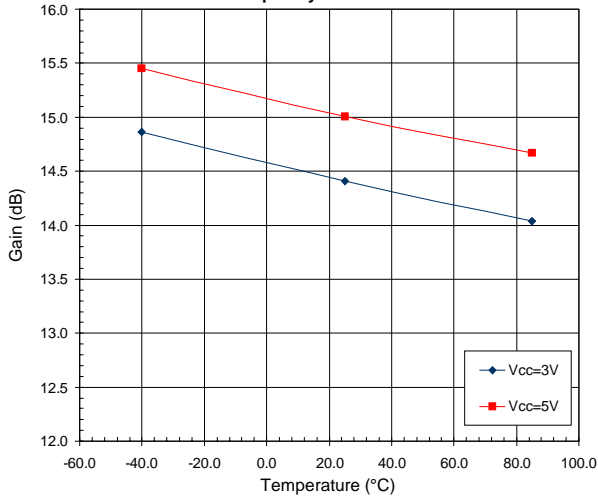

**OIP3 versus Temperature**  
Frequency = 2450 MHz

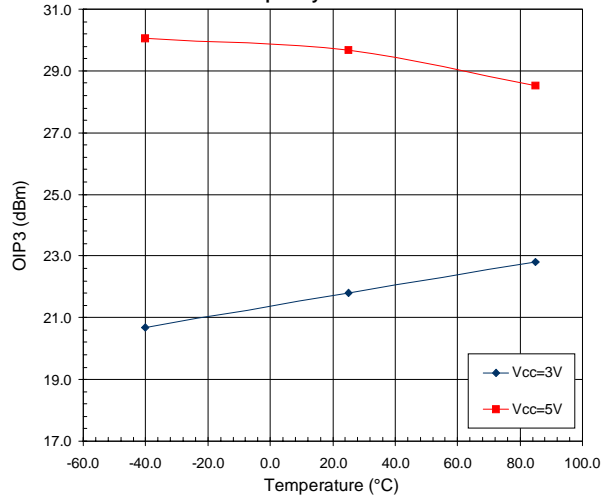

**OP1dB versus Temperature**  
Frequency = 2450 MHz

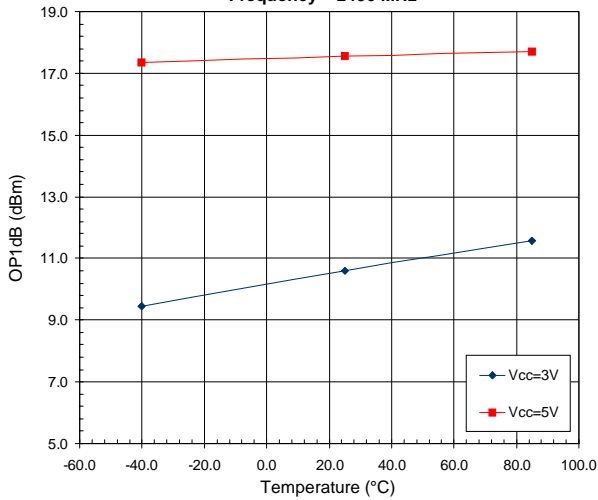

**I<sub>cc</sub> versus Temperature**  
Frequency = 2450 MHz

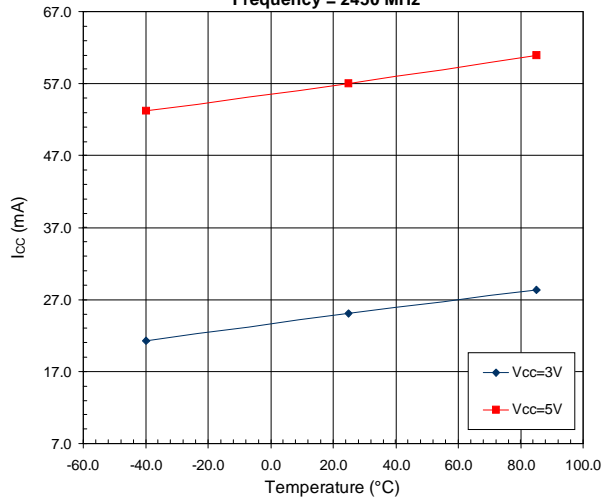

**S11 of Evaluation Board versus Frequency**  
Temperature = +25°C

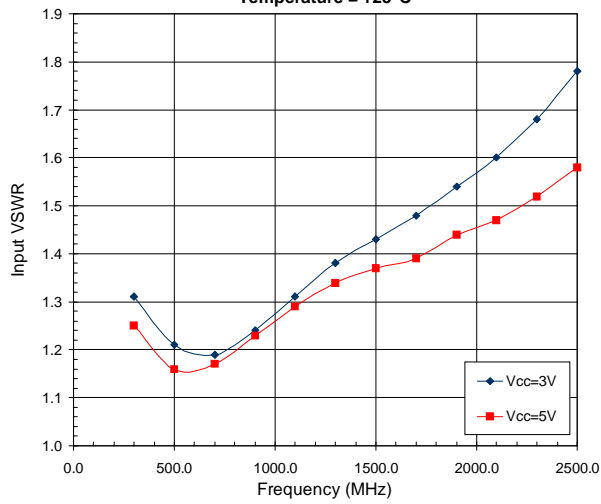

**S22 of Evaluation Board versus Frequency**  
Temperature = +25°C

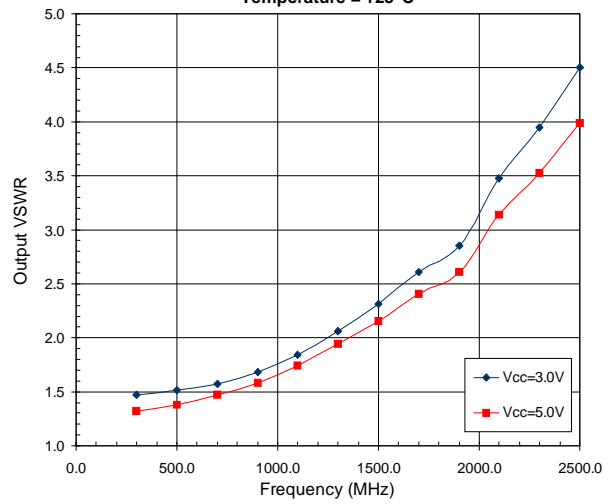

**Reverse Isolation (S12) of Evaluation Board versus Frequency, Temperature = +25°C**

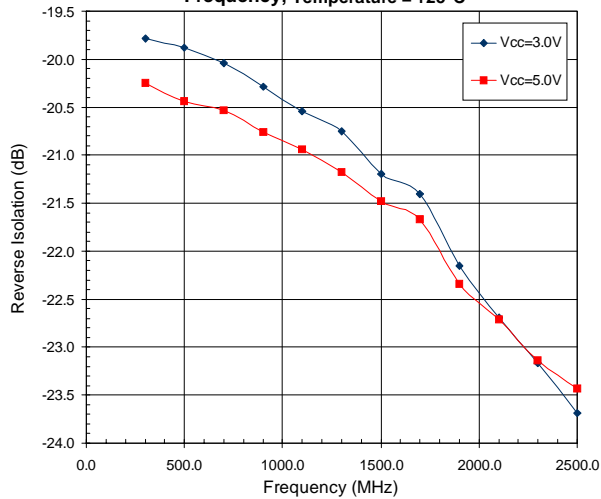

**RF2310**

**4**

**GENERAL PURPOSE  
AMPLIFIERS**