

# 2SA1693

Silicon PNP Epitaxial Planar Transistor (Complement to type 2SC4466)

Application : Audio and General Purpose

**Absolute maximum ratings** (Ta=25°C)

Symbol	2SA1693	Unit
V <sub>CB0</sub>	-80	V
V <sub>CEO</sub>	-80	V
V <sub>EB0</sub>	-6	V
I <sub>C</sub>	-6	A
I <sub>B</sub>	-3	A
P <sub>C</sub>	60(T <sub>C</sub> =25°C)	W
T <sub>J</sub>	150	°C
T <sub>stg</sub>	-55 to +150	°C

**Electrical Characteristics** (Ta=25°C)

Symbol	Conditions	2SA1693	Unit
I <sub>CB0</sub>	V <sub>CB</sub> =-80V	-10max	μA
I <sub>EB0</sub>	V <sub>EB</sub> =-6V	-10max	μA
V <sub>(BR)CEO</sub>	I <sub>C</sub> =-50mA	-80min	V
h <sub>FE</sub>	V <sub>CE</sub> =-4V, I <sub>C</sub> =-2A	50min*	
V <sub>CE(sat)</sub>	I <sub>C</sub> =-2A, I <sub>B</sub> =-0.2A	-1.5max	V
f <sub>T</sub>	V <sub>CE</sub> =-12V, I <sub>E</sub> =0.5A	20typ	MHz
COB	V <sub>CB</sub> =-10V, f=1MHz	150typ	pF

\*h<sub>FE</sub> Rank ○(50to 100), P(70to 140), Y(90to 180)

**Typical Switching Characteristics (Common Emitter)**

V <sub>CC</sub> (V)	R <sub>L</sub> (Ω)	I <sub>C</sub> (A)	V <sub>BB1</sub> (V)	V <sub>BB2</sub> (V)	I <sub>B1</sub> (A)	I <sub>B2</sub> (A)	t <sub>on</sub> (μs)	t <sub>stg</sub> (μs)	t <sub>f</sub> (μs)
-30	10	-3	-10	5	-0.3	0.3	0.18typ	1.10typ	0.21typ

**External Dimensions MT-100(TO3P)**

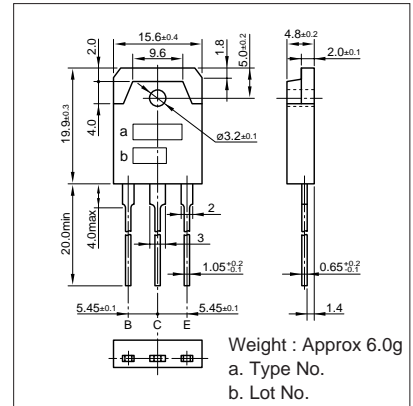

**I<sub>C</sub>-V<sub>CE</sub> Characteristics (Typical)**

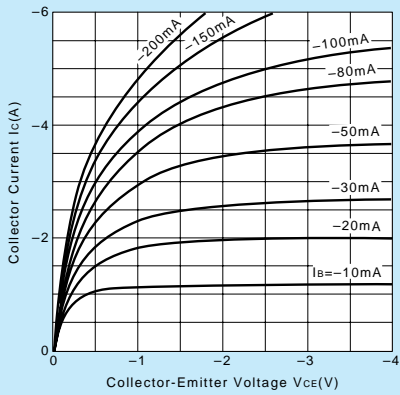

**V<sub>CE(sat)</sub>-I<sub>B</sub> Characteristics (Typical)**

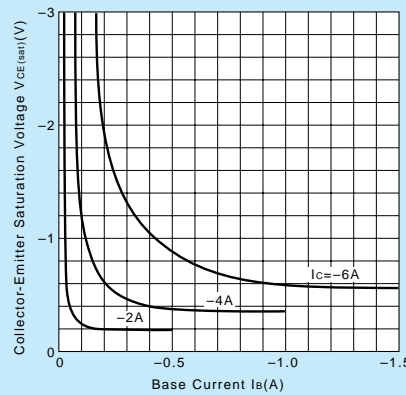

**I<sub>C</sub>-V<sub>BE</sub> Temperature Characteristics (Typical)**

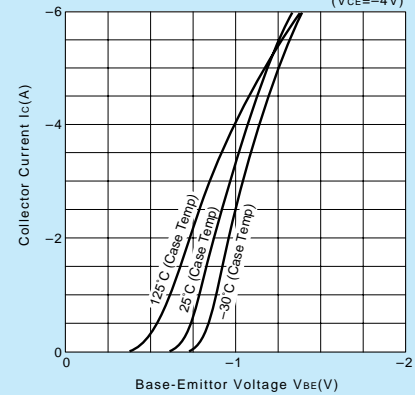

**h<sub>FE</sub>-I<sub>C</sub> Characteristics (Typical)**

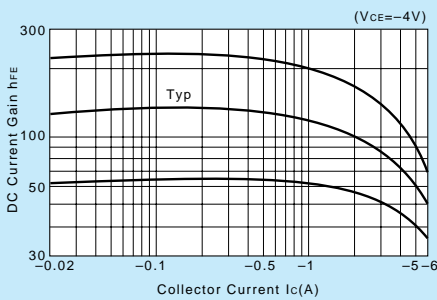

**h<sub>FE</sub>-I<sub>C</sub> Temperature Characteristics (Typical)**

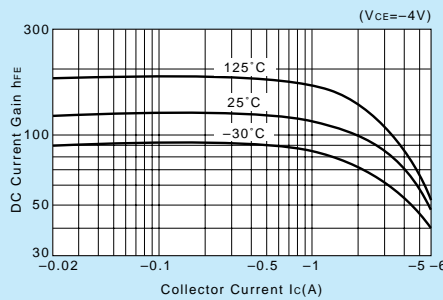

**θ<sub>j-a</sub>-t Characteristics**

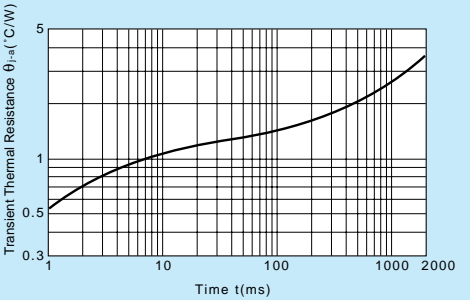

**f<sub>T</sub>-I<sub>E</sub> Characteristics (Typical)**

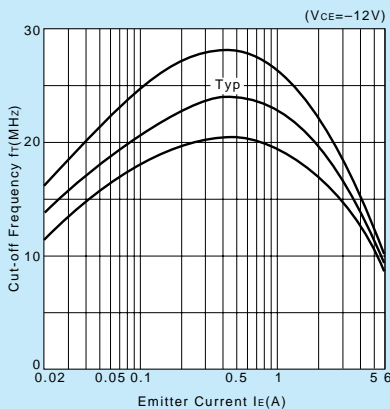

**Safe Operating Area (Single Pulse)**

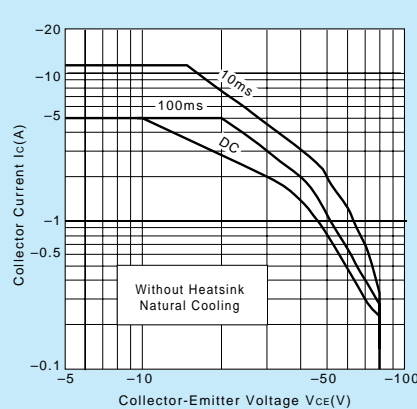

**P<sub>C</sub>-T<sub>a</sub> Derating**

