

**Features**

- -3 dB bandwidth = 85 MHz,  $A_V = 1$
- -3 dB bandwidth = 75 MHz,  $A_V = 2$
- NTSC/PAL dG  $\leq 0.03\%$ , dP  $\leq 0.1^\circ$
- 50 mA output current
- Drives  $\pm 2.5V$  into  $100\Omega$  load
- Low voltage noise =  $4 \text{ nV}/\sqrt{\text{Hz}}$
- Current mode feedback
- Low cost

**Applications**

- Video amplifier
- Video distribution amplifier
- Residue amplifiers in ADC
- Current to voltage converter
- Coaxial cable driver

**Ordering Information**

Part No.	Temp. Range	Pkg.	Outline*
EL2130CN	0°C to +75°C	8-Pin P-DIP	MDP0031
EL2130CS	0°C to +75°C	8-Lead SO	MDP0027

**General Description**

The EL2130 is a wideband current mode feedback amplifier optimized for gains between -10 and +10 while operating on  $\pm 5V$  power supplies. Built using Elantec's Complementary Bipolar process, this device exhibits -3 dB bandwidths in excess of 85 MHz at unity gain and 75 MHz at a gain of two. The EL2130 is capable of output currents in excess of 50 mA giving it the ability to drive either double or single terminated  $50\Omega$  coaxial cables.

Exhibiting a Differential Gain of 0.03% and a Differential Phase of  $0.1^\circ$  at NTSC and PAL frequencies. The EL2130 is an excellent low cost solution to most video applications.

In addition, the EL2130 exhibits very low gain peaking, typically below 0.1 dB to frequencies in excess of 40 MHz as well as 50 ns settling time to 0.2% making it an excellent choice for driving flash A/D converters.

The device is available in the plastic 8-lead narrow-body small outline (SO) and the 8-pin mini DIP packages, and operates over the temperature range of  $0^\circ\text{C}$  to  $+75^\circ\text{C}$ .

**Connection Diagram**

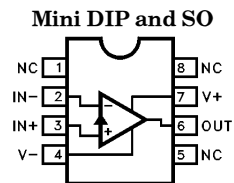

2130-1

Manufactured under U.S. Patent No. 4,893,091.

Note: All information contained in this data sheet has been carefully checked and is believed to be accurate as of the date of publication; however, this data sheet cannot be a "controlled document". Current revisions, if any, to these specifications are maintained at the factory and are available upon your request. We recommend checking the revision level before finalization of your design documentation.

# EL2130C

## 85 MHz Current Feedback Amplifier

### Absolute Maximum Ratings ( $T_A = 25^\circ\text{C}$ )

$V_S$	Supply Voltage	$\pm 6\text{V}$	$I_{OP}$	Output Short Circuit Duration	$\leq 5\text{ sec}$
$V_{IN}$	Input Voltage	$\pm V_S$	$T_A$	Operating Temperature Range:	$0^\circ\text{C to } +75^\circ\text{C}$
$\Delta V_{IN}$	Differential Input Voltage	$\pm 6\text{V}$	$T_J$	Operating Junction Temperature	$150^\circ\text{C}$
$P_D$	Maximum Power Dissipation	See Curves	$T_{ST}$	Storage Temperature	$-65^\circ\text{C to } +150^\circ\text{C}$
$I_{IN}$	Input Current	$\pm 10\text{ mA}$			

#### Important Note:

All parameters having Min/Max specifications are guaranteed. The Test Level column indicates the specific device testing actually performed during production and Quality inspection. Elantec performs most electrical tests using modern high-speed automatic test equipment, specifically the LTX77 Series system. Unless otherwise noted, all tests are pulsed tests, therefore  $T_J = T_C = T_A$ .

Test Level	Test Procedure
I	100% production tested and QA sample tested per QA test plan QCX0002.
II	100% production tested at $T_A = 25^\circ\text{C}$ and QA sample tested at $T_A = 25^\circ\text{C}$ , $T_{MAX}$ and $T_{MIN}$ per QA test plan QCX0002.
III	QA sample tested per QA test plan QCX0002.
IV	Parameter is guaranteed (but not tested) by Design and Characterization Data.
V	Parameter is typical value at $T_A = 25^\circ\text{C}$ for information purposes only.

### Open Loop DC Electrical Characteristics $V_S = \pm 5\text{V}$ ; $R_L = \infty$ , unless otherwise specified

Parameter	Description	Condition	Temp	Min	Typ	Max	Test Level	Units
$V_{OS}$	Input Offset Voltage		$25^\circ\text{C}$	2.0		10	I	mV
			$T_{MIN}, T_{MAX}$			15	III	mV
$\Delta V_{OS}/\Delta T$	Offset Voltage Drift				7		V	$\mu\text{V}/^\circ\text{C}$
$+I_{IN}$	+ Input Current		$25^\circ\text{C}$		5.5	15	I	$\mu\text{A}$
			$T_{MIN}, T_{MAX}$			25	III	$\mu\text{A}$
$-I_{IN}$	+ Input Current		$25^\circ\text{C}$		10	40	I	$\mu\text{A}$
			$T_{MIN}, T_{MAX}$			50	III	$\mu\text{A}$
$+R_{IN}$	+ Input Resistance		$25^\circ\text{C}$	1.0	2.0		I	$\text{M}\Omega$
$C_{IN}$	+ Input Capacitance		$25^\circ\text{C}$		1.0		V	pF
CMRR	Common Mode Rejection Ratio	$V_{CM} = \pm 2.5\text{V}$	$25^\circ\text{C}$	50	60		I	dB
$-ICMR$	Input Current Common Mode Rejection	$V_{CM} = \pm 2.5\text{V}$	$25^\circ\text{C}$		5	10	I	$\mu\text{A}/\text{V}$
			$T_{MIN}, T_{MIN}$			20	III	$\mu\text{A}/\text{V}$
PSRR	Power Supply Rejection Ratio	$\pm 4.5\text{V} \leq V_S \leq \pm 6\text{V}$	$25^\circ\text{C}$	60	70		I	dB
$+IPSR$	+ Input Current Power Supply Rejection	$\pm 4.5\text{V} \leq V_S \leq \pm 6\text{V}$	$25^\circ\text{C}$		0.1	0.5	I	$\mu\text{A}/\text{V}$
			$T_{MIN}, T_{MIN}$			1.0	III	$\mu\text{A}/\text{V}$
$-IPSR$	- Input Current Power Supply Rejection	$\pm 4.5\text{V} \leq V_S \leq \pm 6\text{V}$	$25^\circ\text{C}$		0.5	5.0	I	$\mu\text{A}/\text{V}$
			$T_{MIN}, T_{MIN}$			8.0	III	$\mu\text{A}/\text{V}$

# EL2130C

## 85 MHz Current Feedback Amplifier

### Open Loop DC Electrical Characteristics

$V_S = \pm 5V$ ;  $R_L = \infty$ , unless otherwise specified — Contd.

Parameter	Description	Condition	Temp	Min	Typ	Max	Test Level	Units
R <sub>OL</sub>	Transimpedance	V <sub>OUT</sub> = ±2.5V, R <sub>L</sub> = 100Ω	25°C	80	145		I	V/mA
			T <sub>MIN</sub> , T <sub>MAX</sub>	70			III	V/mA
A <sub>VOL</sub>	Open Loop DC Voltage Gain	V <sub>OUT</sub> = ±2.5V, R <sub>L</sub> = 100Ω	25°C	60	66		I	dB
			T <sub>MIN</sub> , T <sub>MAX</sub>	56			III	dB
V <sub>O</sub>	Output Voltage Swing	R <sub>L</sub> = 100Ω	25°C	3	3.5		I	V
I <sub>OUT</sub>	Output Current		25°C	30	50		I	mA
R <sub>OUT</sub>	Output Resistance		25°C		5		V	Ω
I <sub>S</sub>	Quiescent Supply Current		Full		17	21	I	mA
I <sub>SC</sub>	Short Circuit Current		25°C		85		V	mA

### Closed Loop AC Electrical Characteristics

$V_S = \pm 5V$ ,  $A_V = +2$ ,  $R_F = R_G = 820\Omega$ ,  $R_L = 100\Omega$ ,  $T_A = 25^\circ C$

Parameter	Description	Condition	Min	Typ	Max	Test Level	Units
SR	Slew Rate (Note 1)	V <sub>O</sub> = 5 V <sub>p-p</sub>		625		V	V/μs
t <sub>r</sub>	Rise Time	V <sub>O</sub> = 200 mV		4.6		V	ns
t <sub>f</sub>	Fall Time	V <sub>O</sub> = 200 mV		4.6		V	ns
t <sub>pd</sub>	Prop Delay	V <sub>O</sub> = 200 mV		4.0		V	ns
SSBW	3 dB Bandwidth	V <sub>O</sub> = 100 mV		75		V	MHz
dG	NTSC/PAL Diff Gain			0.03		V	%
dP	NTSC/PAL Diff Phase			0.10		V	deg (°)
GFPL	Gain Flatness	f < 40 MHz		0.08		V	dB

Note 1: Slew rate is measured with V<sub>O</sub> = 5V<sub>p-p</sub> between -1.25V and +1.25V and +1.25V and -1.25V.

# EL2130C

## 85 MHz Current Feedback Amplifier

### Typical Performance Curves

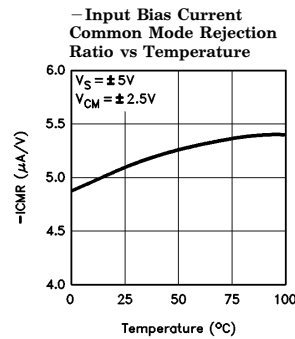
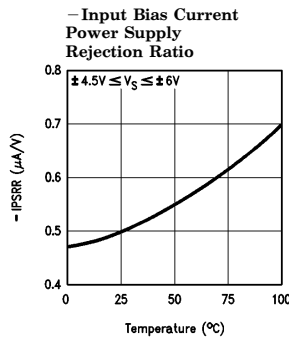
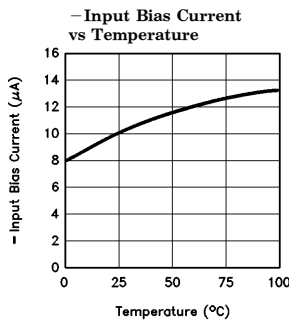
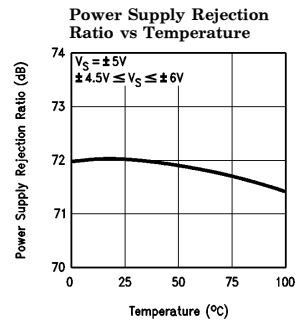
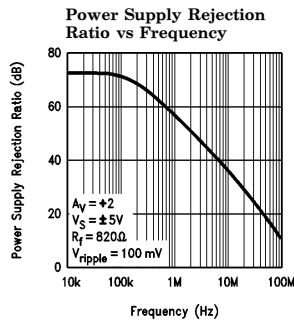
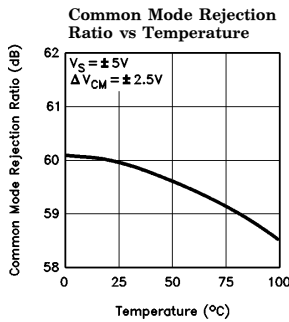
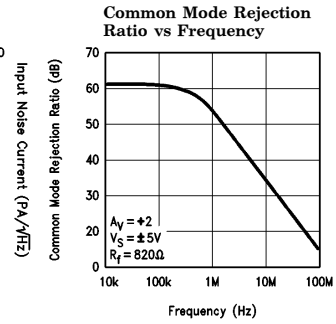
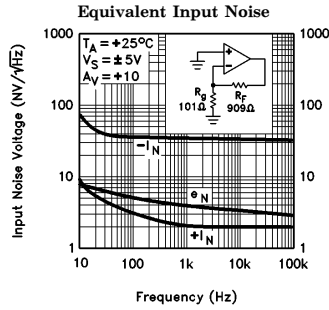
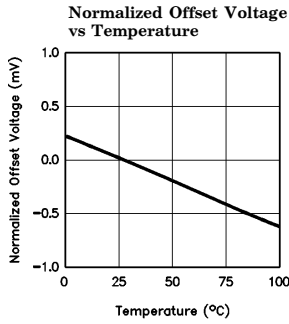

2130-2

# EL2130C

## 85 MHz Current Feedback Amplifier

### Typical Performance Curves — Contd.

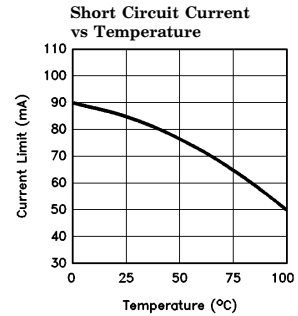
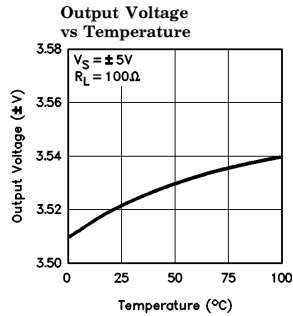
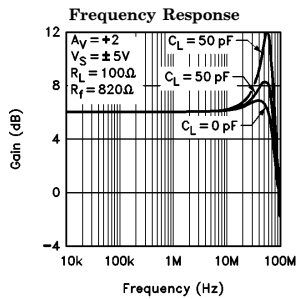
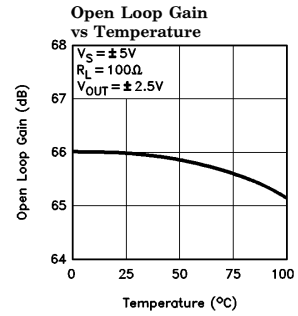
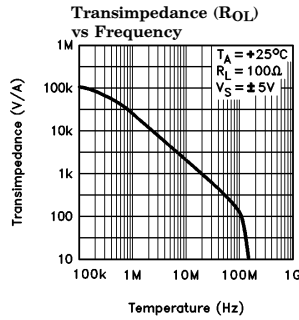
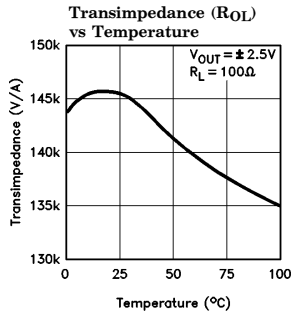
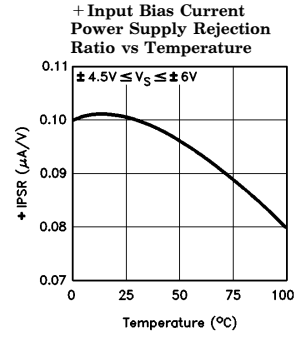
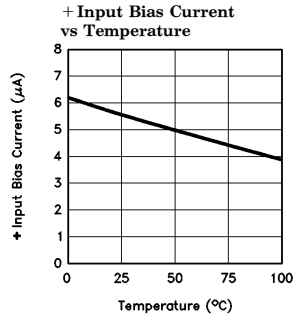
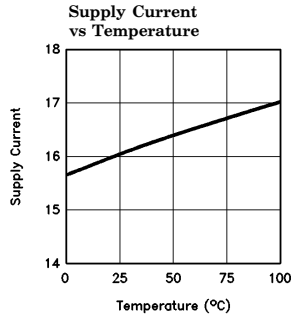

2130-3

# EL2130C

## 85 MHz Current Feedback Amplifier

### Typical Performance Curves — Contd.

Large Signal Response

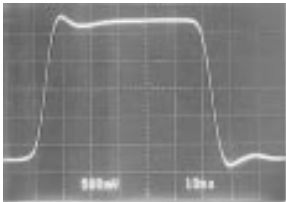

2130-4

$A_V = +1$ ,  $R_F = 820\Omega$   
 $R_L = 100\Omega$ ,  $C_L = 12\text{ pF}$

Large Signal Response

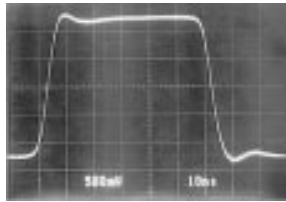

2130-5

$A_V = +2$ ,  $R_F = 820\Omega$   
 $R_L = 100\Omega$ ,  $C_L = 12\text{ pF}$

Small Signal Response

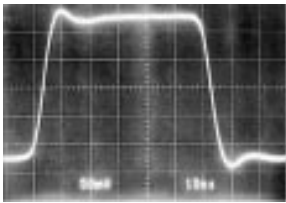

2130-7

$A_V = +1$ ,  $R_F = 820\Omega$   
 $R_L = 100\Omega$ ,  $C_L = 12\text{ pF}$

Small Signal Response

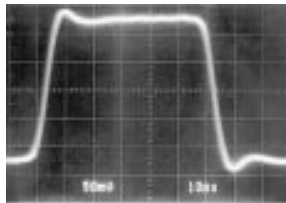

2130-8

$A_V = +2$ ,  $R_F = 820\Omega$   
 $R_L = 100\Omega$ ,  $C_L = 12\text{ pF}$

Long-Term Output Settling Error vs Time,  $V_S = \pm 5V$

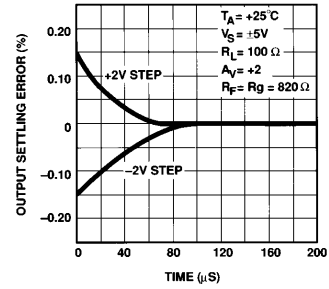

2130-6

Short Term Output Settling Error vs Time,  $V_S = \pm 5V$

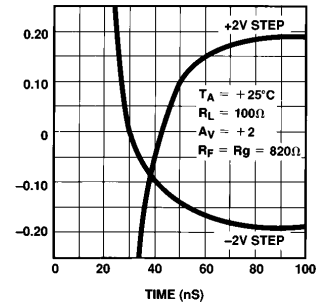

2130-9

# EL2130C

## 85 MHz Current Feedback Amplifier

### Typical Performance Curves — Contd.

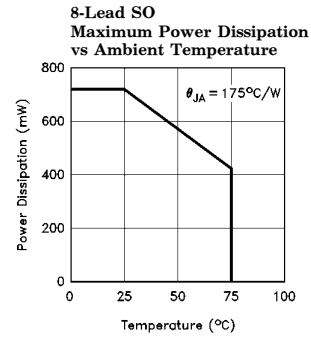
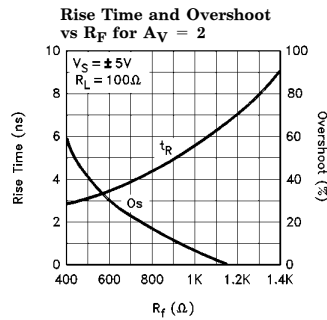
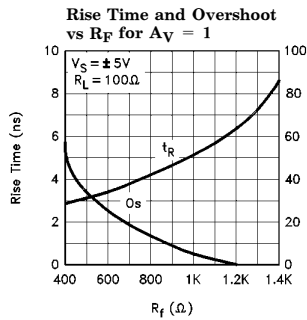
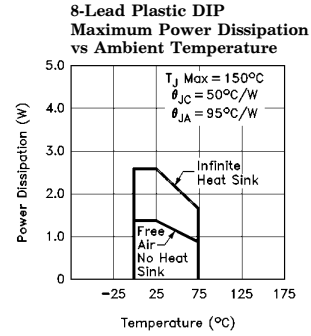
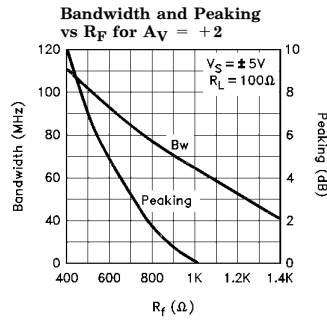
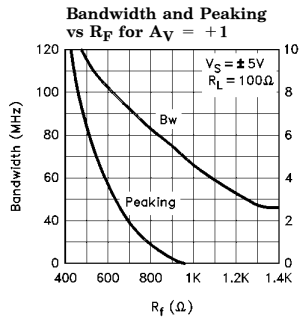

2130-10

### Applications Information

#### Power Supply Bypassing

The EL2130 will exhibit ringing or oscillation if the power supply leads are not adequately bypassed. 0.1  $\mu\text{F}$  ceramic disc capacitors are suggested for both supply pins at a distance no greater than  $\frac{1}{2}$  inch from the device. Surface mounting chip capacitors are strongly recommended.

#### Lead Dress

A ground plane to which decoupling capacitors and gain setting resistors are terminated will eliminate overshoot and ringing. However, the ground plane should not extend to the vicinity of both the non-inverting and inverting inputs (pins 3 and 2) which would add capacitance to these nodes, and lead lengths from these pins should be made as short as possible.

Use of sockets, particularly for the SO package, should be avoided if possible. Sockets add parasitic inductance and capacitance which will result in peaking and overshoot.

#### Video Characteristics and Applications

Frequency domain testing is performed at Elantec using a computer controlled HP model 8656B Signal Generator and an HP Model 4195A Network/Spectrum Analyzer. The DUT test board is built using microwave/strip line techniques, and solid coaxial cables route the stimulus to the DUT socket. Signals are routed to and from the DUT test fixture using subminiature coaxial cable.

Differential Gain and Phase are tested at a noise gain of 2 with 100 $\Omega$  load. Gain and Phase measurements are made with a DC input reference

# EL2130C

## 85 MHz Current Feedback Amplifier

### Applications Information — Contd.

voltage at 0V and compared to those made at  $V_{ref}$  equal to 0.7V at frequencies extending to 30 MHz.

The EL2130 is capable of driving  $100\Omega$  to a minimum of 2.5V peak which means that it can naturally drive double terminated ( $50\Omega$ ) coaxial cables.

### Capacitive Loads

As can be seen from the Bode plot, the EL2130 will peak into capacitive loads greater than 20 pf. In many applications such as flash A/D's, capacitive loading is unavoidable. In these cases, the use of a snubber network consisting of a  $100\Omega$  resistor in series with 47 pF capacitor from the output to ground is recommended.

### Equivalent Circuit

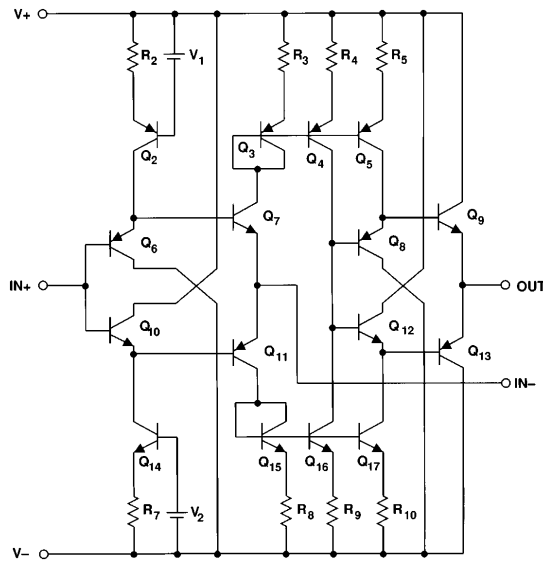

2130-11

### AC Test Circuit

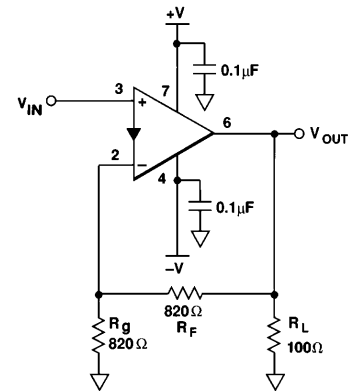

2130-12

### General Disclaimer

Specifications contained in this data sheet are in effect as of the publication date shown. Elantec, Inc. reserves the right to make changes in the circuitry or specifications contained herein at any time without notice. Elantec, Inc. assumes no responsibility for the use of any circuits described herein and makes no representations that they are free from patent infringement.

**élan**tec  
HIGH PERFORMANCE ANALOG INTEGRATED CIRCUITS

### Elantec, Inc.

1996 Tarob Court

Milpitas, CA 95035

Telephone: (408) 945-1323

(800) 333-6314

Fax: (408) 945-9305

European Office: 44-71-482-4596

### WARNING — Life Support Policy

Elantec, Inc. products are not authorized for and should not be used within Life Support Systems without the specific written consent of Elantec, Inc. Life Support systems are equipment intended to support or sustain life and whose failure to perform when properly used in accordance with instructions provided can be reasonably expected to result in significant personal injury or death. Users contemplating application of Elantec, Inc. products in Life Support Systems are requested to contact Elantec, Inc. factory headquarters to establish suitable terms & conditions for these applications. Elantec, Inc.'s warranty is limited to replacement of defective components and does not cover injury to persons or property or other consequential damages.